

---

# Aids to Navigation Manual - Seamanship





# Table of Contents

---

<b>LIST OF FIGURES</b>	<b>ix</b>
<b>LIST OF TABLES</b>	<b>xi</b>
<b>LIST OF ACRONYMS</b>	<b>xii</b>
<b>GLOSSARY</b>	<b>xiii</b>
<b>CHAPTER 1 INTRODUCTION.....</b>	<b>1-1</b>
SECTION A. WARNINGS, CAUTIONS, AND NOTES .....	1-3
A.1. Warning.....	1-3
A.2. Caution.....	1-3
A.3. Note.....	1-3
A.4. Non-Mandatory Procedures .....	1-3
SECTION B. ATON MANUAL VOLUMES .....	1-5
SECTION C. CHANGES.....	1-7
SECTION D. ACTION.....	1-9
Introduction.....	1-9
D.1. Configuration Control.....	1-9
<b>CHAPTER 2 TRAINING AND CERTIFICATION.....</b>	<b>2-1</b>
SECTION A. PROGRESSION OF CERTIFICATION .....	2-3
A.1. Buoy Deck Progression.....	2-3
A.2. Construction Deck Progression.....	2-3
A.3. Initial Certification.....	2-3
A.4. Same Class Follow-On Tours .....	2-3
A.5. Previously Certified on Different Classes.....	2-4
SECTION B. TRAINING GUIDES .....	2-5
B.1. Guide Hierarchy .....	2-5
B.2. ATON Related PQS .....	2-5
B.3. ATON Courses.....	2-6
<b>CHAPTER 3 PERSONNEL PROTECTIVE EQUIPMENT, PROTECTIVE CLOTHING, AND SAFETY PROCEDURES .....</b>	<b>3-1</b>
SECTION A. PERSONNEL PROTECTIVE EQUIPMENT (PPE) AND PROTECTIVE CLOTHING .....	3-3
A.1. ATON Crew Protective Clothing.....	3-3
A.2. Hardhats .....	3-4
A.3. Personal Flotation Devices.....	3-5
A.4. Gloves .....	3-5
A.5. <b>Safety Glasses / Goggles</b> .....	3-6
A.6. Safety Footwear .....	3-6



- A.7. Acid Resistant Rubber Aprons..... 3-6
- A.8. Respirators ..... 3-6
- A.9. Additional Gear..... 3-6
- SECTION B. SAFETY PROCEDURES ..... 3-9
  - B.1. ORM and Team Coordination..... 3-9
  - B.2. General Safety ..... 3-10
  - B.3. Open Hatches ..... 3-11
  - B.4. **Cutting Torch / Cutoff Machine** ..... 3-11
- SECTION C. PRESSURE TREATED PILES..... 3-13
  - C.1. Chromated Copper Arsenate ..... 3-13
  - C.2. Health Concerns ..... 3-13
  - C.3. Creosote..... 3-14
- SECTION D. DIVING OPERATIONS ..... 3-15

**CHAPTER 4 ATON RIGGING, LOOSE GEAR CARGO, LOAD SECURING EQUIPMENT, AND DECK TOOLS..... 4-1**

- SECTION A. REGISTRY OF LIFTING APPLIANCES INFORMATION ..... 4-3
  - A.1. NATON Website..... 4-3
  - A.2. Requirements ..... 4-3
- SECTION B. FIBER AND WIRE ROPE ..... 4-5
  - B.1. Fiber Rope ..... 4-5
  - B.2. Wire Rope Construction..... 4-5
  - B.3. Physical Properties ..... 4-13
  - B.4. Designations ..... 4-14
  - B.5. Installation and Selection ..... 4-14
  - B.6. Rigging Considerations ..... 4-17
  - B.7. Lubrication ..... 4-19
  - B.8. **Inspection / Replacement**..... 4-19
  - B.9. End Fittings ..... 4-20
- SECTION C. LOOSE CARGO GEAR ..... 4-25
  - C.1. Blocks..... 4-25
  - C.2. Tackle ..... 4-26
  - C.3. Swivel..... 4-27
  - C.4. Various Rigging Links ..... 4-27
  - C.5. Hooks ..... 4-28
  - C.6. Pelican Hooks..... 4-28
  - C.7. Shackles..... 4-29
  - C.8. Chain ..... 4-30
  - C.9. **Tag / Steadying Lines**..... 4-32
  - C.10. Cage Line ..... 4-32
  - C.11. Slings..... 4-33
- SECTION D. LOAD SECURING EQUIPMENT ..... 4-37
  - D.1. Equipment ..... 4-37
  - D.2. Procedures ..... 4-38



SECTION E. DECK TOOLS .....	4-39
E.1. Line Reeving Device .....	4-39
E.2. Chain Hooks .....	4-39
E.3. Hammers.....	4-40
E.4. Anvil.....	4-41
E.5. Swede Wrench.....	4-41
E.6. Splitter Bar.....	4-41
E.7. Peavey Hooks .....	4-42
E.8. Grapnel Hooks.....	4-42
E.9. Bull Chain.....	4-42
<b>CHAPTER 5 LOADING AND UNLOADING AIDS TO NAVIGATION GEAR.....</b>	<b>5-1</b>
SECTION A. PLANNING, PREPARATION, AND SAFETY.....	5-3
A.1. Loading Plan .....	5-3
A.2. Reponsibilities.....	5-3
A.3. Safety .....	5-4
SECTION B. LOADING, UNLOADING, AND SECURING ATON EQUIPMENT.....	5-5
B.1. Loading Buoys .....	5-5
B.2. ATON Equipment .....	5-5
B.3. Fundamentals of Stowage .....	5-6
B.4. Buoy Stowage .....	5-7
<b>CHAPTER 6 ATON OPERATIONS IN ICE .....</b>	<b>6-1</b>
SECTION A. ATON OPERATIONS IN ICE .....	6-3
A.1. Considerations .....	6-3
A.2. Working in Ice.....	6-4
A.3. A Buoy Alongside in Moving Ice .....	6-5
A.4. Towing Buoys in Ice.....	6-6
A.5. Sinkers on Ice Buoys .....	6-7
<b>CHAPTER 7 GENERAL STABILITY .....</b>	<b>7-1</b>
SECTION A. STABILITY .....	7-3
A.1. Buoyancy .....	7-3
A.2. Center of Gravity .....	7-3
A.3. Equilibrium .....	7-4
A.4. Metracentric Height .....	7-4
SECTION B. STABILITY AND LOADING DATA BOOKLET.....	7-7
B.1. Limiting KGv Curves.....	7-7
B.2. Draft And Trim.....	7-8
B.3. Lifting Capacity Curves .....	7-8
B.4. Liquid Loading Instructions .....	7-9
B.5. Load Conditions .....	7-9
B.6. Trim Table.....	7-9



- B.7. Change in KG Diagram..... 7-11
- B.8. Grounding..... 7-12
- B.9. Procedures After Damage ..... 7-13
- B.10 Initial Action After Damage..... 7-13
- SECTION C. CORRECTIVE PROCEDURES..... 7-15
  - C.1. Recognizing Reduced Stability ..... 7-15
  - C.2. Reducing the Danger of Capsizing..... 7-15
- SECTION D. FLOODING AND CASUALTY CONTROL SOFTWARE (FCCS)..... 7-17
  - D.1. Loading Conditions..... 7-17
  - D.2. CO Summary Screen..... 7-17
  - D.3. Stability Summary Screen..... 7-17
  - D.4. Flooding ..... 7-17
  - D.5. Lifting Operations ..... 7-18
  - D.6. Grounding ..... 7-18
  - D.7. Icing ..... 7-18

**CHAPTER 8 SHIPHANDLING AND BOATHANDLING TECHNIQUES..... 8-1**

- SECTION A. GENERAL..... 8-2
  - A.1. Shiphandling in ATON Work ..... 8-2
  - A.2. Providing Development Opportunities ..... 8-2
  - A.3. ORM and TCT ..... 8-2
  - A.4. Briefings and Debriefings ..... 8-3
- SECTION B. SHIPHANDLING AND MANUEVERING ..... 8-4
  - B.1. Speed ..... 8-4
  - B.2. Know Your Cutter..... 8-4
  - B.3. Approaches to a Buoy ..... 8-5
  - B.4. Stoppers..... 8-6
  - B.5. Priority..... 8-6
  - B.6. Dredging the Anchor to Work Buoys ..... 8-6
  - B.7. Kedging the Anchor ..... 8-7
- SECTION C. WLBB, WLB, AND WLM TENDERS ..... 8-9
  - C.1. WLBB Shiphandling Considerations..... 8-9
  - C.2. WLB Shiphandling Considerations..... 8-12
  - C.3. WLM Shiphandling Considerations..... 8-15
- SECTION D. CONSTRUCTION TENDERS..... 8-17
  - D.1. WLIC Considerations ..... 8-17
- SECTION E. **RIVER TENDERS** ..... 8-19
  - E.1. WLR Considerations ..... 8-19
  - E.2. Flanking Rudders..... 8-20

**CHAPTER 9 SEAGOING AND COASTAL BUOY TENDER OPERATIONS..... 9-1**

- SECTION A. GENERAL INFORMATION..... 9-3
  - A.1. WLB and WLBB Crane Description ..... 9-3



A.2. WLM Crane Description..... 9-4

A.3. Deck Winches ..... 9-5

A.4. Chain Inhaul Winch ..... 9-5

SECTION B. STANDARD EVOLUTION ..... 9-7

    B.1. Deck Set Up ..... 9-7

    B.2. Bringing the Buoy Onboard ..... 9-8

    B.3. Hoisting Chain and Sinker ..... 9-12

    B.4. Deploying Chain and Sinker ..... 9-14

    B.5. Deploying Buoy with Inhaul Winch ..... 9-15

SECTION C. SPECIAL EVOLUTIONS..... 9-19

    C.1. Buoy Operations Without the Inhaul Winch..... 9-19

    C.2. Recovery of a Sunken Buoy..... 9-23

    C.3. Recovery of Buoys Ashore ..... 9-29

    C.4. Damaged Lifting Bails ..... 9-30

**CHAPTER 10 INLAND BUOY TENDER OPERATIONS..... 10-1**

    SECTION A. GENERAL INFORMATION..... 10-3

        A.1. 100’ WLI Crane Information ..... 10-3

        A.2. 65’ WLI Crane Information ..... 10-3

        A.3. Crossdeck Winch Information ..... 10-4

        A.4. Spuds..... 10-4

    SECTION B. STANDARD BUOY EVOLUTION..... 10-5

        B.1. Planning and Preparation ..... 10-5

        B.2. The Approach..... 10-5

        B.3. Hoisting a Buoy Aboard..... 10-6

        B.4. Pulling Buoy Chain ..... 10-8

        B.5. Bringing the Sinker Aboard ..... 10-10

        B.6. Hanging the Sinker..... 10-11

        B.7. Setting the Sinker and Buoy..... 10-12

    SECTION C. SPECIAL EVOLUTIONS..... 10-15

        C.1. Planning and Preparation ..... 10-15

        C.2. Fouled Mooring Chain ..... 10-15

        C.3. Damaged or Missing Lifting Bails..... 10-16

        C.4. Dragging for and Recovering Sunken Buoys..... 10-17

        C.5. Buoys Washed Ashore ..... 10-23

**CHAPTER 11 RIVER BUOY TENDER OPERATIONS ..... 11-1**

    SECTION A. GENERAL INFORMATION..... 11-3

        A.1. Buoy Handling Equipment..... 11-3

        A.2. Pooled Water..... 11-4

        A.3. Fast Water ..... 11-4

        A.4. Buoys and Equipment ..... 11-4

        A.5. Deck Equipment..... 11-7



SECTION B. STANDARD BUOY EVOLUTION..... 11-9

- B.1. Planning and Preparation ..... 11-9
- B.2. The Approach..... 11-9
- B.3. Inspection of Buoy Hull, Mooring, and Appendages..... 11-13
- B.4. Setting the Buoy with a Jet Pipe..... 11-13
- B.5. Recovering Jet Pipe Moorings ..... 11-16
- B.6. Setting a Buoy Using Wire and a Sinker..... 11-17
- B.7. Setting a Buoy Using a Chain and a Sinker ..... 11-18
- B.8. Positioning..... 11-19
- B.9. Dragging a Buoy ..... 11-20

SECTION C. SPECIAL EVOLUTIONS..... 11-21

- C.1. Deviation from Standard Procedures ..... 11-21
- C.2. Fouled Mooring Chain ..... 11-21
- C.3. Recovery of Stray or Stranded Buoys ..... 11-22

SECTION D. ATON WORK ASHORE..... 11-23

- D.1. Shore Aid Location and Servicing Tasks..... 11-23
- D.2. Shore Aid Survivability ..... 11-23
- D.3. Building Shore Structures ..... 11-23
- D.4. Hazards and Wildlife Encountered During Servicing..... 11-25

SECTION E. CUTTER BOAT OPERATIONS ..... 11-27

- E.1. General Precautions..... 11-27
- E.2. Crew Requirements ..... 11-27
- E.3. Floating Buoy Task List ..... 11-27
- E.4. Beached Buoy Task List..... 11-28

**CHAPTER 12 INLAND CONSTRUCTION TENDER OPERATIONS ..... 12-1**

SECTION A. BASIC CONSTRUCTION EQUIPMENT, MATERIALS ..... 12-3

- A.1. Crane Characteristics and Description ..... 12-3
- A.2. Crossdeck Winches ..... 12-5
- A.3. Diesel Powered Pile-Driving Hammer ..... 12-6
- A.4. Vibratory Pile Extractor/Driver ..... 12-6
- A.5. Spuds ..... 12-6

SECTION B. CONSTRUCTION DECK EVOLUTION..... 12-7

- B.1. Pile Loading ..... 12-7
- B.2. The Approach..... 12-7
- B.3. Depth of Water ..... 12-8
- B.4. Determining the Pile Length ..... 12-8
- B.5. The Evolution ..... 12-8
- B.6. Cutting Pile Tops After Driving..... 12-10
- B.7. Pile Driving and Structure Considerations..... 12-11
- B.8. Jetting ..... 12-12
- B.9. Completing the Structure ..... 12-12

SECTION C. SPECIAL EVOLUTIONS..... 12-13

- C.1. Buoy Recovery Operations ..... 12-13



C.2. Buoy Setting Operations .....	12-14
C.3. Wreckage.....	12-15
C.4. Wire Sweeping .....	12-16
C.5. Recovering Wreckage .....	12-16
<b>CHAPTER 13 WTGB WITH BARGE ATON OPERATIONS.....</b>	<b>13-1</b>
SECTION A. GENERAL INFORMATION.....	13-3
A.1. Crane Characteristics .....	13-3
A.2. Deck Winches .....	13-3
SECTION B. STANDARD BUOY EVOLUTION.....	13-5
B.1. Prior to Work.....	13-5
B.2. The Approach.....	13-5
B.3. The Evolution.....	13-5
B.4. Pulling Buoy Chain .....	13-7
B.5. Bringing the Sinker Aboard .....	13-9
B.6. Hanging the Sinker.....	13-10
B.7. Setting the Buoy .....	13-10
SECTION C. SPECIAL EVOLUTIONS.....	13-13
C.1. Fouled Mooring Chain .....	13-13
C.2. Damaged Lifting Bails .....	13-14
C.3. Recovery of Sunken Buoys .....	13-15
C.4. Dragging Operations .....	13-15
C.5. Conning Tips.....	13-17
C.6. Snagging a Submerged Object.....	13-17
C.7. Recovery of Buoys Ashore .....	13-21
<b>CHAPTER 14 ATON OPERATIONS FROM BOATS .....</b>	<b>14-1</b>
SECTION A. GENERAL BOAT INFORMATION .....	14-3
<b>A.1. Standard Boats.....</b>	<b>14-3</b>
<b>A.2. Non-Standard Boats.....</b>	<b>14-3</b>
<b>A.3. Training and Qualification.....</b>	<b>14-3</b>
<b>A.4. Boat Seamanship.....</b>	<b>14-3</b>
<b>A.5. Special Considerations.....</b>	<b>14-3</b>
SECTION B. PERSONNEL DEPLOYMENT .....	14-5
<b>B.1. Floating Aids.....</b>	<b>14-5</b>
<b>B.2. Fixed Aids.....</b>	<b>14-6</b>
<b>B.3. Shore Aids .....</b>	<b>14-7</b>
SECTION C. TOWING BUOYS WITH BOATS.....	14-9
<b>C.1. Floating Buoys.....</b>	<b>14-9</b>
<b>C.2. Grounded Buoys.....</b>	<b>14-9</b>
<b>C.3. Towing Buoys with Moorings Attached.....</b>	<b>14-10</b>
SECTION D. WIRE SWEEPING WITH BOATS .....	14-13
<b>D.1. Overview .....</b>	<b>14-13</b>





<b>D.2. Sweeping with One Boat.....</b>	<b>14-14</b>
<b>D.3. Sweeping with Two Boats.....</b>	<b>14-15</b>
<b>SECTION E. BUOY OPERATIONS FROM BOATS .....</b>	<b>14-17</b>
<b>E.1. Overview .....</b>	<b>14-17</b>
<b>E.2. Recovering the Buoy .....</b>	<b>14-17</b>
<b>E.3. Setting the Buoy.....</b>	<b>14-18</b>
<b>E.4. Precautions.....</b>	<b>14-18</b>
<b>APPENDIX A ATON DECK SAFETY BRIEF</b>	<b>A-1</b>
<b>APPENDIX B CRANE SIGNALS</b>	<b>B-1</b>



## List of Figures

Figure 3-1	Hardhat	3-4
Figure 3-2	Gloves	3-5
Figure 3-3	Clear Safety Glasses	3-7
Figure 3-4	Tinted Safety Glasses	3-7
Figure 3-5	Safety Boots	3-7
Figure 3-6	Rubber Gloves and Apron	3-7
Figure 3-7	Sample Respirator	3-7
Figure 3-8	Sample Respirator	3-7
Figure 4-1	Assorted Wire Rope Classifications	4-8
Figure 4-2	Wire Rope Lays	4-10
Figure 4-3	Cross Sections of Rotation Resistant Wire Rope	4-11
Figure 4-4	The <b>incorrect</b> and correct way of measuring wire rope.	4-12
Figure 4-5	Lay Length	4-13
Figure 4-6	Proper Method of Locating Rope Anchorage Point on a Drum	4-16
Figure 4-7	The Correct and Incorrect <b>Way</b> to Wind Wire Rope from Reel to Drum	4-16
Figure 4-8	Efficiency and D to d <b>Ratio</b> Graph	4-17
Figure 4-9	Drum to Sheave Distance Table	4-19
Figure 4-10	Fleet Angle Drawing	4-19
Figure 4-11	Wire Rope Seizing	4-21
Figure 4-12	Feige Fitting Assembly	4-21
Figure 4-13	Sample Wedge Socket Installation	4-23
Figure 4-14	Wire Rope Installation Process	4-24
Figure 4-15	Sample Block and Tackle Arrangements	4-27
Figure 4-16	Pelican Hook	4-29
Figure 4-17	Modeer Shackle	4-30
Figure 4-18	Open Link Chain	4-30
Figure 4-19	Stud Link Chain	4-31
Figure 4-20	Buoy Chain Bundles	4-31
Figure 4-21	Sample Gripe Chain Assemblies	4-31
Figure 4-22	Retrival Cage Line	4-33
Figure 4-23	Deployment Cage Line	4-33
Figure 4-24	Assorted Chain Slings	4-34
Figure 4-25	Load Angle Examples	4-35
Figure 4-26	Ratchet Binder	4-37
Figure 4-27	Ratchet Binder and Pneumatic Tensor	4-37
Figure 4-28	Saddle	4-38
Figure 4-29	Saddle and Head Block	4-38
Figure 4-30	Line Reeving Device	4-40
Figure 4-31	Hammers and Chain Hooks	4-40
Figure 4-32	Assorted Hammers	4-41
Figure 4-33	Assorted Deck Tools	4-41
Figure 4-34	Anvil	4-41
Figure 4-35	Swede Wrench	4-41
Figure 4-36	Splitter Bars	4-42
Figure 4-37	Peavey	4-42



Figure 4-38	Grapnel Hook	4-42
Figure 5-1	Padeyes	5-3
Figure 7-1	Centers of Buoyancy and Gravity	7-3
Figure 7-2	Waterline, Righting Moment Present, Ship Incline	7-4
Figure 7-3a	Vessel in Stable Condition	7-5
Figure 7-3b	Vessel in Unstable Condition	7-5
Figure 7-4	Limiting KGv Diagram	7-8
Figure 7-5	Trim Table	7-10
Figure 7-6	Change in KG Diagram	7-11
Figure 8-1	Diagram of Dredging an Anchor	8-8
Figure 8-2	Kedging the Anchor with Sternway	8-8
Figure 8-3	Kedging with the Anchor Paid Out	8-9
Figure 8-4	Tender Kedging Towards the Buoy	8-9
Figure 8-5	Side View of Flanking Rudders	8-28
Figure 8-6	Overhead View of Flanking Rudders	8-28
Figure 9-1	Hoisting Arrangement	9-8
Figure 9-2	Buoy Swinging Inboard	9-8
Figure 9-3	Centering the Buoy on the Deck	9-9
Figure 9-4	Hogging into the Stopper	9-9
Figure 9-5	Gripping Down a Buoy	9-10
Figure 9-6	Disconnecting the Mooring Chain	9-10
Figure 9-7	<b>Roller</b> Sheave and Stopper	9-13
Figure 9-8	Modeer Shackle in Mooring Chain	9-13
Figure 10-1	Hooking into the Buoy	10-7
Figure 10-2	Setting the Chain into the Chain Stopper	10-2
Figure 10-3	Breaking the Buoy	10-3
Figure 10-4	Preparing to Pull Chain	10-4
Figure 10-5	Pulling Chain	10-10
Figure 10-6	Bringing the Sinker Onboard	10-10
Figure 11-1	4 <sup>th</sup> Class Buoy (4NR)	11-5
Figure 11-2	6 <sup>th</sup> Class Buoy (6NR)	11-5
Figure 11-3	Western River Sinker	11-6
Figure 11-4	Dump Board	11-6
Figure 11-5	Wire Rope Fairlead Device	11-14
Figure 11-6	Jet Pipe Over the Side	11-14
Figure 11-7	Jet Cone Mooring on Deck	11-15
Figure 11-8	Jet Cone	11-15
Figure 11-9	Deploying Sinker with Dump Board	11-18
Figure 11-10	Pushing Buoy over the Side	11-18
Figure 11-11	10' Rohn Tower Section	11-24
Figure 11-12	Securing a Refloated Buoy	11-28
Figure 11-13	Refloated Buoy Being Recovered by Cutter	11-28
Figure 12-1	70' CG-300 Crane	12-5
Figure 12-2	60' CG-300 Crane	12-5
Figure 12-3	Hammer and Lead in Cradle	12-6
Figure 12-4	Hoisting Hammer and Lead	12-6
Figure 12-5	Crane Hoisting Pile	12-9
Figure 12-6	Cross Deck Winch Easing Out Pile	12-9
Figure 12-7	Cutting Pile Top	12-11



Figure 12-8	Cutting Pile Top	12-11
Figure 13-1	Connecting Cross Deck	13-7
Figure 13-2	Pulling Chain	13-7
Figure 13-3	Chain Pigtail	13-9
Figure 13-4	Sinker Over the Side	13-9
Figure 14-1	One Boat Wire Sweeping Diagram	14-14
Figure 14-2	Two Boats Wire Sweeping Diagram	14-15

## List of Tables

Table 4-1	Breaking Strength and WLL for common ATON Wire Rope	4-13
Table 4-2	Number of Clips Required for Various Wire Ropes	4-24
Table 4-3	Pelican Hook Sizing Chart	4-28
Table 4-4	Load Angle Stress Table	4-36
Table 14-1	One Boat Wire Sweeping Dimensions	14-14
Table 14-2	Two Boat Wire Sweeping Dimensions	14-15



## List of Acronyms

Acronym	Definition
ANB	ATON Boat (55 or 64 feet)
ANSI	American National Standards Institute
ANT	Aids to Navigation Team
ATON	Aids to Navigation
BDS	Buoy Deck Supervisor
BUSL	Buoy Boat, Utility Stern Loading
CCA	Chromated Copper Arsenate
<b>CG-LIMS</b>	<b>Coast Guard – Logistics Information Management System</b>
CO	Commanding Officer
CPP	Controllable Pitch Propeller
DIW	Dead in the Water
DPS	Dynamic Positioning System
GAR	Green, Amber, Red (Risk Assessment Tool)
IATONIS	Integrated ATON Information System
IPS	Improved Plow Steel
IWRC	Independent Wire Rope Core
LLL	Left Lang Lay
LRL	Left Regular Lay
NEM	Naval Engineering Manual (COMDTINST M9000.6(series))
NSTM	Naval Ships' Technical Manual
OIC	Officer in Charge
ORM	Operational Risk Management
PPE	Personal Protective Equipment
PQS	Personal Qualification Standard
PS	Plow Steel
RLL	Right Lang Lay
<b>SDS</b>	<b>Safety Data Sheets</b>
RRL	Right Regular Lay
SPE	Severity, Probability, Exposure (Risk Assessment Tool)
TANB	Trailerable ATON Boat
TCT	Team Coordination Training
TRLB	Temporary Lighted Buoy
TRUB	Temporary Unlighted Buoy
<b>USAIMS</b>	<b>United States Aids to Navigation Information Management System</b>
WLL	Working Load Limit
XIP	Extra Improved Plow Steel (Wire Rope), also EIPS
XXIP	Extra, Extra Improved Plow Steel (Wire Rope), also EEIPS



## GLOSSARY

<b>Term</b>	<b>Definition</b>
<b>Acetylene</b>	A colorless, highly flammable or explosive gas, C <sub>2</sub> H <sub>2</sub> , used for metal welding and cutting. When combined with compressed oxygen, it is used for heating, cutting, and welding aids to navigation components, such as cutting and connecting buoy mooring chain. These gases are stowed under pressure in special bottle-shaped steel cylinders.
<b>Adrift</b>	A floating, unmoored object moving with the prevailing wind and tide, such as a buoy broken loose from its mooring. (2) Not in proper storage; “ <i>gear adrift.</i> ”
<b>Advance</b>	Distance a vessel travels in the direction of its original course from the time the rudder is put over until it has turned through 90 degrees.
<b>Aids to Navigation (ATON)</b>	Any device external to a vessel or aircraft intended to assist a navigator to determine his position or safe course, or to warn him/her of dangers or obstructions to navigation.
<b>ATON Characteristic</b>	The audible, visual, or electronic signal displayed by an aid to navigation to assist in the identification of an aid to navigation.
<b>Aids to Navigation System, Short Range</b>	A group of interacting external reference devices intended to collectively provide sufficient and timely information with which to safely navigate within and through a waterway when used in conjunction with updated nautical charts and other commonly available material. The system includes all navigation devices within visual, audio, or radar range of the mariner. (2) Refers to the particular marking scheme used by a system of aids.
<b>Aids to Navigation Boat (ANB), Buoy Boat, Utility Stern Loading (BUSL)</b>	Specialized boats usually attached to Aids to Navigation Teams (ANT) designed for facilitating the performance of maintenance to aids to navigation, including responding to ATON discrepancies.
<b>Aids to Navigation Team (ANT)</b>	Shore-based USCG unit, whose primary mission is maintaining aids to navigation and responding to ATON discrepancies. These units are assigned a variety of boats, trucks, and other equipment to accomplish the ATON mission.



<b>Assigned Position (AP)</b>	The assigned position of an aid to navigation in latitude and longitude.
<b>Auxiliary Hoist</b>	The secondary hoist on a crane or boom. Number 2 and 3 hoist on a WLIC. A wire rope or line rove through a fixed block or sheave for hoisting. Sometimes referred to as a single whip; does not provide a mechanical advantage. A double whip is rigged with a running block, a block that moves with the load being hoisted and provides mechanical advantage. <i>Slang would be to say "Whip".</i>
<b>Avast</b>	An order to cease; stop; or hold, as in " <i>Avast heaving.</i> "
<b>Backfire</b>	When operating gas torches, a backfire occurs when the flame on a torch momentarily regresses into the torch tip and then immediately reappears or goes out completely, usually with an accompanying "pop" sound. It may be caused by the torch touching the object being heated, particles obstructing the gas flow, or the tip overheating. (2) A sustained backfire is defined as the sustained burning of the flame back inside the torch, usually at the mixer, but could also happen further upstream under certain conditions. Sustained backfires are often accompanied by a hissing or squealing sound and/or a smoky, sharp-pointed flame. (3) A <i>flashback</i> occurs when the flame regresses "upstream" of the torch's mixing chamber, which is a much more serious condition than a backfire. It is caused by the reverse flow of gases upstream into the hoses or other equipment.
<b>Bail</b>	A lifting or mooring appendage, usually permanently attached to an object designed for hoisting, griping, or mooring an object, " <i>sinker bail, buoy bail, mooring bail, etc.</i> "
<b>Barrel sling</b>	A two or more legged sling fitted with hooks designed to attach to the drum ends.
<b>Battery box</b>	A steel watertight box attached to the bell stand of a lighted buoy to house batteries. Also refers to a weather tight box, usually plastic, mounted on a lighted beacon (fixed aids to navigation).
<b>Battery pocket</b>	A steel cylinder welded in the interior of lighted steel buoys (3 1/2X8 and larger) to accommodate battery racks. These pockets are accessed via battery pocket covers, which when properly installed ensure battery pocket watertight integrity.
<b>Battery pocket vent</b>	Metal tubing fitted to the buoy packets and vented near the top of the buoy cage through a check valve.



<b>Battery rack</b>	A steel rack for holding batteries, used when a steel battery box cannot be used. It is inserted into the battery pocket of a lighted buoy.
<b>Beacon</b>	A fixed aid to navigation. Beacons are either lighted or unlighted and located on land or water. Unlighted beacons are referred to as daybeacons and lighted beacons are referred to as lighthouses, lights, or ranges.
<b>Belay</b>	To fasten a line by winding it around a cleat or belaying pin with a series of "S" turns. (2) To disregard, as in " <i>belay my last command.</i> "
<b>Belaying pin</b>	A wood or steel pin around which rigging lines are fastened.
<b>Bight</b>	A loop of line, wire rope, or chain.
<b>Bits</b>	A pair of short strong posts fixed to the deck of a vessel used to secure a line or hawser, such as a mooring or tow line.
<b>Bitter end</b>	The last part of a line, hawser, or wire rope or the last link of a chain.
<b>Block</b>	A device consisting of an outside shell and internal sheave (wheel) through which a line or wire rope may be passed. (See Chapter 4)
<b>Block and block</b>	<i>See Two-Blocked.</i>
<b>Boat hook</b>	A wood or aluminum pole with a hook attached to one end, used to fend off, hold on, or retrieve.
<b>Bollard</b>	An upright strong post on a dock or pier to which lines or hawsers may be secured.
<b>Boom</b>	A long spar projecting from the base of a mast or A-frame, used to support hoisting tackles or purchases.
<b>Bottom gripe</b>	Gripes applied to the bottom of the buoy body (hull) of a tube buoy when it is in the prone position. (See Chapter 4)
<b>Bow thruster</b>	A propeller set in a tunnel in the bow of a vessel used to steer the bow to port or starboard.
<b>Brushing</b>	Clearing vegetation that obscures or endangers a beacon (fixed aid to navigation).
<b>Bull chain</b>	A section of chain rigged fore and aft inboard of the working buoy port (the buoy port in which a buoy is to be hoisted aboard or deployed). (See Chapter 4)





<b>Bulwark</b>	Section of plating forming an extension of a vessel's side above the weather deck.
<b>Buoy</b>	A floating aid to navigation. A buoy is either lighted or unlighted and can be equipped with sound signals and radar enhancement devices.
<b>Buoy appendages</b>	Buoy mooring equipment, such as chain, bridle, shackles, swivel, etc. and sound producing equipment, such as bells, gongs, whistles, and horns.
<b>Buoy body (hull)</b>	The cylindrical section of a buoy that provides floatation. Buoy hulls are constructed of either steel or non-ferrous materials.
<b>Buoy bridle</b>	Two equal lengths of chain connected by an iron ring. The bitter ends of the two legs are attached to the buoy and ring is attached to the mooring chain through shackles and a swivel.
<b>Buoy cage (tower)</b>	The skeleton framework of a lighted or sound buoy mounted to the buoy body, which supports the radar reflector, optic, and other signal equipment.
<b>Buoy chock</b>	A wooden wedge specially shaped to fit buoy hulls.
<b>Buoy critters</b>	Mussels and other assorted marine animals found on buoys and moorings.
<b>Buoy lifting bail</b>	Lifting bail at the top of a buoy body to facilitate hoisting and griping or securing the buoy to the deck.
<b>Buoy mooring</b>	The chain, wire rope, synthetic line, or combination that connects a buoy to its sinker or anchor. In most cases the sinker or anchor as well as the attaching hardware are considered part of the buoy mooring.
<b>Buoy mooring chain</b>	A string of connected steel rings or links joined together to form a specific length. They are typically manufactured to a length of 90 feet referred to as a shot of chain. Buoy mooring chain is used to moor a buoy to the seabed.
<b>Buoy mooring eye</b>	Mooring bail on the bottom of the buoy hull to which the buoy's mooring is usually attached.
<b>Buoy pocket</b>	See Battery Pocket.
<b>Buoy port</b>	An open section in the bulwarks on each side of the buoy deck to facilitate recovering and deploying buoys.
<b>Buoy saddle</b>	Two wooden blocks connected – at a specified width – with two steel



rods and shaped to fit the contour of a buoy hull. They are designed to cradle a buoy on a horizontal surface, such as a buoy deck, dock, or truck bed.

- Buoy tender** A vessel specially designed for maintaining aids to navigation, particularly buoys and associated moorings.
- Buoy tube** A heavy gauge steel tube fitted with a counterweight attached at the other end to the bottom of some lighted buoys. The tube of a whistle buoy is hollow to accommodate a whistle or wave turbine generator.
- Cage line** A line **passed** through the cage of a buoy to steady the buoy while it's alongside a buoy tender or when being hoisted or deployed (see Chapter 4).
- Can buoy** An unlighted buoy that displays a cylindrical shape above the water line.
- Capstan** A vertical drum revolving on a spindle used to exert power required to heave around on an anchor chain, a line or hawser. Capstan drums are either smooth or provided with several raised ribs referred to as whelps.
- Cargo net** A square net of varying sizes made of natural or synthetic line, wire rope, nylon straps or chain. It is used for slinging certain cargo or may be used as a safety sling, slung between a vessels or a vessel and pier during loading operations.
- Cast** To throw, as in "*casting the lead to ascertain the water depth.*" To cause to fall, such as to turn from the wind or cause a vessel to "*fall off.*" (2) Cast off; remove lines from a dock, vessel, buoy, or other object.
- Cat's Paw** A hitch made in the bight of a line. (2) Light airs or light baffling winds which temporarily ruffle surface of the water.
- Chafe section** The section of a buoy mooring chain between the riser and bottom sections. It is in constant movement and thus typically experiences the most wear.
- Chafing gear** Additional material placed over sections of line that are prone to wear.
- Chain hook** A handled metal hook about 32 inches long used to manually move bights of chain about the deck (See Chapter 4).
- Chain sling** *See sling.*
- Chain stopper** A mechanical device used to stop off "live" chain, i.e. chain that is attached to an object outside the vessel or lead over the side.



<b>Check</b>	A line handling command meaning to keep strain on a line but slacking it as necessary to prevent the line from parting.
<b>Chock</b>	A metal deck fitting through which lines and hawsers are passed, usually to change their direction. Lines and hawsers must be threaded through a closed chock, while a bight of line can be placed in an open chock. (2) Blocks, usually wood, used to provide stability for ATON equipment and general cargo.
<b>Chromated Copper Arsenate (CCA)</b>	A chemical wood preservative containing chromium, copper and arsenic. CCA is used in pressure treated wood, such as pile, timbers, and lumber to protect it from rotting due to insects and microbial agents.
<b>Cleat</b>	An anvil-shaped deck fitting for securing or belaying lines.
<b>Come-along (Lever hoist)</b>	A hand operated ratchet lever winch. It provides mechanical advantage for moving or securing loads. Its ratchet acts as a mechanical brake that keeps the wire rope, line, or strap from unwinding.
<b>Commissioned</b>	The action of placing a previously discontinued aid to navigation back in operation.
<b>Cotter pin</b>	A split pin with two tines that are split and bent at various degrees. Primarily used aboard ATON units to keep bolts and nuts from backing off.
<b>Counterweight</b>	Weight added to the lower portion of a buoy to provide stability.
<b>Cradle</b>	A steel support permanently affixed to a vessel to place (rest) the boom, crane arm, or pile driving lead and hammer when not in use. (2) Support for a boat when stowed on deck or ashore.
<b>Crane</b>	A lifting machine powered to lift, lower, or horizontally move loads.
<b>Crane arm/boom</b>	A beam, spar, or skeletal structure projecting from the base of a crane, used to support hoisting tackles or purchases.
<b>Creosote</b>	A highly toxic wood preservative obtained from high temperature distillation of coal tar (a mixture of organic substances) and over one hundred other components. It is used to protect wood; primarily piles, timber utility poles, and railroad ties and is applied by pressure methods. It is capable of causing serious chemical burns if exposed to bare skin. Although it has been replaced with CCA in all ATON and Coast Guard construction applications, there are still old creosote piles and timbers in



use throughout the Coast Guard.

<b>Crossdeck</b>	A large line or wire rope – usually taken to power – used to provide positive horizontal control over heavy objects when they are being brought aboard, deployed, or moved aboard vessels.
<b>Cross-over tube</b>	A small tube running between the battery pockets of buoys with more than one battery pocket. The tube allows the free passage of air between the battery pockets and the outside atmosphere through the battery pocket vents. This serves to vent potentially dangerous explosive vapors from the battery pockets to the outside atmosphere.
<b>Daybeacon</b>	<i>See Beacon</i>
<b>Daylight control (DLC)</b>	A photoelectric cell that senses the amount of sunlight. It activates an electronic on/off switch in the flasher which turns the light on at dark and off during the daylight hours.
<b>Daymark</b>	Daytime characteristic of an aid to navigation.
<b>Dead In the Water (DIW)</b>	An object or vessel that is not making progress; not moving under its own power; lack of self-propulsion.
<b>Deck load</b>	General term referring to a vessel's buoy or construction deck load.
<b>Discontinue</b>	To remove from operation (temporarily or permanently) a previously authorized aid to navigation
<b>Dolphin</b>	A marine structure consisting of at least three piles driven into the seabed, usually at an angle and held together with large bolts or wire rope. Dolphins may be used as part of a dock structure or as an aid to navigation.
<b>Dredge</b>	To drag an anchor to control a vessel in current or during close-quarters maneuvering. (2) A vessel equipped with machinery for deepening channels and harbors.
<b>Drift</b>	The rate/speed at which a vessel moves due to the effects of wind, wave, current, or the accumulative effects of each. Usually expressed in knots.
<b>Drum</b>	The part of a capstan, winch, or windlass which line, hawser, or wire rope is wound. (2) A cylindrical shaped receptacle, a barrel.
<b>Dump board</b>	A wood or steel platform used as a lever with the fulcrum positioned on the outboard end used to set small sinkers, usually up to 500 pounds. Fixed dump boards are located on some vessels that are capable of



handling 1500 pound sinkers. Sometimes referred to as a teeter board.

<b>Dunnage</b>	Lumber or other material used to protect cargo in the hold of a ship as well as the ship's cargo hold; planks placed on deck to add friction between the flat surface of an object and a steel deck.
<b>Ease</b>	To reduce the amount of applied rudder by a certain amount, or in the absence of an amount, to reduce it by half. <b>(2)</b> To reduce the speed of a vessel. <b>(3)</b> To reduce the tension on a line or hawser.
<b>End fitting</b>	The termination fitting at the end of a wire rope, such as a " <i>poured fitting, pressed fitting, etc.</i> "
<b>End for end</b>	To reverse something to facilitate even wearing, generally referring to buoy mooring chain or wire rope rigging – neither practice is recommended.
<b>Extinguished</b>	A lighted aid to navigation which fails to show its advertised light characteristic.
<b>Fairlead</b>	A point, usually a specialized fitting, such as a block, chock, or roller used to change the direction and increase effectiveness of a line or cable.
<b>Fake</b>	To lay out a line, hawser, or chain in long flat bights that will pay out freely without fouling.
<b>Fathom</b>	A unit of measurement that equals 6 feet.
<b>Fender</b>	A device constructed of wood, line, synthetic foam, rubber, or plastic rigged on a vessel, dock, or pier to absorb the shock and reduce chafing effects of contact between vessels or between a vessel and pier.
<b>Fiege fitting</b>	A three-piece wire rope end-fitting consisting of a sleeve, a plug and a covering socket. (See Chapter 4 )
<b>Fishhook</b>	The end of an individual broken wire that protrudes from the surface of a wire rope.
<b>Fix</b>	A geographical position determined by measuring the angle, bearing, or distance of established terrestrial references or electronic positioning data received from a global satellite system.
<b>Fixity</b>	When a pile penetrates the seabed to a depth where the pile will be adequately supported by the surrounding soil enabling it to resist applied overloading lateral forces to the point of structure failure (see Soil failure).



<b>Flashback</b>	<i>See Backfire</i>
<b>Flasher</b>	An electronic device that regulates the flash duration of a light.
<b>Flat bottom buoy</b>	A lighted buoy with a flat bottom that allows it to sit upright on a flat surface.
<b>Foul</b>	To entangle, confuse, knot, or obstruct. Jammed, knotted, or entangled; not clear for running referring to line, hawsers, wire rope, or chain.
<b>Grapnel hook</b>	A device used to drag the seafloor to recover sunken objects such as buoys. Grapnel hooks come in various sizes and weights and consist of from three to five hooks (claws, flukes).
<b>Gripe</b>	To secure an object using gripes, such as “ <i>gripe the buoy</i> ”. (2) Chain, synthetic web material, line, or wire rope used with ratcheting devices to secure objects in place. (See Chapter 4)
<b>Ground tackle</b>	Anchors, cables, chain, windlass, capstan and all associated gear used in dropping or heaving in anchors and securing a vessel at anchor.
<b>Gypsy head</b>	A small auxiliary drum at the end of a windlass. Used to apply power to lines and hawsers.
<b>Guy/Vang</b>	A line, wire rope or chain used to steady a mast, boom, or gaff; can be part of running or standing rigging. (See vang)
<b>Hand-over-hand</b>	Hauling chain using two purchases, not a recommended method of retrieving buoy or anchor chain. (2) Hauling in a line or hawser by personnel passing their hands alternately one before the other.
<b>Happy hooker</b>	<i>Slang.</i> A mechanical line reeving device used to thread a hook, <b>sling or line through a bail or lifting point</b> of an object outside a vessel, such as a buoy.
<b>Hatch</b>	An opening in a vessel’s deck affording access to lower compartments.
<b>Hatch cover</b>	A watertight covering for a hatch.
<b>Hawser</b>	A large fiber or synthetic line with a circumference of 5 inches or more, typically used for mooring or tow lines.
<b>Head block</b>	A large wood block, typically a section of a 12”x12” timber, used to support the upper buoy body of a lighted tube buoy (a buoy with its counterweight at the end of a buoy tube) when it is the prone position. (See Chapter 4)



<b>Head gripe</b>	<i>Slang. See "Top Gripe."</i>
<b>Heat and beat</b>	To join two section of chain together. (2) A rivet pin chain shackle used to join two section of buoy chain.
<b>Heat and beat anvil</b>	A steel device used to steady a heat and beat shackle and chain during the heat and beat process, i.e. heating the pin and striking it with large hammers or sledgehammers. Heat and beat anvils may be mounted on a head block to bring it off the deck for more efficiency. The most efficient design is shown in figure 4-34, where the anvil is supported with four strong pipes welded to a bottom plate.
<b>Heave around</b>	To take in line, hawser, chain, or wire rope; manually or by taking to power with a gypsy head, capstan, winch, capstan, etc.
<b>Hitch</b>	Securing a line to a hook ring or spar. There are various types of hitches, such as a clove hitch, rolling hitch, timber hitch , etc.
<b>Hog/Hogging stress</b>	The condition of a vessel in which the bow and stern have drooped; when the midship section of a vessel is supported by a wave crest and the bow and stern are poised over a trough.
<b>Hogging chain</b>	The act of using a line or wire rope to haul buoy chain into a mechanical chain stopper. (2) A shot of buoy chain run under a seagoing buoy tender and secured on deck at either side. Used for transferring a mooring from one side of the vessel to the other when relieving buoys or when setting extraordinary heavy moorings for larger buoys on West Coast bars, such as the Columbia River.
<b>Hogging line</b>	A line or wire rope taken to power to haul buoy chain into a mechanical or hydraulic chain stopper.
<b>Hoist</b>	To rise up or lift with a line, wire rope, or other rigging gear, usually taken to power or rigged for mechanical advantage, such as a block and tackle.
<b>Horse collar</b>	A semi-circle shaped steel device mounted to a chain stopper to keep buoy chain in the chain stopper during chain retrieval operations.
<b>Hot pack</b>	A portable system of temporary batteries attached to a lighted buoy to provide emergency power to the light system when the primary power system has failed. With the advent of solarization, external buoy battery boxes, Light Emitting Diode (LED) lanterns, hot packs are rarely necessary.



<b>Inboard</b>	Toward the fore-and-aft centerline of the ship; inside the deck edge or shell plating, as opposed to outboard.
<b>Jet cones</b>	Conical steel plates with an opening at the apex used to moor river buoys to the riverbed. They are jetted into the river bed with high pressure water hoses and pipes.
<b>Jetting</b>	The use of high pressure water to displace river/seabed soil to facilitate inserting piles or other anchoring/mooring appendages.
<b>Jetty</b>	A structure usually constructed in pairs with rock or concrete built from shore to extend an inlet into deeper water, and/or protect a river mouth or harbor entrance from storms and shoaling and/or direct the flow of current.
<b>Kedging</b>	To move a vessel by hauling in on a line, chain, or wire rope fastened to an anchor that has been dropped some distance from the vessel.
<b>Keel haul</b>	To drag an object under a vessel's keel from one side of the vessel to the other, such as to " <i>keel haul a buoy.</i> "
<b>Kingpost</b>	Post supporting a boom on a vessel; the upright that supports the boom of some cranes.
<b>Kink</b>	A tight curl, twist, or bend caused by a doubling or winding of something about itself such as line, wire rope, chain, or hose.
<b>Lamp</b>	An incandescent light bulb used in lighted aids to navigation.
<b>Lamp changer</b>	A mechanical device that replaces an inoperable lamp by rotating an operating lamp into the lantern's focal plane.
<b>Lattice boom</b>	A skeletal boom extending projecting from the base of a crane, used to support hoisting tackles or purchases. Lattice boom cranes are used aboard USCG Inland Construction Tenders (WLIC).
<b>Lay/Lay length</b>	<i>See Chapter 4</i>
<b>Lead line</b>	A line with unique markings used to determine water depth weighted on one end with a lead weight. The markings on a standard lead line are attached to the line at various lengths to indicate the water depth in fathoms. Lead lines can also be used to help determine the type of bottom by adding tallow or soap to the cavity in the bottom of the lead – "arming the lead."
<b>Lifeline</b>	A line, chain, or wire rope rigged on vessel weather deck stanchions for





personnel safety.

<b>Line</b>	Term for fiber or synthetic rope greater than 1-1/2 inches in circumference but less than 5 inches in circumference.
<b>Live chain</b>	Chain that is attached to an object outside the vessel or led over the vessel's side; chain that has the possibility of running, i.e. freely paying out usually over the side.
<b>LWP (Left Watching Properly)</b>	An aid to navigation is exhibiting the proper characteristics, including position, as defined in the appropriate USCG Light List. Used to reflect the status of an ATON after a service delivery unit has performed maintenance; when a previously discrepant ATON is restored to a condition so that it exhibits its proper characteristics.
<b>Main Hoist</b>	When used in rigging, refers to the weight handling purchase on the crane or boom with the greatest lift capacity, usually a multiple purchase.
<b>Major light</b>	(1) Operational – The nominal range of a beacon is 10 nautical miles or greater. (2) Structure – A beacon of relatively complex construction, such as mono-pile or ice-resistant structures built in deep water (greater than 25 feet) on shore whose overall height usually exceeds 75 feet.
<b>Marker buoy</b>	A small float anchored to the seabed used to temporarily mark a location on the water.
<b>Marlinspike</b>	A multipurpose pointed steel tool used to separate the strands of wire rope when splicing, to loosen screw pins, removing shackle split keys, applying seizings, etc.
<b>Marry</b>	To join together, such as two ropes joined in a seizing.
<b>Mechanical advantage</b>	The ratio of output force working on a load produced by a machine to the input force, such as the advantage gained by using a multiple purchase.
<b>Messenger</b>	A smaller line attached to the eye of a hawser to facilitate passing the hawser to a vessel or pier.
<b>Minor light</b>	(1) Operational – The nominal range of a beacon is less than 10 nautical miles. (2) Structure – A beacon of relatively simple construction, such as single or multiple pile structures built in shallow water or on shore whose overall height usually doesn't exceed 75 feet.
<b>Modeer shackle</b>	A narrow elongated shackle with a removable keyed pin specially



designed for handling mooring chain. (See Chapter 4)

**Mouse/Mousing**

A small collar made of small stuff, line, or wire with the purpose of holding something in place. (2) A collar placed over the hook jaw to prevent a load from “unhooking” – can be applied by passing two or three turns of line, small stuff, or wire across the hook jaw; a spring loaded mechanical latch.

**SDS (Safety Data Sheet)**

A form containing data regarding a particular substance; intended to provide personnel, including emergency personnel, with procedures for handling or using a particular substance in a safe manner. It includes information such as the substance’s physical data (melting point, boiling point, flash point, etc.), toxicity, health effects, first aid, reactivity, storage, disposal, protective equipment, and spill-handling procedures. (*Formerly MSDS – Material Safety Data Sheets*)

**Nipper chain**

A section of rigging chain fitted with rings on both ends. It is used to recover chain or other objects by passing the chain around the object, slipping one ring through the other, and cinching the nipper chain around the object.

**Nub**

*Slang for A portion of a pile protruding from the seabed.*

**Nun buoy**

An unlighted buoy displaying a conical shape above the water line

**Off station**

A buoy that is not on its assigned position and has not been temporarily relocated.

**Outage**

*Slang for Extinguished; a lighted aid to navigation that has failed to operate as advertised.*

**Outboard**

Outside of a vessel's hull; away from the center or keel line, the opposite of inboard.

**Overriding turns**

Turns placed over existing turns on a capstan or winch.

**Oxy-Acetylene torch**

A torch that mixes specific amounts of acetylene with oxygen producing an intense flame. Uses include cutting chain, steel piles, buoys and structure parts, heating rivet pins, and welding.

**Padeye**

A steel eye, often with a link attached, affixed to a vessel to accommodate securing cargo or other objects, such as buoys, and to facilitate temporary or permanent rigging arrangements.

**Pallet**

A portable platform usually constructed of wood, used for cargo handling operations.



<b>Pawl</b>	A steel hinged lever that prevents backward movement of line, wire rope, webbing, or chain under tension, such as a “ <i>riding pawl.</i> ”
<b>Pear link</b>	An oblong metal link narrow at one end and wide at the other, attached to the end of a sling or pendant.
<b>Pelican hook</b>	A hinged hook fitted with a sliding ring to facilitate releasing; used to stop off buoy mooring or anchor chain.
<b>Pendant</b>	A length of wire rope, synthetic material, or chain fitted with an oval or pear link on one end and a hook on the other end; also referred to as a picking pendant.
<b>Pigtail</b>	The section of mooring from the bitter end to where the mooring chain is attached to the sinker bail, typically 3 to 5 links. The pigtail is used to hang a sinker in a chain stopper.
<b>Pile</b>	A heavy beam of timber, concrete, or steel, driven into the seabed as a foundation or support for an ATON beacon/structure.
<b>Plumb (a hatch)</b>	To rig a tackle directly over a hatch opening.
<b>Point load</b>	Occurs when a load is not centered on the hook but rests near the point (end) of the hook.
<b>Poured socket</b>	A closed socket end fitting affixed to the end of wire rope by pouring resin or hot zinc. Poured sockets are sometimes referred to as spelter sockets.
<b>Preventer</b>	(1) A purchase of a crane or boom rigged to prevent the boom from snapping back should a sudden shift in weight or hoisting purchase failure occur during hoisting operations. (2) A length of chain used to secure a river buoy to the deck during buoy retrieval operations on the Western Rivers.
<b>Primary battery</b>	A type of battery which cannot be recharged.
<b>Punt</b>	Rectangular shallow boat used on many smaller tenders and during flood relief operations.
<b>Purchase</b>	A device, such as a winch or block and tackle used to obtain mechanical advantage, such as the “Main Purchase” in a crane or boom. A purchase can be rigged with multiple blocks or as a single line.
<b>Radar reflector</b>	Flat pieces of radar reflective material placed on or built into an object to make it more radar reflective than it would be ordinarily. Certain



unlighted and most all lighted aids have these.

<b>Ratchet load binder</b>	Turnbuckle style ratchet binder consisting of a barrel with two opposite threaded rods each fitted with a hook or other type of rigging gear on the end. A ratchet mechanism is attached to the barrel center which is operated by a handle which retracts or extends the threaded rods to apply or release tension on a gripe down system. Also known as a "Steamboat Jack." There are pneumatic versions available.
<b>Ratchet tie down straps</b>	A tie down device consisting of a synthetic strap (available in a variety of widths and lengths) and ratchet mechanism to apply and release tension.
<b>Ready for riding</b>	To place chain in a pelican hook in preparation to place the chain under strain, such as when attempting to free a sinker from the seabed.
<b>Recharged</b>	Replacing the batteries in a lighted aid to navigation or an aid that otherwise requires power.
<b>Recovered</b>	An aid to navigation that has been retrieved after being reported adrift, aground, missing, sunk, or destroyed.
<b>Reeve</b>	To pass a line, wire rope, hawser, or hook through a hole, ring, pulley, or block.
<b>Reeving line</b>	A line attached at one end to a line reeving device, such as a "Happy hooker", with the other end attached to the tip of a hook. Used primarily for reeving a hook in a buoy bail.
<b>Refusal</b>	When a pile has been driven to the point where 20 blows from a diesel hammer fails to drive the pile more than an average of 1/8 inch per blow.
<b>Retroreflective tape</b>	Specially constructed adhesive tape that reflects light back along the same path that it first contacted the material, which is different from a mirror's reflective properties that reflect light off at a different angle. Used for numbers and borders on buoys and dayboards.
<b>Relieved</b>	Replacement of an aid to navigation, typically a buoy, with an aid of similar type and characteristic.
<b>Relighted</b>	To return an extinguished aid to navigation to its advertised characteristic.
<b>Relocated</b>	Authorized relocation of an aid to navigation from its previous assigned position.



<b>Reset</b>	A buoy returned to its assigned position after being reported off station, adrift or missing.
<b>Riding pawl</b>	A safety stopper designed to stop anchor chain from running when anchored, weighing anchor, or securing the anchor for sea. It is lifted up to the "open" position when the anchor chain is run out. Sometimes referred to as a "cat's paw."
<b>Rigging</b>	A system of lines, wire rope, and other gear used to support masts and booms, referred as standing rigging. Rigging designed to move is referred to as running rigging, such as weight handling booms, cranes, and associated gear.
<b>Rivet-pin shackle</b>	A chain shackle used join sections of buoy chain. The pin is heated with a special oxy-acetylene torch and peened to keep it in place. (See "Heat and Beat")
<b>Roller chocks</b>	A fairlead chock fitted with rollers to reduce the friction on lines, hawsers, and wire rope.
<b>Rotten stop</b>	Small line, usually ¼" fiber line (6-thread) used to lash bights of mooring chain or towing line intended to check chain or hawser payout speed.
<b>Saddle</b>	<i>See Buoy saddle.</i>
<b>Safe Working Load (SWL)</b>	An outdated term. Use Working Load Limit (WLL) instead.
<b>Safety chain or Safety device</b>	A chain, lifeline, or safety net rigged to span the buoy port opening. It is "dropped" (removed) during certain buoy deck operations.
<b>Safety shackle</b>	Either a chain or anchor type shackle that uses a bolt pin, (i.e. a bolt capped with a nut on one end), which employs a cotter pin to keep the nut from backing off.
<b>Sagging</b>	The condition of a vessel in which the bow and stern are supported by succeeding wave crests and the midship section is poised over a trough.
<b>Screw pin shackle</b>	A shackle where one of the openings is threaded to accept a threaded tip pin.
<b>Secure</b>	(1) To cease or stop doing something, such as " <i>secure the fire main.</i> " (2) To fix in place; to make ready for sea so that the movement of a vessel upon the sea will not upset cargo, objects, or other gear.
<b>Seizing</b>	To wrap with small stuff or wire, as one line to another or a line to



another object.

<b>Set</b>	(1) The direction toward which a vessel or floating object is moving – measured in degrees (usually true versus relative). (2) An order to deploy something, such as “ <i>set the buoy.</i> ”
<b>Sheave</b>	The wheel in a block on which a line, wire rope or hawser rides; a pulley.
<b>“Shoot the tube”</b>	To enter the hollow counterweight tube of a whistle buoy to remove (scrape) "buoy critters" (small marine organisms) from inside the tube.
<b>Shot</b>	A standard section of chain that equals 90 feet or 15 fathoms.
<b>Side-load</b>	When a horizontal force is applied to a crane or boom, such as dragging a load sideways instead of positioning the hoisting purchase directly over a load.
<b>Sinker</b>	A buoy anchor constructed of concrete or cast iron varying in weight. Concrete sinkers are occasionally referred to as “rocks.”
<b>Skeleton tower</b>	A steel tower made up of vertical, horizontal, and diagonal components. They are either square or tapered.
<b>Slack</b>	To release tension on a line, wire rope, or hawser without losing control.
<b>Sling</b>	A single or multiple legged device used to hoist loads. Slings are typically constructed of wire, synthetic, or fiber rope, or chain. One end of a sling leg is typically fitted with a transition link which is attached to a hoisting device (crane or boom hook) or a master link in the case of multiple legged slings. The other leg end(s) is fitted with a transition link connected to a rigging apparatus, such as a hook, shackle, etc.
<b>Slushing</b>	The application of specialized lubricant on wire rope. This lubricant should be applied with a pressure lubrication system equipped with scraper plates designed to remove old lubricant and dirt. Care should be taken to avoid solvent cleaners as the solvent may remain in the rope’s core, allowing corrosion and shortening the rope’s service life..
<b>Small stuff</b>	Term for fiber or synthetic rope less than 1-1/2 inches in circumference.
<b>Snap hook</b>	A hook moused by a spring loaded latch.
<b>Snatch block</b>	A single-sheaved block with a hinged strap that can be opened to accept the bight of a line or wire rope.



<b>Soil failure</b>	Occurs when the seabed soil around a pile is not strong enough to adequately resist overloading lateral forces causing the pile to lean.
<b>Solar panel</b>	A panel of photovoltaic cells used on lighted aids to navigation to convert sunlight to electricity that recharges solar batteries. These batteries provide the power required for the aid's light and other electrical equipment.
<b>Soundings</b>	Water depth readings.
<b>Spelter Socket</b>	<i>See Poured Socket.</i>
<b>Split key shackle</b>	A chain shackle whose pin is secured by a spreading the tines of a flat split key rove through the end of the pin. Split key shackles come in a variety of sizes and are widely used in the aids to navigation maintenance for connecting chain, bridles, and swivels and other mooring appendages to buoys and sinkers.
<b>Spot</b>	To position a boom to facilitate the proper reeving of a hook into an object to be hoisted.
<b>Spuds</b>	Long vertical metal or metal-framed wooden timbers that are hoisted and lowered in through spud wells by means of a winch, boom, or crane. Used to firmly hold a vessel or barge in place during ATON or other weight handling operations.
<b>Stability</b>	The measure of a ship's ability to return to its original position when it is disturbed by a force and the force is removed.
<b>Stand by</b>	The order to wait at the ready; i.e. to be ready to execute the next order quickly.
<b>Station keep</b>	To keep a vessel within a certain distance of a given location on the water.
<b>Steamboat jacks</b>	<i>See Ratchet load binder</i>
<b>Steerageway</b>	A rate of headway sufficient to make a vessel answer its helm.
<b>Stow</b>	To place or arrange gear in its proper place. <b>(2)</b> To fill by packing tightly
<b>Strain</b>	Under heavy tension; to sustain heavy and varied stresses, as in “ <i>a vessel straining at its moorings in a storm.</i> ”
<b>Strike</b>	<b>(1)</b> To take down, as in “ <i>strike the wind pennant.</i> ” <b>(2)</b> Engage in



intense training to prepare an enlisted person for a technical rating.

<b>Structure failure</b>	Occurs when overloading lateral forces cause a structure's foundation to fail, such as a pile breaking or bending.
<b>Surge</b>	To allow a line or hawser to slip around a windlass; sudden slipping of a line or hawser under tension. <b>(2)</b> Onward motion of, or caused by, a swell or wave. <b>(3)</b> Increased activity, as in " <i>surge operations.</i> "
<b>Swing arms</b>	A pair of steel arms that ride on steel pins that are welded perpendicular to the hull of flat bottom lighted buoys directly opposite each other. Swing arms extend down towards the buoy's counterweight, provide connecting points for a buoy bridle, and pivot around the pins to compensate for the buoy's movement in a seaway.
<b>Swingbolt</b>	Stainless steel bolts that pivot on pins welded to a buoy battery pocket used to secure the pocket cover ensuring a watertight seal.
<b>Swivel</b>	A fitting that consists of two separate fitting joined so as to allow each fitting to turn independently of each other. Used in buoy moorings, anchor ground tackle, and weight handling gear.
<b>Tackle</b>	A purchase or set blocks rove with line, wire rope, or chain for obtaining a mechanical advantage for hoisting or pulling.
<b>Tag line</b>	A line used to steady a load being hoisted and moved with weight handling gear.
<b>Tension</b>	Placing strain on line, hawser, wire rope, or chain to remove all slack; to tighten.
<b>Tensor</b>	Similar to a steamboat gripe in function, a tensor is an industrial tool to secure loads on deck or cargo hold. Features a screw-type action with eccentric loading. While turning the drive head with a impact wrench, ratchet, or breaker bar, the large outer barrel telescopes over the inner barrel and pulls the anchoring points together.
<b>Tongs</b>	Any of various implements consisting of two arms hinged, pivoted, or otherwise fastened together, for seizing, holding, or lifting something
<b>Top Gripe</b>	Gripes applied to the top head of a tube buoy body when it is in the prone position. (See Chapter 4)
<b>Topping lift</b>	Multiple purchase rigged to support, hoist, and lower a boom.
<b>Transfer</b>	The distance a vessel travels right or left of its original course from the time the rudder has been put over until it has swung 90 degrees from its





original course.

<b>Tripping line</b>	A line secured to an eye on the back of a lifting hook for controlling and clearing it from a lifting bail.
<b>Tube buoy</b>	A lighted buoy with a counterweight tube affixed to the buoy bottom head. It rests in the prone position on flat surfaces.
<b>Two-block</b>	When a tackle has reached the limit of its hoist and the upper and lower blocks meet each other. Sometime referred to as "Chock-a-block".
<b>Up-and-down</b>	Buoy mooring or vessel anchor chain leading overboard is perpendicular to the sea surface, i.e. it tends neither forward, aft, inboard nor outboard.
<b>Up behind</b>	The command to remove the strain off a line or hawser, remove it from a capstan, windlass, cleat, or bitts, and allow it to go completely slack.
<b>V-band</b>	A stainless steel clamping devise used to seal a lid to its container providing a watertight seal. V-bands are found on some aid to navigation lanterns.
<b>Vangs</b>	Multiple purchases leading from each side of the boom to attachment points on the port and starboard side of a vessel. Vangs are usually powered by mechanical winches and control the lateral movement of a boom. On some booms, vangs are rigged to provide horizontal control of the boom in addition to lateral control.
<b>Vent valves</b>	A specialized version of a check valve, they are designed to seal the vent lines on lighted buoys if it heels over more than 30 degrees or submerges.
<b>Weather hitch</b>	A knot used to secure a line after belaying. A bight is twisted on top of itself and cinched down.
<b>Whelp</b>	One of the projecting ribs fitted on the periphery of a capstan barrel or gypsy head to give better grip to the line. Also, one of the sprockets on the wildcats of a windlass which engages the links of the chain cable.
<b>Whip</b>	<i>Slang for Auxiliary Hoist.</i>
<b>Winch</b>	Machine used for hoisting or heaving.
<b>Wire rope</b>	Rope consisting of steel wires twisted together forming strands, which are laid helically around a core constructed of fiber material (natural or synthetic) or steel.



**Wire rope clip**

Mechanical means of securing wire rope together consisting of a U-bolt, roddle (saddle) and nuts.

**Working load limit (WLL)**

A rating for weight handling gear that describes the operational load limits when uniformly applied in a straight pull. Working load limits are permanently affixed to weight handling gear.



# Chapter 1

## Introduction

---

### Introduction

The purpose of this manual is to provide Aids to Navigation (ATON) personnel with the safest, most efficient methods and practices of good seamanship possible to better manage the risks inherent in ATON operations. Specialized ATON seamanship plays a critical role in achieving this purpose both afloat and ashore. While local conditions may require slight variations in certain methods and practices, these variations should never compromise the basic principles of safety and good seamanship.

---

This chapter contains the following sections:

Section	Topic	See Page
A	Warnings, Cautions, Notes	1-3
B	ATON Manual Volumes	1-5
C	Changes	1-7
D	Action	1-9



This page left intentionally blank



## Section A. Warnings, Cautions, Notes, and Procedures

**Introduction**      The following definitions apply to Warnings, Cautions, and Notes found throughout the handbook.

### A.1. Warning

**WARNING** 

A “Warning” is an operating procedure or technique that must be carefully followed to avoid personal injury or loss of life.

### A.2. Caution

**CAUTION !**

A “Caution” note is an operating procedure or technique that must be carefully followed to avoid equipment damage.

### A.3. Note

**NOTE** 

A “Note” is an operating procedure or technique essential to emphasize.

### A.4. Non-Mandatory Procedures

Throughout this manual there will be mandatory procedures as well as suggested recommended best practices. Mandatory procedure or policy will be so indicated with the preceding words “will” or “shall.” Refer to the Aids to Navigation Manual - Administration, COMDTINST M16500.7 (series) for more specific information concerning Coast Guard's aids to navigation administrative policies and other operating procedures.



This page left intentionally blank



## Section B. ATON Manual Volumes

---

### **ATON Manual Volumes**

The Aids to Navigation Manual is published in six separate volumes.

1. Aids to Navigation Manual – Positioning, COMDTINST M16500.1 (series), prepared and revised by Commandant (CG-~~553154131~~)
  2. Aids to Navigation Manual – Technical, COMDTINST M16500.3 (series), prepared and revised by Commandant (CG-432)
  3. Aids to Navigation Manual – Administration, COMDTINST M16500.7 (series), prepared and revised by Commandant (CG-5531)
  4. Aids to Navigation Manual – Radionavigation, COMDTINST M16500.13 (series), prepared and revised by Commandant (CG-5532)
  5. Aids to Navigation Manual – Seamanship, COMDTINST M16500.21 (series), prepared and revised by Commandant (CG-751)
  6. Aids to Navigation Manual – Structures, COMDTINST M16500.25 (series), prepared and revised by Commandant (CG-432)
-



This page left intentionally blank





## Section C. Changes

---

### **Introduction**

Commandant (CG-751) promulgates this manual and its changes. Submit recommendations for changes to CG-751 via standard memo or electronic mail. For more information, contact CG-751, the ATON Seamanship subject matter expert (SME) at (202) 372-2518.

The address for CG-751 is:

Commandant (CG-751)  
U.S. Coast Guard Headquarters  
2100 Second Street SW, Stop 7357  
Washington, DC 20593-7357

Attn: ATON Seamanship SME

---



This page left intentionally blank



## Section D. Action

**Introduction**      Operating and supervisory commands and boat crews conducting the ATON mission will comply with the procedures and limitations specified in this publication and any duly issued changes.

**D.1. Configuration Control**      Configuration control for the ATON fleet is critical. Unauthorized changes to buoy deck equipment are strictly prohibited and may result in severe or catastrophic injury to equipment and/or personnel. Submit proposed changes via the Time Compliant Technical Order (TCTO) process through the appropriate Product Line Manager (PLM).

**NOTE** *↪*

To maintain fleet-wide standardization, unit commanders shall not change or vary the type equipment carried except where noted. Design or structural alterations are prohibited unless specifically authorized by the Surface Forces Logistics Center (SFLC).

**NOTE** *↪*

Prototype testing of any installed ATON gear (i.e. different wire rope on the cross-decks) may only be carried out with the specific authorization of the SFLC.



This page intentionally left blank.



## Chapter 2

# Training and Certification

---

**Introduction** This chapter will cover the requirements to train and certify in the various positions on a buoy or construction deck. It will clarify the requirements and the progression of events for certification and re-certification.

The training and certification requirements set for in the Boat Operations and Training Manual, COMDTINST M16114.32 (series), shall take precedence over this chapter with regards to small boat training and certification requirements for boats operated by ATON units.

---

This chapter contains the following sections:

<b>Section</b>	<b>Topic</b>	<b>See Page</b>
A	Progression of Certification	2-3
B	Training Guides	2-5



This page left intentionally blank



## Section A. Progression of Certification

---

<b>Introduction</b>	This section covers the progression of certification for members employed on the buoy or construction deck.
<b>A.1 Buoy Deck Progression</b>	<p>The basic progression for certification in buoy deck positions is as follows. The order of these positions may be modified at a command's discretion.</p> <ol style="list-style-type: none"> <li>a. Rigger</li> <li>b. Crane Operator</li> <li>c. Buoy Deck Supervisor</li> <li>d. Safety Supervisor</li> </ol>
<b>A.2 Construction Deck Progression</b>	<p>The basic progression for certification in construction deck positions is as follows. The order of these positions may be modified at a command's discretion.</p> <ol style="list-style-type: none"> <li>a. Rigger</li> <li>b. Crane Operator</li> <li>c. Construction Deck Supervisor</li> <li>d. Safety Supervisor</li> </ol>
<b>A.3 Initial Certification</b>	Personnel seeking initial certification on a buoy or construction deck shall follow the progression listed in paragraphs A.1 or A.2 of this section, as applicable.
<b>A.4 Same Class Follow-on Tours</b>	<p>Personnel re-assigned to a cutter of the same class do not need to recertify through all positions in the progression. Subject to command requirements, personnel completing follow-on tours aboard the same cutter class shall only be required to recertify to the highest level achieved at the last unit and any new certifications they are required to obtain.</p> <p>For example, if a BM1 reports aboard a 175' WLM and the member was previously a Rigger and BDS on another 175', BM1 need only recertify as a BDS but must complete all initial qualification requirements for certification as a Safety Observer, if required by the command.</p>



### **A.5 Previously Certified on Different Classes**

Personnel that are serving on different a class of cutter than they have previously served shall start with the lowest possible certification (Rigger) and work up to achieve the command's expectations.

For example, if an MK3 was a Crane Operator on a 160' WLIC and receives orders as an MK1 onboard a 75' WLIC, the MK1 must certify as a rigger to begin his progression to crane operator.

---





## Section B. Training Guides

---

### Introduction

This section covers the different types of guides available to individuals seeking certification. These guides include Watch Qualification Standard (WQS), Personnel Qualification Standard (PQS), and Job Qualification Requirements (JQR).

---

### B.1 Guide Hierarchy

The hierarchy of qualification guides is as follows; WQS, PQS, and JQR. Descriptions of each of these guides, and their contents, taken from the Cutter Training and Qualification Manual, COMDTINST M3502.4 (series), are below:

1. WQS has been developed to standardize, simplify and expedite the existing watchstation qualification process. WQS is the standard system for certification onboard the 175', 225', 240' cutter classes and it may be supplemented with locally produced JQRs. WQS guides cover engineering watches, damage control positions, underway bridge watches and inport watches.
  2. PQS is a qualification system wherein completion to a minimum level of competency is required prior to qualifying to perform a specific watchstation. A PQS is a compilation of the minimum knowledge and skills that an individual must demonstrate in order to qualify to stand watches or perform other specific routine duties necessary for the safety, security or proper operation of the unit. The goal of PQS is to standardize and facilitate these qualifications.
  3. Locally produced PQS type manuals are called Job Qualification Requirements to distinguish them from formally promulgated PQS. JQRs shall be produced when no existing PQS covers a specific watchstation.
- 

### B.2 ATON Related PQS

The following Commandant Instructions are the authorized PQSs for the appropriate cutter class, unless an approved WQS is in place:

- a. Personnel Qualification System (PQS) – Buoy Deck Operations, COMDTINST M3502.12 (series)
  - b. Personnel Qualification System (PQS) – River Tender Operations, COMDTINST M3502.13 (series)
  - c. Personnel Qualification System (PQS) – Construction Tender Operations, COMDTINST M3502.14 (series)
-



**B.3 ATON  
Courses**

---

The Aids to Navigation Manual – Administration, COMDTINST M16500.7 (series) contains a list of ATON related courses offered by NATON that may be available for training crews and individuals.

---



## Chapter 3

# Personal Protective Equipment (PPE), Protective Clothing and Safety Procedures

---

**Introduction** The Aids to Navigation (ATON) mission is inherently dangerous and personnel safety is paramount. The use of weight handling equipment to move heavy objects on a moving platform, often in adverse weather conditions, require personnel to be outfitted in protective clothing that allows them to work comfortably while ensuring their personal safety. By utilizing the proper Personnel Protective Equipment (PPE), wearing the appropriate protective clothing and understanding basic safety procedures, personnel can safely execute the ATON mission.

---

**In this chapter** This chapter contains the following sections:

Section	Topic	See Page
A	Personnel Protective Equipment and Protective Clothing	3-3
B	Operational Risk Management and Safety Procedures	3-9
C	Pressure Treated Piles	3-13
D	Diving Operations	3-15

---



This page intentionally left blank



## Section A. ATON Crew Protective Clothing and Equipment

**Introduction** There are several different pieces of ATON Crew Protective Clothing and Equipment required during ATON operations. Each piece is designed to protect the wearer from environmental conditions and hazards that are common in this line of work.

**NOTE** 

**Some articles of ATON Crew Protective Clothing and Equipment worn by members who work ATON on cutters and shore units is considered organizational clothing in the Coast Guard Uniform Regulations, COMDTINST M1020.6 (series).**

**A.1. ATON Crew Protective Clothing** All crew members involved in Aids to Navigation Operations, including observers and/or passengers exposed to the buoy deck, shall use protective clothing as follows:

**A.1.a Issuance** The following items shall be issued to personnel who routinely work ATON as a crewmember on a cutter or an ATON team (ANT). Units may have to purchase different styles depending on operations/purpose and geographic location of unit (climate).

- |   |                            |
|---|----------------------------|
| (1) Gloves                                | (2) Safety footwear        |
| (3) Coveralls                             | (4) Rain Gear              |
| (5) Personal Flotation Device (PFD)       | (6) Hardhat                |
| (7) Safety Glasses/Goggles (Clear/Tinted) | (8) Knife (see below note) |

**NOTE** 

**ATON units often exercise the option to remove the boat crew survival vest with its attached survival knife during ATON operations. If this is done it is recommended that deck personnel be issued two knives: one for routine use on deck, and the other to be used in the event of an emergency on deck. The emergency knife should have a fixed, serrated blade and be affixed to the Type III working PFD in a readily available position to decrease response time.**



**A.1.b. Cold Weather Issuance**

Those units that operate in the Cold Weather Environment described in the Rescue and Survival Systems Manual, COMDTINST M10470.10(series) are also authorized to issue the below listed items as needed:

- (1) Insulated Coveralls
- (2) Hardhat Liner
- (3) Long Underwear
- (4) Thermal Socks
- (5) Insulated Gloves
- (6) Insulated Safety footwear

**NOTE** 

**Issued PPE / protective clothing shall meet the minimum standards (if applicable) listed in this chapter.**

**A.1.c Procurement**

Procurement of required gear shall be done in accordance with current directives. The Rescue and Survival Systems Manual (COMDTINST M10470.10 (series)) describes required sources of supply for items that are applicable to both boat crewmembers and ATON crewmember. For items that are not covered under Organizational Clothing, as defined in the Uniform Regulations Manual (COMDTINST M1020.6 (series)), waivers shall be approved by the local Chief of Contracting Officers (COCO) prior to the procurement being made.

**A.2. Hardhats**



**Figure 3-1 Hardhat**

A hardhat (see **Figure 3-1**) provides impact protection to a wearer’s head. Some models protect the back of the neck from falling debris as well. Hardhats shall be worn at all times when conducting ATON or lifting or overhead operations. Hardhats shall meet American National Standards Institute (ANSI) standard Z89.1. In addition, hardhats shall:

- a. Be outfitted with a chin strap that is worn at all times.
- b. Be kept clean and free of unauthorized paint and stickers to allow for inspection for cracks and other deformities. The wearer’s name, rate, or nickname may be applied to the hat using stickers.
- c. Be outfitted with special attachments (face shield, hearing protection, etc.) for some specific operations (battery changing, power tool use, etc.).



- d. Hardhats shall be color coded to quickly identify the wearer’s assignment on deck:
  - (1) White: Safety Supervisor / Certified Deck Supervisor (not in the deck supervisor position)
  - (2) Yellow: Acting Deck Supervisor
  - (3) Blue: Certified rigger
  - (4) Green: Break-in rigger

**A.3 Personal Floatation Devices**

Personal floatation devices (PFDs) shall be worn by personnel working on or near the water. The type of PFD worn (Type III vest, anti-exposure coverall, dry suit, etc.) varies depending upon on scene conditions, the operations that will be carried out and Coast Guard policy.

**NOTE** 

**The Rescue and Survival Systems Manual - COMDTINST M10470.10 (series) maintains a list of approved PFDs for various Coast Guard operations (including boat crews), how each PFD shall be equipped, maintained, and the policy regarding when each type of PFD is authorized to be worn.**

**NOTE** 

**Inflatable PFDs are not authorized while actively working on the buoy deck or other aid to navigation due to their lack of inherent buoyancy and lack of impact protection in the event of flying debris.**

**A.4. Gloves**



**Figure 3-2  
Gloves**

Gloves are available in many different styles and protect the hands while handling lines, wire rope or chain as well as provide protection from the elements. Leather palm work gloves provide excellent protection, however gloves made of synthetic materials are becoming more popular. Gloves should fit snugly to help reduce the possibility of becoming fouled (especially during line handling). Depending on your operations and geographic location (cold weather/warm weather), several different styles of glove may be required. (See **Figure 3-2**)

**NOTE** 

**For cutting and burning, all leather welder’s gloves shall be worn by the torch operator.**

**NOTE** 

**While working with acid batteries, acid resistant gloves shall be used and sized accordingly.**



**A.5. Safety Glasses / Goggles**

Safety glasses/goggles (clear lens and sunglasses) are for general use on deck to protect eyes against flying debris and shall be worn at all times. Safety glasses/goggles shall meet ANSI standard Z87.1. Personnel with corrective lenses shall be issued prescription safety glasses (both clear and tinted) (See **Figures 3-3 and 3-4**). While handling batteries that contain acid, splash proof goggles or safety glasses and a hardhat with face-shield shall be worn.

**A.6. Safety Footwear**

The wearing of safety toed footwear is mandatory when working on the buoy/construction tender deck or other aids to navigation operations. This footwear provides impact protection for the wearer’s toes, better ankle support, and should be outfitted with non-skid soles. Like gloves, different styles of boots may be necessary to meet operational and climate requirements. Units that perform structure climbing should consider the use of boots with composite or steel shanks. Safety footwear shall meet American Society of Testing Materials International F2413 requirements. (See **Figure 3-5**)

**A.7. Acid Resistant Rubber Aprons**

An acid resistant rubber apron should be worn to protect against any breaks or leaks from the battery. (See **Figure 3-6**). Wearing of the apron may be waived at the OIC/CO/Coxswain discretion during evolutions that it may hinder an individual’s safety (i.e. tower climbing or walking on a jetty).

**A.8. Respirators**

While most buoy painting is done at the depot level, occasional touch-up may be required. For those workers assigned to painting, it is required that a properly fitted half-face respirator be worn with an organic vapor filter cartridge. (See **Figures 3-7 and 3-8**)

**NOTE** 

**Information regarding Pandemic Influenza and associated health concerns may be found in the Coast Guard Pandemic Influenza Force Health Protection Policy, COMDTINST M6220.12 (series).**

**NOTE** 

**Additional information and policies regarding respirators can be found in the Coast Guard Technical Guide for Practices of Respiratory Protection, COMDTINST M6260.2 (series).**

**A.9. Additional Gear**

In addition to the PPE already mentioned, the following pieces should be considered for issue:

- a. Foul weather work coat / parka
- b. Hearing protection
- c. Nitril Gloves





 <p><b>Figure 3-3</b> Clear Safety Glasses</p>	 <p><b>Figure 3-4</b> Tinted Safety Glasses</p>	 <p><b>Figure 3-5</b> Safety Boots</p>	 <p><b>Figure 3-6</b> Rubber Gloves and Apron</p>
 <p><b>Figure 3-7</b> Sample Respirator (w/o cartridge)</p>		 <p><b>Figure 3-8</b> Sample Respirator</p>	



This page intentionally left blank



## Section B. Operational Risk Management (ORM) and Safety Procedures

---

<b>Introduction</b>	While each type of ATON operation requires specific safety procedures, there are several practices that are common whenever engaged in any type of weight handling operation.
<b>B.1. ORM and Team Coordination</b>	The use of operational risk management and team coordination principles, contained in the Operational Risk Management, COMDTINST 3500.3 (series) and Team Coordination Training, COMDTINST 1541.1 (series), is crucial to reducing the probability of human error and breaking error chains before a mishap occurs. While technical skills are imperative to ATON operations, these alone will not ensure safety. For a mission that is inherently one of the most dangerous in the Coast Guard, coordinated teamwork is absolutely critical to operational success and safety.
<b>B.1.a Safety Briefings</b>	Safety briefings shall be conducted at the beginning of each day and at the discretion of the CO/OIC; debriefings shall be conducted at the end of each day and as required by the CO/OIC. These all-encompassing briefs will include risk assessment, clear expectations, and specific safety procedures. Briefings should also create a climate for learning and encourage feedback. Appendix (A) is the recommended format for an ATON deck briefing that can be amended to meet local needs.
<b>B.1.b ORM</b>	Operational risk management shall be a part of evolution planning and shall be included in safety briefings. Risks shall be reassessed as conditions change.
<b>B.1.c. Safety Briefings</b>	Safety briefings must empower subordinates to monitor circumstances and report changes that differ from originally planned evolutions or present hazardous conditions. Any time personnel have doubt as to what is happening they have a duty to speak up and seek clarification. By discussing risk, personnel will be more aware of potential hazards and how to control them. It is extremely important for a system of notification to be in place and known by every team member.

---



---

**B.2. General Safety**

The safety rules outlined below shall be followed whenever engaged in weight handling operations. Paragraph B.2.f describes what personnel **shall not** do.

---

**WARNING** 

**Inflatable PFDs are not authorized while actively working on the buoy deck or other aid to navigation due to their lack of inherent buoyancy and lack of impact protection in the event of flying debris.**

---

- a. Only authorized personnel should be on the buoy deck during weight handling operations.
  - b. When engaged in weight handling operations ensure that all taglines are properly staged and free from potential fouling.
  - c. Prior to any weight handling evolution, ensure that all safety gear, anti two-block devices, swing and extension limiters and all associated switches and alarms are inspected and operating properly. Any discrepancies shall be noted, immediately brought to the attention of the 1<sup>st</sup> LT, EO/EPO, and CO/OIC, and proper risk controls implemented before commencing operations.
  - d. Strobe lights or Personnel Marker Lights (PMLs) are required on all PFDs. When water temperatures are below 50 degrees, strobe lights shall be used in place of the PML.
- 

**B.2.e Personnel Shall:**

- (1) Wear appropriate PPE and protective clothing. This includes but is not limited to: hard hats (color-coded to indicate buoy deck position) with chinstraps, safety footwear, safety glasses or goggles, PFD, an accessible knife, hearing protection (as applicable), and gloves.
  - (2) Always control the load during a lift by using a tending line(s).
  - (3) Keep clear of all hooks, slings, and other gear that is under a load or is in the process of being loaded.
  - (4) Ensure the load is properly slung before hoisting.
  - (5) Watch for swinging hooks, slings, and gear.
-



**B.2.f Personnel Shall Not**

- 
- (1) Place themselves under a load or between a load and stationary object.
  - (2) Walk in front of a moving load – never turn your back to a load.
  - (3) Ride hooks, slings, shackles, or loads.
  - (4) Stand in the bight of line, chain, or wire.
  - (5) Use damaged or unserviceable hoisting equipment.
  - (6) Reach up to steady a load.
  - (7) Step over, straddle, or grab live chain by hand.
- 

**B.3. Open Hatches**

Observe the following safety practices whenever handling cargo near open hatches or in holds.

---

**B.3.a Personnel Shall**

- (1) Keep the hatch opening free and clear of any debris or other hazards.
  - (2) Assign a watch to guard or rig safety lines around open hatches when not engaged in loading.
  - (3) Illuminate hatches from the inside at night.
  - (4) Push the load in the desired direction, never pull.
- 

**B.3.b Personnel Shall Not**

- (1) Stand directly beneath the hatch opening if working in the hold while a load is overhead.
  - (2) Drop or throw anything between decks.
- 

**B.4 Cutting Torch / Cutoff Machine**

For cutters, a cutting torch or cutoff machine/saw shall be available on deck when working buoys and more than one crew member should be trained in its use.

---



This page intentionally left blank



## Section C. Pressure Treated Piles

---

<b>Introduction</b>	The Coast Guard uses wood piles and dimensional lumber to construct a variety of single- and multi-pile fixed aids to navigation.
<b>C.1. Chromated Copper Arsenate</b>	To make most piles and lumber more resistant to rot and destructive marine organisms, they are treated with solution of Chromated Copper Arsenate (CCA). CCA piles are commonly called "salt treated piles" and lumber as "salt treated lumber" because of the arsenic salts used in the preservative.
<b>C.1.a Untreated Piles</b>	ATON Structures that suffer high knockdown rates (reasonably expected to be destroyed within 12 months) may be constructed with untreated piles.
<b>C.1.b Creosote Piles</b>	In past years, creosote, a wood preservative distilled from tar, was used to preserve piles. Although this type of treated pile has not been used to construct ATON structures for many years, ATON servicing personnel may still encounter them in the field.
<b>C.2 Health Concerns</b>	Both CCA and creosote pose certain health risks to personnel and to the environment. The following information is provided for personnel working with either CCA or creosote impregnated wood.
<b>C.2.a CCA Precautions</b>	Although CCA treated piles and timbers have become the wood of choice for marine construction, there are still hazards associated with them. As the name implies the wood has been treated with chromate and arsenic salts, both of which are poisons. Arsenic poisoning can result from getting the poison (the greenish substance in the wood) on the skin, in the eyes, or from either inhaling or ingesting the dust from cutting.
<b>C.2.b Protective Clothing</b>	Goggles, respirator (with the proper filter), and long sleeves shall be worn when cutting CCA piles and lumber. Gloves shall be worn when handling these piles and lumber
<b>C.2.c Treatment of Exposure</b>	For eye(s) contact, flush with water for at least 15 minutes. For skin contact, wash with soap and water. If inhaled or ingested see a doctor as soon as possible.

---



**WARNING**  **CCA wood scraps shall not be burned. The fumes and ashes contain concentrations of chromate and arsenic.**

### C.3 Creosote

A carcinogen that is rapidly absorbed through the skin. Two of the most common dangers from creosote are infection and chemical burns. Infection often results from wood splinters and the evaporation of creosote can cause chemical burns. Just being in the vicinity of creosote, especially on hot days, can cause 2nd degree burns. The hotter the day, the quicker creosote evaporates causing burns unless adequate personal protection is worn.

#### C.3.a Protective Clothing

Wearing gloves and long sleeve shirts is required when working around creosote. Personnel working in close contact should wear coveralls or a neoprene apron and barrier cream. Contaminated clothing should be removed and cleaned before being used again. If these simple precautions are taken, creosote exposure is minimized. Goggles and an approved respirator are required when cutting piles or lumber.

#### C.3.b Treatment of Exposure

For eye(s) contact, flush with water for at least 15 minutes. For skin contact, clean the skin with alcohol and wash with soap and water. In all cases of severe contact with creosote see a physician as soon as possible. In almost all cases creosote wood products are to be treated as hazardous waste.

**WARNING** 

**DO NOT burn creosote piles or lumber. Burning creosote wood produces smoke that is toxic. Symptoms of inhaling these toxic fumes include visual impairment and difficulty with thought and speech. Prolonged exposure may result in vomiting, excessive salivation, respiratory difficulties, weak pulse, dizziness, headache, loss of reflexes in the pupil of the eye, hypothermia, and mild convulsions. If creosote smoke is inhaled, move the victim to fresh air, administer first aid and have the victim seen by a physician as soon as possible. If creosote is swallowed, have the victim drink water or milk, but do not induce vomiting.**





## Section D. Diving Operations

---

### **Introduction**

There has been an increase in the skill set and use of divers throughout the Coast Guard and they frequently conduct various ATON related missions. Guidance for diving operations is in:

1. Coast Guard Diving Policies and Procedures Manual, Vol I, COMDTINST M3150.1 (series)
2. Coast Guard Diving Policies and Procedures Manual, Vol II, COMDTINST M3150.2 (series)
3. US Navy Diving Manual, Current version.

If further consultation is needed/required, units should contact the regional dive locker for their respective AOR.

---



This page intentionally left blank.



## Chapter 4

# ATON Rigging, Loose Gear Cargo, Load Securing Equipment, and Deck Tools

---

**Introduction** This chapter introduces some common rigging hardware used on many aids to navigation vessels. All Aids to Navigation vessels shall maintain a Registry of Lifting Appliances, or 'Rigging Log', that identifies all rigging, rigging hardware, and load securing equipment, which includes wire rope, blocks, sheaves, hooks, links, slings, snatch blocks, load binders, pelican hooks, gripe chain, portable rigged block and tackle, etc. Specific guidance on the composition of this log is contained in the standard Aids to Navigation Registry of Lifting Appliances in section 4.A below.

---

**In this chapter** This chapter contains the following sections:

Section	Topic	See Page
A	Registry of Lifting Appliances Information	4-3
B	Fiber and Wire Rope	4-5
C	Loose Cargo Gear	4-25
D	Load Securing Equipment	4-35
E	Deck Tools	4-37

---



This page left intentionally blank



## Section A. Registry of Lifting Appliances Information

---

- Introduction** The Registry of Lifting Appliances, or more commonly referred to as the ‘rigging log’ is a very important historical document, especially in the event of a mishap. The registry shall contain the history of all wire rope, rigging hardware, and lifting equipment for its entire service life. This log is broken down into various sections for each particular piece of rigging equipment. Each section shall contain the history of that item including the manufacturer’s certification sheet (if required for that item), maintenance sheet, pull test sheets, weight test results, and any other correspondence that relates to the particular item. When filling out PMS sheets, ensure all information is recorded properly to include a serial number that matches the pull test certificate. It is recommended that if an item has a manufacturer’s serial number to use that number and not assign a unit specific number. This eliminates any confusion between the log, certificates, and the actual item. When an item is replaced and properly disposed of, all records for this item are to be removed from the Registry of Lifting Appliances and destroyed. A new record shall be started for the replacement item, if the item was replaced.
- 
- A.1. NATON Website** Due to the possibility of changes, all units shall use the current version of the Registry of Lifting Appliances as promulgated on the National Aids to Navigation School’s Buoy Deck Training Team website. The web address for this site is  
<http://cgweb.tcyorktown.uscg.mil/NATON/BDTT/resources.asp>.
- 
- A.2. Requirements** Every ATON unit shall follow the requirements and procedures for maintaining the Registry of Lifting Appliances as detailed in this section or at the NATON website described above. In the event of conflicting requirements, the guidance provided on the NATON website shall prevail. Questions regarding the unit Registry of Lifting Appliances may be directed to the NATON Staff or the applicable District ATON staff.
-



This page intentionally left blank.



## Section B. Fiber and Wire Rope

---

**Introduction** This section covers the construction, care, maintenance, and features of wire and fiber ropes. Wire and fiber ropes are key components of cranes, booms and davits and other equipment used during ATON operations.

---

**B.1. Fiber Rope** Fiber rope marlinespike seamanship information is contained in Chapter 7 of the Boat Crew Seamanship Manual, COMDTINST M16114.5 (series), appropriate chapters of the Naval Ships Technical Manual (NSTM), and other standard texts on seamanship, such as Knight's Modern Seamanship.

---

**B.2. Wire Rope Construction** Wire rope is a machine-made rope. The basic unit of wire rope is the individual strand wires processed from selected grades of steel. After the wires are drawn to size they are helically laid together in a uniform geometric pattern, a strand, with a definite pitch or lay. The strands are then twisted about a central core or heart of hemp, synthetic line, independent wire rope, or a steel center strand. Wire rope nomenclature is based upon the number of strands and the number of wires in each strand. All units should consult the equipment manuals and technical publications for the specific size and type wire to be used on each type of ATON equipment. Specific types of wire rope have been specifically engineered for the crane, A-frame, or davit and cannot be changed without approval of the Surface Forces Logistics Center (SFLC).

Most Coast Guard ATON units use 6-strand wire rope. The most common classes of 6 strand rope used with running rigging is either 6X19 or 6X36 (see **Figure 4-1**). These nominal classifications may or may not reflect the actual construction. For example, the 6X36 classification wire rope includes wire rope with 6X31, 6X36, 6X41, 6X43, and 6X49 constructions. Therefore, if a cutter orders 6X36 wire rope, the manufacturer could substitute any of the wire ropes described above and still meet the criteria for the 6X36 classification.

The number of wires in a strand will determine the wire rope's flexibility. The more wires, the more flexible the rope. What one gains in flexibility, one loses in abrasion resistance. Therefore, a 6X36 class wire rope is far more flexible than a 6X19 class, but the latter will be more resistant to abrasion as each individual wire is larger and more resistant to wear.

---



### **B.2.a. Wire Rope Core**

---

The core is the foundation of a wire rope. Its primary function is to support the wire strands under normal bending and loading conditions and maintaining them in their correct relative positions during the operational life of the rope. When subjected to a load, the strands, because of their helical shape, imbed themselves into the core. If the core is removed, broken, or weakened, the strands may deform, causing severe damage to the wire rope and potentially causing a reduction in breaking strength. The core also transfers lateral pressures from contact with sheaves or drums to the strands not making contact.

1. Fiber cores are simply small diameter fiber ropes. Most fiber cores (FC) are made of polypropylene. A fiber core provides maximum flexibility and elasticity to the wire rope structure. Fiber cores are susceptible to crushing due to their relative softness. Fiber core wire rope is used only on the 3 and 15 ton cranes on the Polar Class Cutters. They are also used with wire rope mooring systems typically used on the Western Rivers.
  2. Independent wire rope cores (IWRC) are usually small 6-stranded wire ropes with a strand as a core. Since they are a steel rope unto themselves they are more crush resistant than fiber core rope. IWRCs make a rope less flexible, but add about 7 1/2 percent to the breaking strength of the rope, depending on the termination fitting. The IWRC of a rotation resistant wire rope, like that used on the main of a WLB 'B' class and the WTGB class cutters, contains 50 percent of the breaking strength of the wire rope.
-





---

**B.2.b. Wires**

Typically the individual wires in a wire rope are round, however more and more they are being manufactured in different shapes designed to compact or lessen the space between each wire. Regardless of the shape of the wires, they are designed to slide and rotate against each other as the rope is loaded or bent. The grade of steel used in making the wires has a significant effect on the breaking strength. To a lesser degree the grade affects flexibility and abrasion resistance. The following grades of steel are used in wire manufacturing:

1. Plow steel (PS): lowest breaking strength, lowest resistance to wear, highest fatigue life.
  2. Improved plow steel (IPS): good combination of qualities; medium breaking strength, medium resistance to wear, medium fatigue life but with less flexibility.
  3. Extra improved plow steel (EIP/XIP): higher breaking strength, more resistance to wear, lower fatigue life and less flexibility. Used on some ATON platforms.
  4. Extra extra improved plow steel (EEIP/XXIP): highest break strength, most wear resistance and lowest fatigue life. Used on some ATON platforms.
  5. High strength: Breaking strength equal to or greater than EEIP/XXIP plow steel wire rope.
-

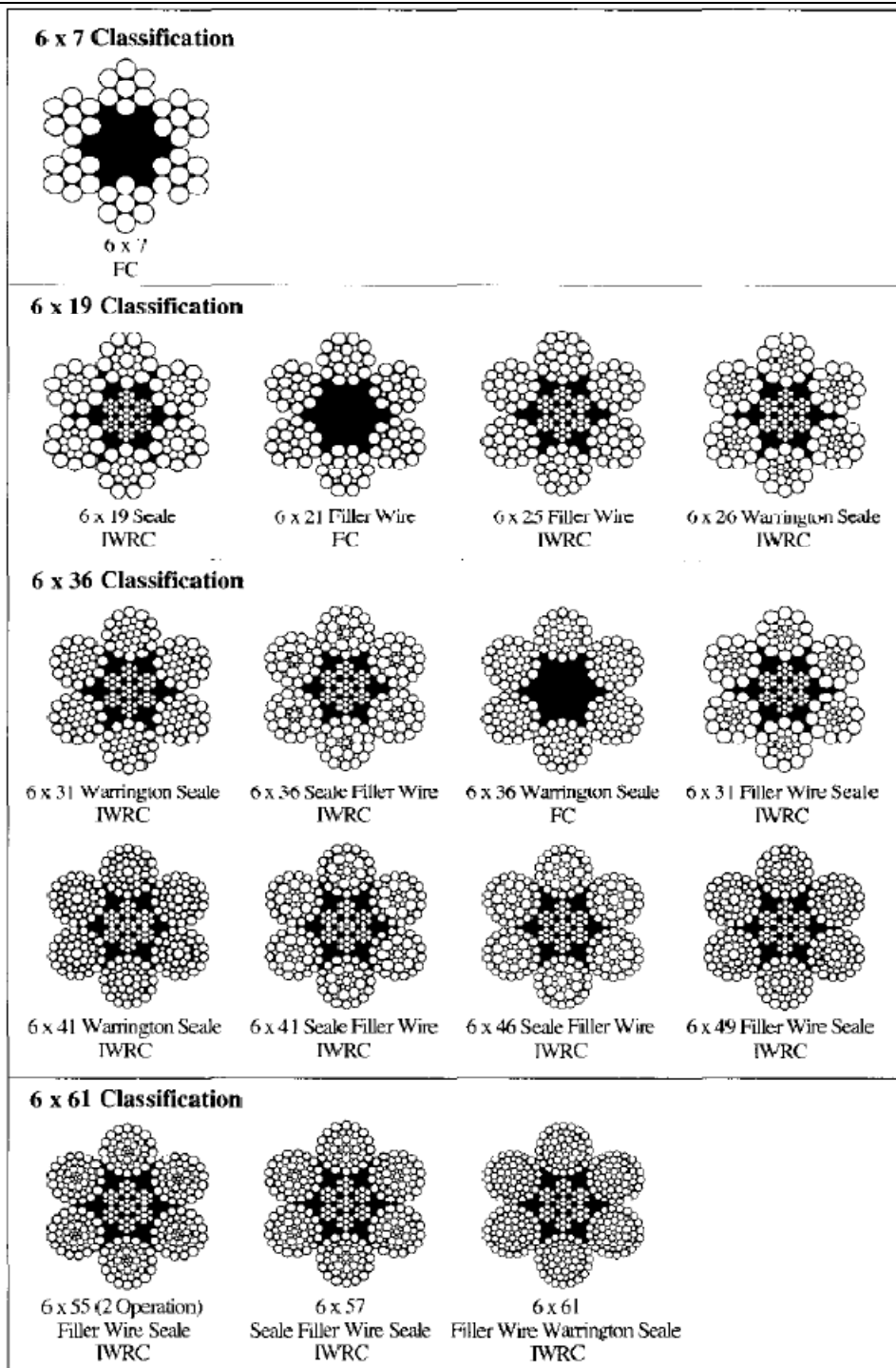

Figure 4-1  
Assorted Wire Rope Classifications



---

**B.2.c. Strands** Strands are made up of wires helically laid around the core. Unless otherwise specified in the vessel's plans, **all ATON vessels shall use six-stranded wire rope with an IWRC.** Newer vessels will normally use special construction wire ropes or 6 strand IWRC wire ropes. Changes to the wire rope type specified in ship's drawings or technical publications must be approved by the SFLC.

---

**B.2.d. Preformed Wire Rope** Preforming is a wire rope manufacturing process wherein the strands and their wires are formed during fabrication to the helical shape that they will ultimately assume in the finished rope or strand. Preformed wire ropes have many advantages over regular wire rope; they have greater flexibility, resist kinking, facilitate affixing end fittings, and wind smoothly and evenly on drums. All ATON vessels shall use preformed wire rope

---

**B.2.e. Rope Lay** Generally the rope lay is the direction that the strands twist around the wire rope's core. Specifically, the lay of a rope refers to the direction that the individual wires are twisted in a strand and the direction that the strands are wound around the core of a wire rope. When looking at a wire rope (See **Figure 4-2**), if the wires appear to run along the length of the rope it is known as regular lay. If the wires look as if they are running across the rope it is known as lang lay.

The following illustrations depict: (a) Right Regular Lay (RRL) (b) Left Regular Lay (LRL) (c) Right Lang Lay (d) Left Lang Lay and (e) Alternate Lay.

---

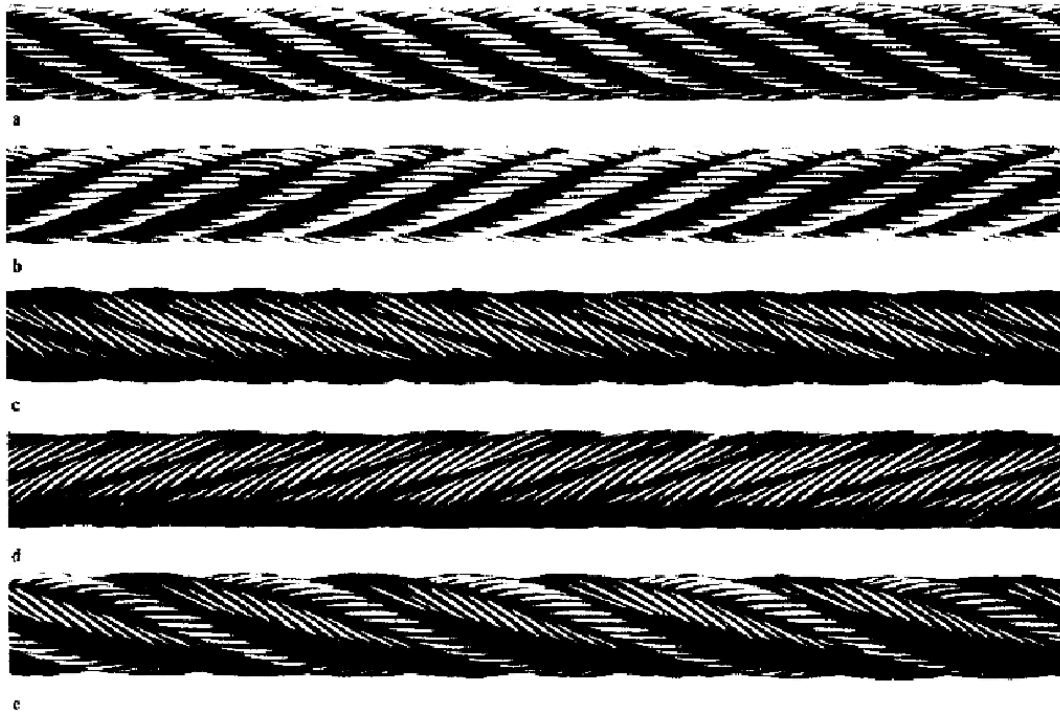

Figure 4-2  
Wire Rope Lays

- |                                       |  |
|---------------------------------------|--|
| <b>B.2.e.1. Right-regular lay (a)</b> | The individual wires of a Right-Regular Lay wire are laid up to the left and the strands are laid up to the right. Regular lay ropes are less likely to be kinked, and give additional resistance to crushing, distortion and rotation.  |
| <hr/>                                 |  |
| <b>B.2.e.2. Left-regular lay (b)</b>  | This lay is the opposite of Right-Regular Lay above.   |
| <hr/>                                 |  |
| <b>B.2.e.3. Right Lang Lay (c)</b>    | Both the wires of the strands and the strands are laid up to the right. Lang lay rope gives increased wearing surface for certain types of service resulting in longer life for the rope. Lang lay rope offers greater flexibility but has a tendency to crush and untwist. It should not be used with a swivel or in a single part hoist. |
| <hr/>                                 |  |
| <b>B.2.e.4. Left-Lang lay (d)</b>     | This lay is the opposite of Right-Lang Lay above.  |
| <hr/>                                 |  |



**B.2.e.5. Alternate lay (e)** Alternate lay ropes have limited use. They resist distortion and prevent clamp slippage, but sacrifice other advantages. The strands are laid to the right and alternate lay between regular and lang.

**B.2.e.6. Rotation Resistant** Advancements in wire rope construction have produced multiple core non-rotating wire rope and other special purpose constructions. Rotation resistant wire ropes are designed to resist the tendency to spin or rotate when placed under load (See **Figure 4-3**). In general these ropes are used as single part lines or in situations where operating conditions require a rope that will resist cabling (twisting) in a multipart system. Many of these ropes are only partially preformed; therefore the rope ends must be tightly seized and brazed to prevent lay disturbances of the outer strands or core. Care must be taken to avoid inducing twist into the rope during handling and installation. Rotation resistant wire rope shall only be used and rigged as specified by the vessel's drawings and technical publications.

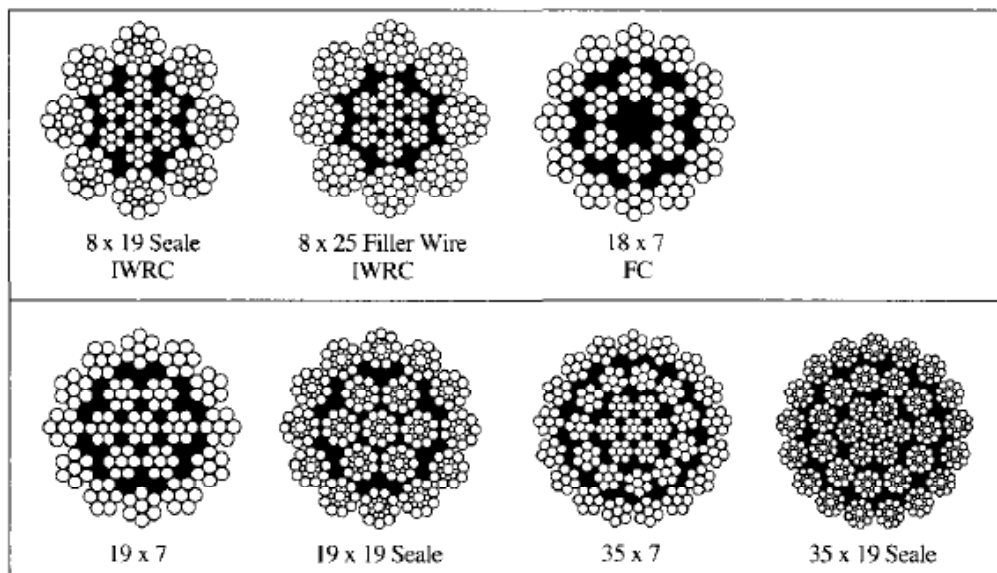

**Figure 4-3**  
Cross Sections of Rotation Resistant Wire rope

**B.2.e.7. Compacted Strand Wire Rope.** Manufactured from strands which have been compacted or reduced in diameter. The compacting process flattens the surface of the outer wires and reforms internal wires of the strand to increase density of the strand. The result is a smoother bearing surface at the strand crowns and an increase in the minimum breaking force over round strand rope of the same diameter and classification.

**NOTE** 

Compacted strand wire rope **shall only** be used and rigged as specified by the vessel's drawings and technical publications.

**B.2.f. Diameter**

The diameter of a wire rope is the distance between the crowns of two opposite strands (see **Figure 4-4**). This is easily measured by rotating a caliper around the rope so the highest points are measured. Ropes are referred to by their nominal diameter. New wire rope is manufactured from 5-8 percent larger than the nominal diameter.

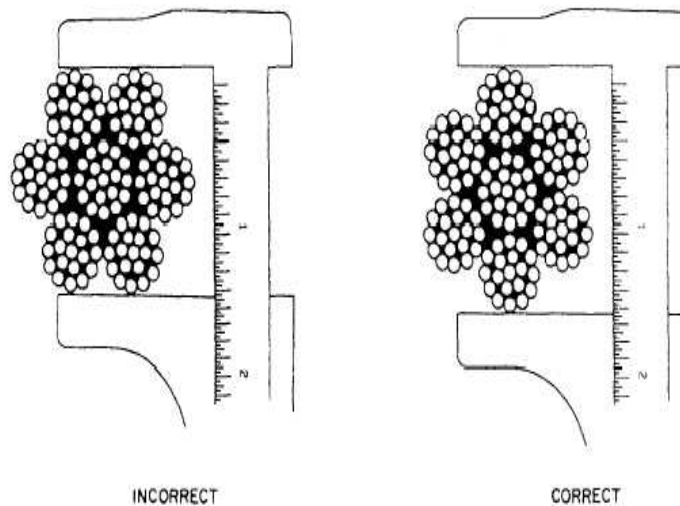

**Figure 4-4**

**The incorrect and correct way of measuring wire rope.**

**B.2.g. Lay Length**

A rope lay length, an important dimension to measure during routine inspections, is the distance it takes one strand to go completely around the core (See **Figure 4-5**). This is easily determined, if the number of strands is known. Start at one strand and count the strands down the rope until the number equals the number of strands or follow a strand from the top of the rope around the entire wire rope back to the top of the rope. The distance between these two points is the lay length.

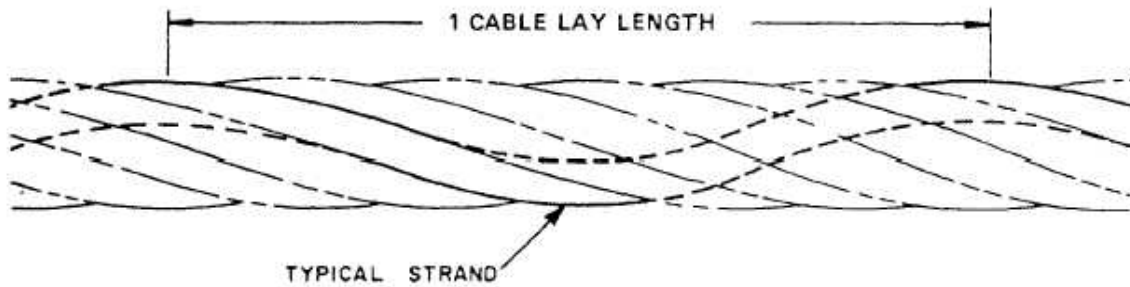

Figure 4-5  
Lay Length

**B.3 Physical Properties**

Physical properties of wire rope consist of the breaking strength, Working Load Limit (WLL)(formerly known as the Safe Working Load or SWL), and flexibility.

**B.3.a Breaking Strength**

The breaking strength of a wire rope is set by the manufacturer and is the load that will part the rope when new. **Table 4-1** shows the minimum breaking strengths for commonly used wire ropes. All ropes within a given classification, with the same diameter and grade of steel, have the same breaking strength.

Wire Rope Size & Classification	Breaking Strength	WLL
1/4" 6X19 RRL EIP IWRC	6900 lbs	1380 lbs
3/8" 6X41 RRL EIP IWRC	15100 lbs	3020 lbs
3/8" 6X36 RRL EIP IWRC	15100 lbs	3020 lbs
7/16" 6X36 RRL EIP IWRC	20400 lbs	4080 lbs
1/2" 6X19 RRL EIP IWRC	26600 lbs	8240 lbs
1/2" 6X37 RRL EIP IWRC	26600 lbs	5320 lbs
5/8" 6X25 RRL EEIP IWRC	45400 lbs	9080 lbs
5/8" 6X19 RRL EIP IWRC	41200 lbs	8240 lbs
5/8" 6X36 RRL EIP IWRC	41200 lbs	8240 lbs
3/4" 6X36 RRL EIP IWRC	58800 lbs	11760 lbs
7/8" 6X36 RRL EIP IWRC	79600 lbs	15920 lbs
1 1/8" 6X36 RRL EIP IWRC	130000 lbs	26000 lbs
1" 19X7 Rotation Resistant	84400 lbs	16880 lbs

**Table 4-1**  
**Breaking Strength and WLL for common ATON Wire Rope**

**B.3.b. Working Load Limit**

To find the WLL of new wire rope, divide the breaking strength by a design factor chosen for the particular conditions of use. For example, rope used in ordinary hoisting service shall have a design factor of five. Wire



---

	<p>rope used for personnel lifting must have a minimum safety factor of seven. (This means it must be capable of supporting seven times the maximum intended load.) Rotation resistant rope used for personnel lifting must have a minimum safety factor of ten.</p>
<b>B.3.c. Flexibility</b>	<p>The number of wires and the type of core have a significant effect on a rope's flexibility. Flexibility is important in multiple part reeving and situations where only small diameter sheaves can be used. Obviously, the more wires and the softer the core the more flexible the rope. For example, a 6x37 rope is 40 percent more flexible than 6x19 rope of the same size, grade and core type. The opposite is true of crush resistance. The fewer wires and the harder the core, the more crush resistant. For example, a 6x19 rope is 30 percent more crush resistant than a 6x37 rope of the same size, grade and core type.</p>
<b>B.4. Designations</b>	<p>Wire rope is described by length, diameter, classification, preformed or non-preformed, direction and type of lay, wire finish, steel grade, and type of core. When ordering wire rope, include all of the designations, for example: 600' of 1-1/8" 6x37 PRF RRL EIP IWRC. (Note: unless the wire finish is other than bright, then including the wire finish is not necessary.)</p>
<b>B.5. Installation and Selection</b>	<p>Consult standard ship's drawings or appropriate ship specific technical pubs to determine the proper size and type of wire rope for standing or running rigging. Deviation from these blueprints or technical pubs is not authorized without an approved TCTO from SFLC.</p>
<b>B.5.a Transferring Wire Rope to the Winch Drum</b>	<ol style="list-style-type: none"> <li>1. Winch drums typically have one anchoring point either on the right or left side of the drum. The winch drum's anchoring point and the direction of its rotation will determine the lay of the wire rope to be installed (see <b>Figure 4-6</b> for the "Thumb Rule")</li> <li>2. Some winch drums allow for anchoring on two sides, either the right or left. The direction of the lay of the rope determines which anchoring point to use. Each time a drum is rigged the correct lay/anchoring point should be checked. The procedure for determining the anchor point is as follows:             <ol style="list-style-type: none"> <li>a. Determine if the rope will be over wound or under wound. Will it come off the top or bottom of the drum?</li> <li>b. Place yourself behind the drum.</li> <li>c. For <u>right</u> lay rope, make a fist with your <u>right</u> hand to simulate the drum, and extend your forefinger to simulate the rope. If the rope is over wound the back of the hand must be up so the forefinger</li> </ol> </li> </ol>

---





- 
- "comes off the top of the drum" just like the rope. If the rope is under wound the palm would be up so the forefinger "comes off the bottom of the drum" like the rope.
- d. With your hand in the correct position extend your thumb. The thumb points to the side where the anchoring must be done.
  - e. Left lay rope should be treated in an opposite manner (see **Figure 4-6** for the "Thumb Rule")
3. When transferring wire rope from a shipping reel to a winch drum, the reel must be allowed to rotate freely but under control. Ensure that the wire rope is un-spoiled from the top of the shipping reel to the top of the drum or from the bottom of the shipping reel to the bottom of the drum (see **Figure 4-7**). Installing the wire rope in this manner prevents placing a reverse bend into the rope. Never go from the top of the reel to the bottom of the drum or vice versa.
  4. Wire rope that is in a coil should be stood on the edge of the coil and rolled like a wheel. When hand coiling wire rope, coil it in the direction that will take the twist out of the rope. (Example: Right-lay rope should be coiled in a clockwise direction.)
  5. On the first layer, make sure that all wraps are installed straight and tight. Use a soft object (wooden mallet) to ensure that the wraps are straight. A wire rope lubricator secured to a deck padeye places a sufficient strain on the wire rope while it's being installed on the winch drum. A uniform and closely wound first layer will produce uniform successive layers. A loose first layer will lead to kinking, crushing and over winding. Once the wire rope has been replaced on a drum, light weights should be lifted to help seat the wire. These weights should be gradually increased until a dynamic weight test has been completed.
  6. Finally, take initial diameter and lay length measurements after the dynamic weight test has been completed.
-

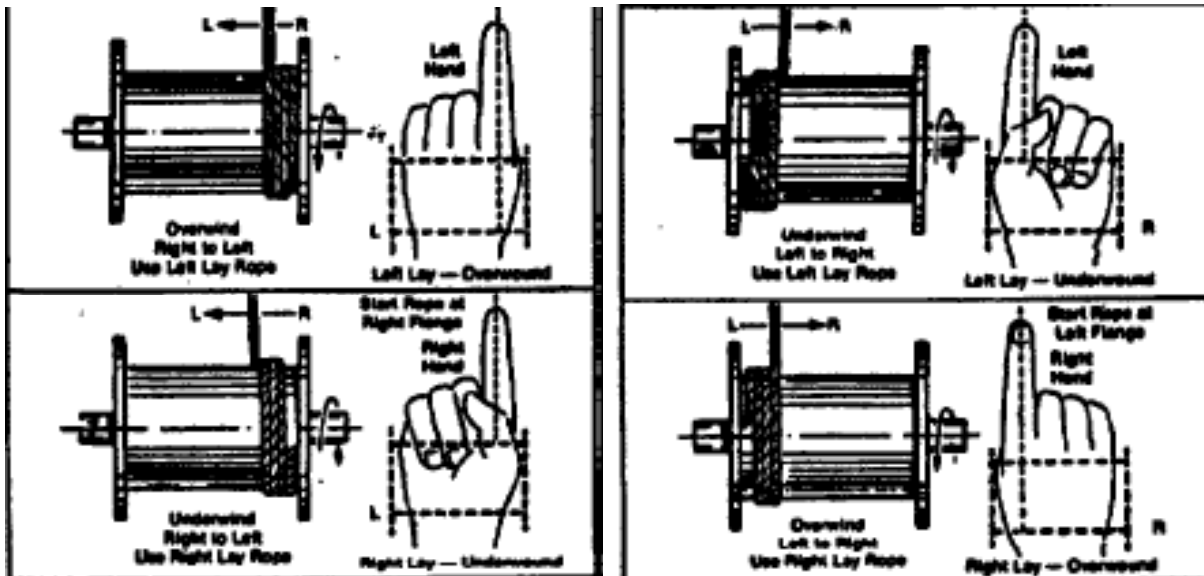

Figure 4-6  
Proper Method of Locating Rope Anchorage Point on a Drum.

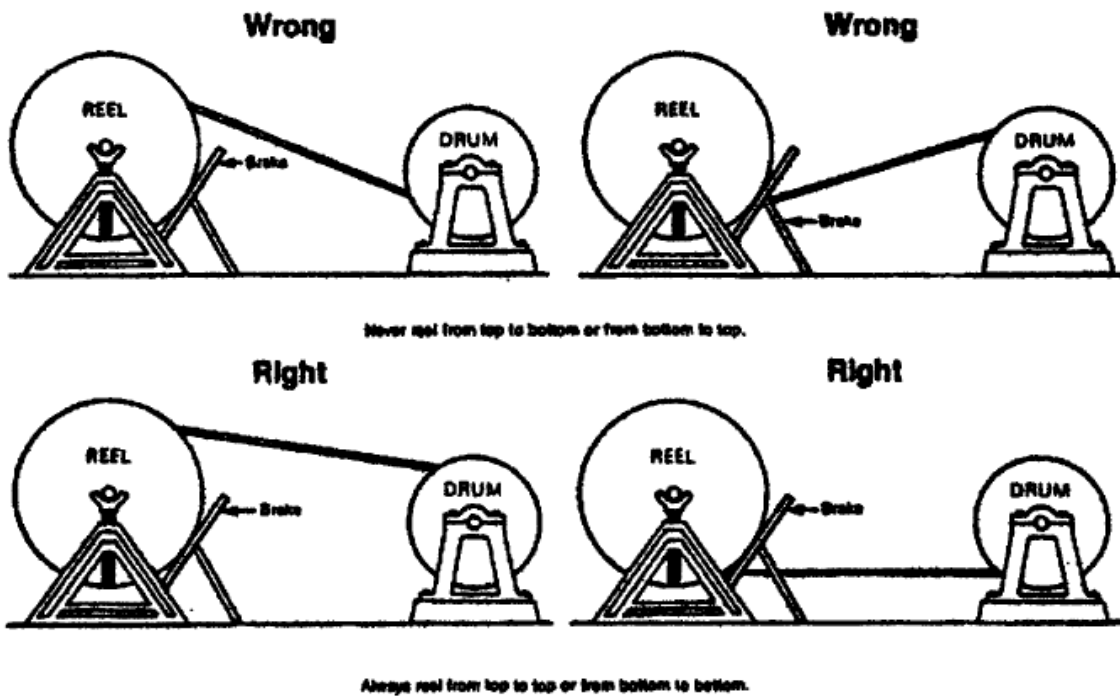
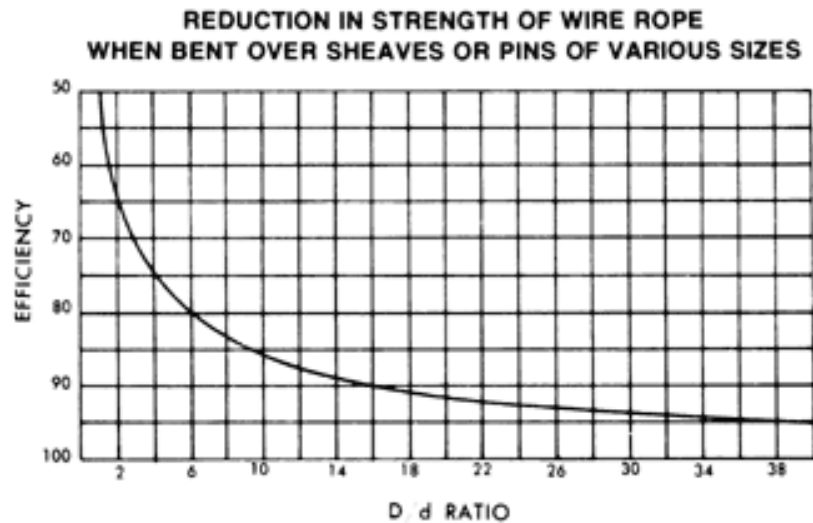

Figure 4-7  
The Correct and Incorrect Way to Wind Wire Rope from Reel to Drum.



## B.6. Rigging Considerations:



**Figure 4-8  
Efficiency and D to d Ratio Graph**

### B.6.a. D to d Ratio (D/d)

- (1) When wire rope is bent over a sheave or drum, a load-stretch is introduced. This condition results in strength reduction of the wire rope. The relationship between sheave/drum diameter (D) and the wire rope diameter (d) as it is bent around the sheave/drum is expressed as a (D/d) ratio. Additional friction is encountered in the wire rope as it adjusts – from the movement of the wires and strands – while bent around the sheave or drum. The smaller the ratio of sheave/drum diameter is to the rope diameter (D/d), the greater the adjusting movement and the greater the strength loss of the wire rope. **Figure 4-8** shows the reduction in the efficiency (percent of breaking strength) of a wire rope based on the sharpness of the bend. For this reason most wire rope manufacturers conform to ANSI/ASME standards which recommends a minimum of 15:1 (D/d) ratio for pulling/hauling applications and a minimum of 18:1 (D/d) ratio for lifting and lowering applications.
- (2) Compute “D to d” ratio by dividing the sheave/drum's tread diameter (D) by the wire rope's nominal diameter (d). For example, a 7/8 inch wire rope going over an 18 inch sheave will have a D/d ratio of: 20.6 to 1 (18 divided by 7/8 (.875) = 20.6). Per **Figure 4-8**, the actual breaking strength of the wire rope in the above example is 92.5 percent of its cataloged strength. The D/d ratio effect is not additive, i.e. If a wire rope is rove through a number of sheaves, the smallest sheave diameter will determine the wire rope's breaking strength.



- 
- (3) The size of the sheaves/drums on installed hoisting systems aboard Coast Guard vessels are predetermined and shall not be altered without proper approval through the Coast Guard's Time Compliant Technical Order (TCTO) process.
- 

### **B.6.b Fleet Angle**

- (1) Fleet angle is the angle between the center line that runs through the first fixed sheave perpendicular to the axis of the drum shaft and the line from the sheave to the extreme left or right side of the drum (**See Figure 4-10**). It exerts the greatest influence on winding characteristics. For optimum efficiency and service characteristics, the angle should not exceed 1 1/2 degrees for a smooth drum, or 3 degrees for a grooved drum (**See Figure 4-9**). Larger fleet angles cause excessive sheave, wire rope, and drum wear. They may also lead to jumping or skipping turns when rising from one layer to the next which could result in shock loading and / or the wire rope to pile up on one side of the winch drum.
- (2) Since the fleet angle on installed hoisting systems aboard Coast Guard vessels has been predetermined and built into the system, additional consideration is not typically necessary. However, fleet angle must be considered when positioning a fairlead (snatch) block.
- 

### **B.6.c. Calculating Rope Length**

The length of wire rope wound on a reel or drum can be determined by using the following method: Measure the depth of material (H) wound on the reel. Add this figure to the diameter (S) of the drum (hub). Multiply this sum by the depth (H), then multiply the product by the inside length (L) of the drum. Then multiply by a constant (K) for the respective size of rope. The result (X) will be the length of rope on the reel. All of the measurements are in inches and the length of the rope will be in feet. The formula is  $[(H + S) H \times L] K = X$ . Example H = 6 inches, S = 18 inches, L = 24 inches, K = 1"  $[(6+18)6 \times 24 \times 1 = 3456$  inches or 288 feet.

---

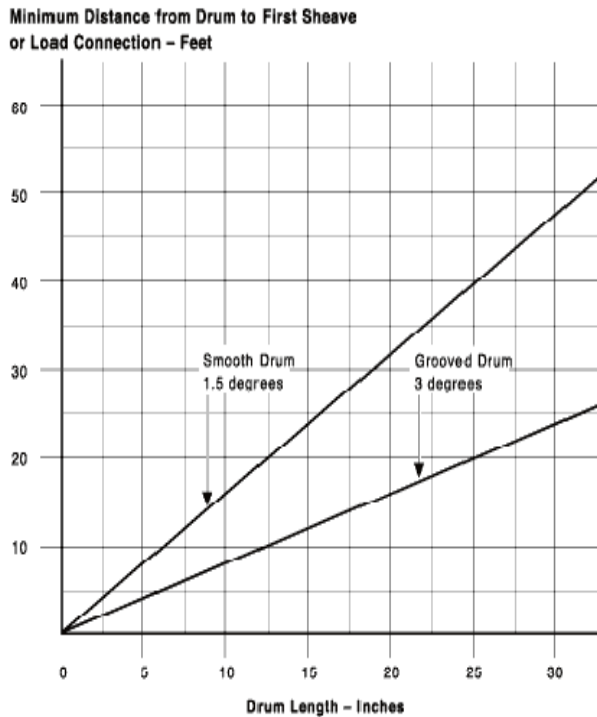

**Figure 4-9**  
**Drum to Sheave Distance Table**

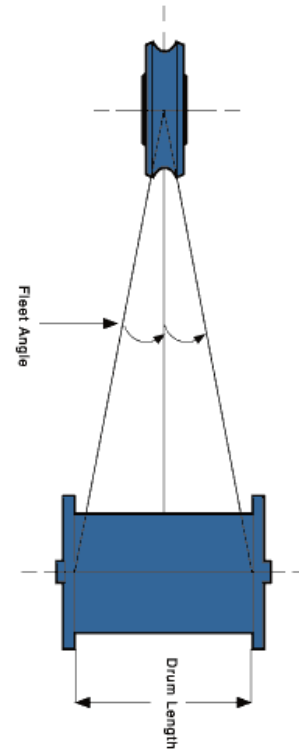

**Figure 4-10**  
**Fleet Angle Drawing**

**B.7. Lubrication:**

Wire rope must be properly lubricated to ensure long life and safe operation. The internal parts of the wire move whenever the rope passes over a sheave, winds on a drum or is put under a load. To limit internal wear and corrosion of the wire rope, units shall lubricate all wire rope at installation, during level I inspections, and at least annually (more often as necessary). All lubricants must be free from acids and corrosive substances and be thin enough to remain as a coating on the outer surfaces. Care must be taken to ensure the lubricant penetrates into the core of the rope. The required method of lubricating wire rope is to use a pressure lubrication system if available for the wire rope in question.

**B.8. Inspection / Replacement**

- (1) Wire rope shall be visually inspected for obvious deficiencies or defects prior to use.
- (2) Wire rope shall be externally inspected quarterly for wear, defects, and proper lubrication.
- (3) In addition to the external quarterly inspection, wire rope shall be



---

unshipped and lubricated at least annually. This inspection is typically accomplished in conjunction with the level 1 crane inspection.

- (4) Specific lubrication, inspection, and replacement criteria for wire rope are contained in the Coast Guard Naval Engineering Manual COMDTINST M9000.6 (series) Chapter 613.
- 

**NOTE** 

Wire rope that has not been in use for 30 days or more **shall** be subject to a quarterly inspection.

---

**B.9. End Fittings**

This section covers the authorized end fittings for wire rope used in various applications in the Coast Guard. Installation instructions and procedures mentioned within this section are not to be used in place of applicable manufacturer's instructions.

---

**B.9.a. Cutting and Seizing Wire Rope**

Hydraulic, mechanical, or guillotines rope cutters are recommended for cutting wire rope. Torches shall never be used to cut wire rope. To prevent the stands from spreading, seizing should be placed on either side of the planned cut location. The most important factors in the seizing of any rope are that the rope does not deform and the rope lay does not change when the rope is cut. The following are the recommended steps for seizing wire rope:

- (1) Wrap seizing wire onto the rope by hand, applying enough tension to keep the coils tight. (See **Figure 4-11**).
  - (2) Once the proper width of the seizing is obtained (at least equal to the rope diameter) twist the ends of the seizing wire together counter-clockwise. If done correctly, the twisted portion of the wire ends should be in the middle of the seizing.
  - (3) Tighten the seizing by prying the twist away from the axis of the rope.
  - (4) Tighten the twist again.
  - (5) Repeat (3) and (4) as often as necessary to make the seizing tight. Then trim the ends of the wires and pound the twist close against the wire rope.
-

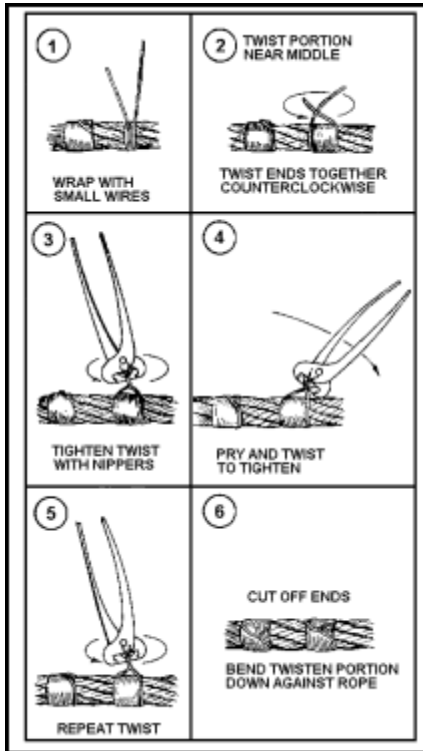

**Figure 4-11**  
Wire Rope Seizing

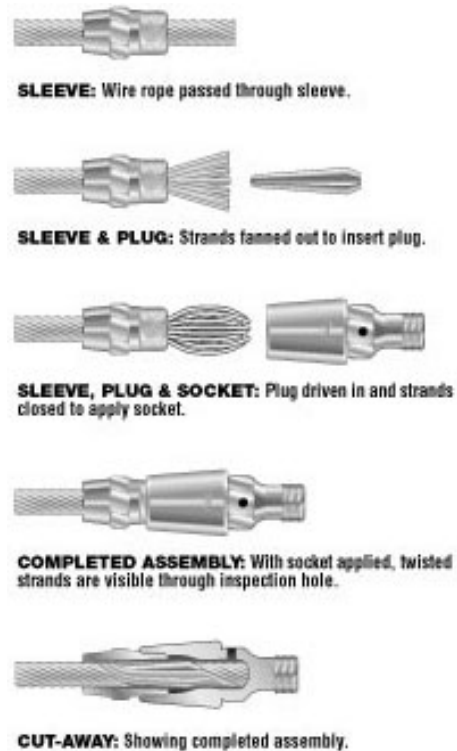

**Figure 4-12**  
Fiege Fitting Assembly

**B.9.b. Fiege Fittings**

Fiege fittings when properly assembled are rated at 100% efficiency of the wire rope and are authorized for all rigging applications. Made of three parts, fiege fittings include a sleeve that slips over the end of the wire rope, a split plug that is inserted to separate and hold the strands of the rope in the sleeve, and a covering socket that serves as a vibration dampener. The fiege fitting works on a wedge principle. The plug is tapered as is the inside of the sleeve. Due to the friction between the strands and the plug, the plug is drawn deeper into the sleeve as a load is placed on the rope. The tapers of the plug and sleeve combine to wedge the strands between them, thus holding the rope. A sample illustration of how install a fiege fitting is shown in **figure 4-12**. For complete installation, refer to the manufacturer’s provided instructions or Naval Ship’s Technical Manual (NSTM), Chapter 613. When using an electroline fitting on a wire rope with a grade of XXIP or higher, order by grade and size of wire. A standard electroline fitting of appropriate size has a lower breaking strength than its respective wire rope.



**B.9.c. Poured  
(Spelter) Sockets**

There are two primary types of material used in poured sockets for wire rope; zinc and epoxy resin. When assembled correctly, these fittings are rated at 100% efficiency of the wire rope and are authorized for all rigging applications. Zinc fittings shall only be attached to wire rope by competent commercial vendors, who shall certify the fitting in writing. Epoxy resin fittings can be installed by ship's force following the manufacturer's instructions or procedures outlined in Naval Ship's Technical Manual (NSTM) Chapter 613.

**NOTE** 

Feige and Poured Socket Fittings: Ensure you paint the section of the wire rope where it enters the end fitting with white paint so that if the wire slips it will be readily apparent.

**B.9.d. Pressed  
(Swaged)  
Fittings**

These end fittings are typically used to permanently terminate an eye in wire rope. They are commercially manufactured by hydraulically pressing a steel sleeve on the throat of the eye. When assembled correctly, these fittings are rated at 97 to 100% efficiency of the wire rope. Although not normally used in running rigging, pressed fittings are ideal for standing rigging and wire rope sling applications.

**B.9.e. Wedge  
Sockets**

Wedge sockets are the simplest fittings because of their ease and speed of applying and detaching. **Wedge fittings are authorized only for spud winches.** A wedge socket can withstand approximately 80 percent of the breaking strength of the rope. An illustration of a generic installation of a wedge socket is shown below (**figure 4-13**). For specific installation instructions, refer to the manufacturer's instructions.

**NOTE** 

The new generation of wedges, such as the Crosby Terminator, are recommended for use. This type of wedge allows for the installation of a wire rope clip on the wedge that prevents the wedge from inadvertently slipping.



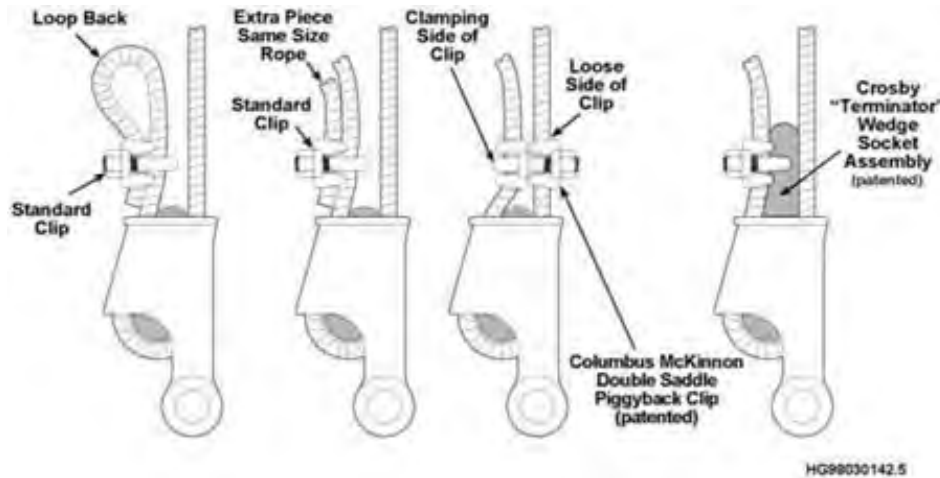

Figure 4-13  
Sample Wedge Socket Installation

### B.9.f. Wire Rope Clips

- (1) Wire rope clips are a **temporary** end fitting solution. They may be used in some aid to navigation structure construction, to form a temporary eye in a mooring cable, or other general-purpose temporary rigging. **Wire rope clips shall not be used for slings or overhead weight handling applications.**
- (2) When attaching wire rope clips, be sure that the U-bolt rests on the short or bitter end of the rope and that flat base (saddle) rests on the tension part (see **Figure 4-14**). A useful mnemonic device “Never saddle a dead horse” can be used to remember this rule. The distance between clips should equal six (6) times the diameter of the wire. Tighten the wire rope clips, apply a load to test the assembly, gradually increase the load and then check and retighten wire rope clip nuts to manufacturer’s recommended torque. The number of wire rope clips that should be used to develop maximum strength is listed in **Table 4-2**. A termination made in accordance with the above instructions, using the proper number of clips has an approximately 80% efficiency rating.

### B.9.g. Wire Rope Splices

Non-commercially made wire rope splices shall not be used for slings or overhead weight handling applications in the Coast Guard. For more information on wire rope splices, consult the Naval Ships Technical Manual (NSTM), chapter 613.

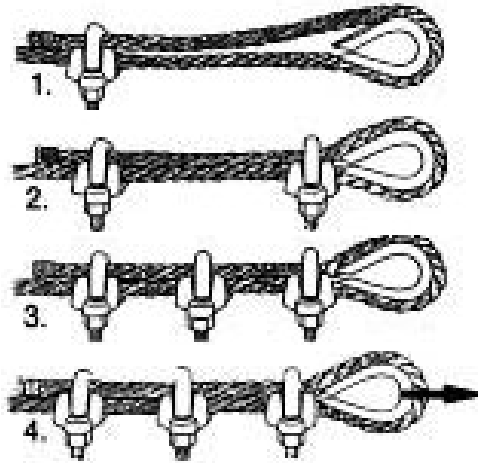

**Figure 4-14**  
Wire Rope Clip installation Process

Size of Clips (Corresponding to Rope Diameter in inches)	Number of Clips to Develop Max. Strength
1/2	2
5/8	3
3/4	3
7/8	4
1	4
1 1/8	5
1 1/4	5
1 1/2	6

**Table 4-2**  
Number of Clips required for various Wire Ropes

**B.9.h.**  
**Additional**  
**References**

As stated throughout this text, more detailed information on the care and handling of wire rope is contained in Naval Ship's Technical Manual (NSTM), Chapter 613, Naval Engineering Manual COMDTINST M9000.6 (series), Wire Rope User's Manual, and other standard texts on seamanship.



## Section C. Loose Cargo Gear

---

<b>Introduction</b>	All equipment or appendages that could be used for overhead lifting applications: such as but not limited to; hooks, chain slings, swivels, links, pins and shackles shall be manufactured from grade 8 or better alloy steel and stamped with the working load limit (WLL) on each piece of gear by the manufacturer, or be marked or tagged by the manufacturer so the working load limits can be readily determined. If the WLL cannot be determined by consulting a manufacturer's table or the unit's Registry of Lifting Appliances for any of this gear, then that piece of gear shall be destroyed and disposed of in such a way as to prevent it from further use.
<b>C.1. Blocks</b>	Blocks are identified by any number of their characteristics including but not limited to: number of sheaves, rigging material (wire rope, fiber rope, etc.), WLL, purpose, position, material from which they are manufactured, their particular shape, etc. The most common types of blocks used on ATON vessels are wire rope, steel shell, crane/boom blocks, snatch blocks, and wooden or steel shell fiber rope blocks. Any block used aboard ATON vessels shall be of the proper size (using the D to d ratio) and type for use with either natural or synthetic fiber line or wire rope and shall be stamped with the working load limit of the block. Specific inspection and replacement criteria for blocks are contained in the ATON Registry of Lifting Appliances. The essential parts of any block are the sheaves, center pin, shell, strap, and connections.
<b>C.1.a. Sheaves</b>	Sheaves transmit the load imposed by the rope to the center pin and connections. The rotation bearing surface consists of either bronze bushings or roller bearings. The groove of wire rope sheaves are specifically sized for the size of wire rope to be used. The condition and size of the groove is periodically checked for compliance using a sheave gauge. Proper lubrication of the rotation bearing surface must be periodically inspected, as it is critical to safe and efficient operation of running rigging. Specific inspection, repair, and replacement criteria of sheaves are contained in the ATON Registry of Lifting Appliances.
<b>C.1.b. Other Block Components</b>	Specific inspection, repair, and replacement criteria of these other components are contained in the ATON Registry of Lifting Appliances.

---



---

<b>C.2. Tackle</b>	A tackle is a purchase in which two or more blocks are rove together to gain a mechanical advantage. On ATON vessels tackles are typically rove with synthetic or natural fiber line and used for a variety of small tasks. The following are some of the more common tackles used aboard ATON vessels (see <b>Figure 4-15</b> ).
<hr/>	
<b>C.2.a. Single Whip</b>	A fixed single block with a line rove through it, one end of which is secured to the weight to be moved. Since there is no movable block, it does not multiply the force applied. It does change the direction of pull and furnish a convenient method of hoisting (see <b>Figure 4-15</b> ).
<hr/>	
<b>C.2.b. Runner</b>	A single movable block attached to the load. The part of the line running from the block to a fixed point is the standing part. The mechanical advantage is 2:1.
<hr/>	
<b>C.2.c. Whip and Runner</b>	Two single blocks, one fixed, but not over the load, and one block attached to the load. The mechanical advantage is 2:1.
<hr/>	
<b>C.2.d. Gun Tackle</b>	Two single blocks, one fixed over the load, the other attached to the load, the standing and the hauling parts leading from the same block. Mechanical advantage is 2:1 or 3:1, depending upon which block is attached to the weight.
<hr/>	
<b>C.2.e. Luff, Jigger, or Watch Tackle</b>	A combination of a double and a single block. When the single block is attached to the weight, the mechanical advantage is 4:1. A combination of a triple and a double block with the standing part secured to the becket of the lower (double) block is known as a double luff tackle.
<hr/>	
<b>C.2.f. Two-Fold Purchase</b>	This consists of two double blocks with the standing part and hauling part coming from the same block. The mechanical advantage is 4:1 or 5:1.

---

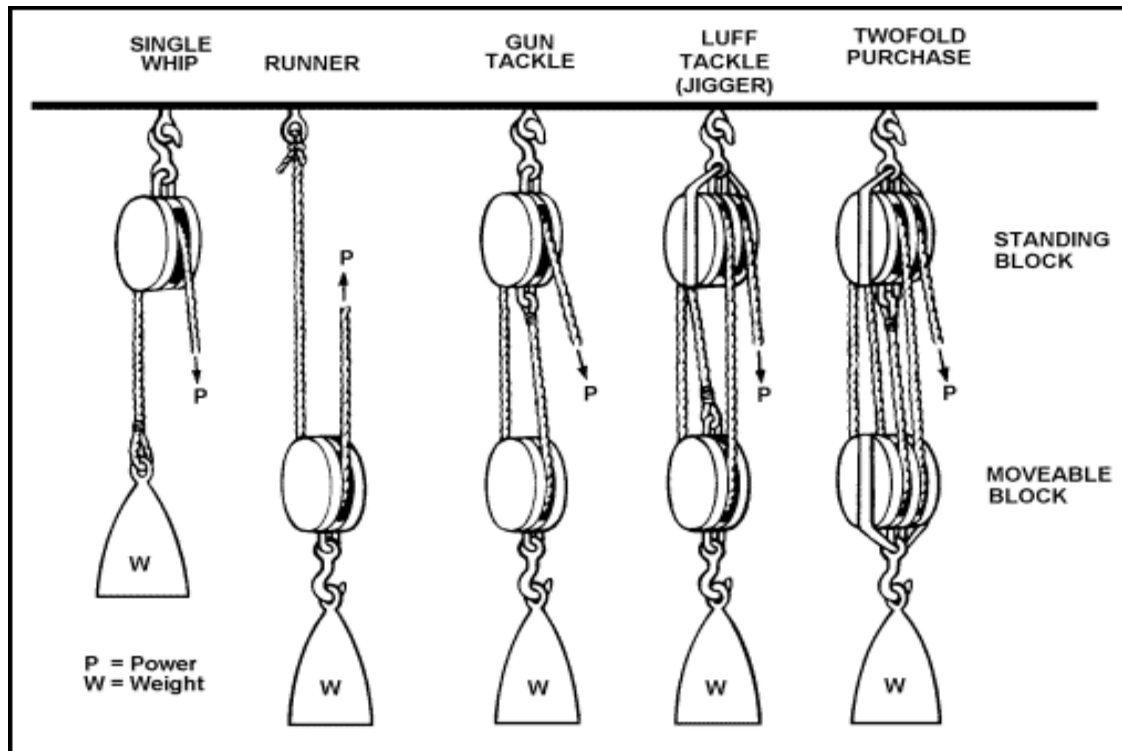

Figure 4-15  
Sample Block and Tackle Arrangements

### C.3. Swivels

Swivels in running rigging are necessary to limit rotation of a load. All swivels must be properly sized for the rig in which they are placed. Swivels shall be inspected before each use to ensure that it rotates freely. Failure of the swivel to rotate properly requires disassembly and inspection for bearing wear and lubrication. Some of the smaller swivels may need to be replaced in lieu of disassembly. Specific inspection, repair, and replacement criteria of swivels are contained in the ATON Registry of Lifting Appliances.

### C.4. Various Rigging Links

Rigging links include master links, master link assemblies, connecting links, etc. Paragraph E.1 specifies manufacturer requirements. Specific inspection and replacement criteria for various rigging links are contained in the ATON Registry of Lifting Appliances.



**C.5. Hooks**

All load lifting hooks shall be forged, made of alloy steel, and properly rated for the rig in which they are installed. They shall be visually inspected before each use. Hooks used in rigging shall be moused. Specific inspection and replacement criteria for hooks are contained in the ATON Registry of Lifting Appliances.

**C.6. Pelican Hooks**

Pelican hooks are extremely useful in stopping off buoy mooring chain. Originally designed to secure a ship's anchor at the hawse pipe, pelican hooks are not required to have a WLL stamped on them. It is generally held that the hook will safely hold any load that any proper sized chain, regardless of type, will hold. **Heat treated alloy chain and hardware shall be used to secure a pelican hook to the deck and this assembly shall be proof tested and certified.** Specific inspection and replacement criteria for pelican hooks are contained in the Aids to Navigation Registry of Lifting Appliances.

**C.6.a. Design**

Pelican hooks are designed for the size of chain(s) for which they are rated. For example, to stop off 1-1/2" chain a 1-1/4" to 1-5/8" size pelican hook is employed. The hook works by placing one link of chain between the base and tongue. The tongue is then rotated until it can be secured with the tripping bail. The tripping bail is secured with the retaining pin, which is moused. Since the Pelican Hook is designed to be released in the upright position, a strong-back shall be attached to the pelican hook to prevent it from flipping.

Chain Size	A	B	C	D	E	F	G	H	Proof Test Lbs.	Weight Lbs.
3/4HS* & 3/4	7/8	7/8	2	2	1	10	1-1/4	3/4	34,000	12
7/8HS & 7/8	1	1-1/8	2-1/4	2-1/4	1-7/32	12-11/16	1-3/8	7/8	46,000	16
1HS & 1, 1-1/4	1-1/4	1-1/4	2-3/4	2-1/2	1-17/32	16-11/16	1-5/8	1-1/8	92,200	32
1-1/4HS - 1-5/8	1-1/2	1-1/2	3-1/4	3	2	18-7/16	1-7/8	1-1/2	153,000	53
1-5/8HS - 2	1-3/4	1-3/4	3-1/2	3-3/8	2-7/16	21-1/4	2-1/8	1-1/2	192,000	77
2-1/8 - 2-1/4 - 2-3/8	2-1/4	2-1/4	4-1/4	4-1/8	2-9/16	25-9/16	2-1/4	1-1/2	220,000	151
2-1/2 - 2-3/4HD**	2-1/2	2-1/2	4-5/8	4-1/2	3-1/8	29-1/2	2-3/4	1-7/8	290,000	195
3HD & 3, 3-1/4	2-3/4	2-3/4	5-1/8	5	3-3/8	32-1/2	3	2	300,000	263
3-3/8 & 3-1/2	3	3	5-1/2	5-1/2	3-7/8	35-3/16	3-3/8	2-1/2	350,000	265
3-1/2HD & 3-3/4	3-1/2	3-1/2	6	6	4-1/2	37-3/4	4-1/4	2-7/8	400,000	285
4-3/4	3-1/2	3-1/2	6	6	5-3/8	46-3/8	4-1/4	2-7/8	450,000	350

Dimensions in inches, weights in pounds.  
 \*HS = High Strength Chain  
 \*\*HD = Heavy Duty Chain

**Table 4-3  
 Pelican Hook Sizing Chart**

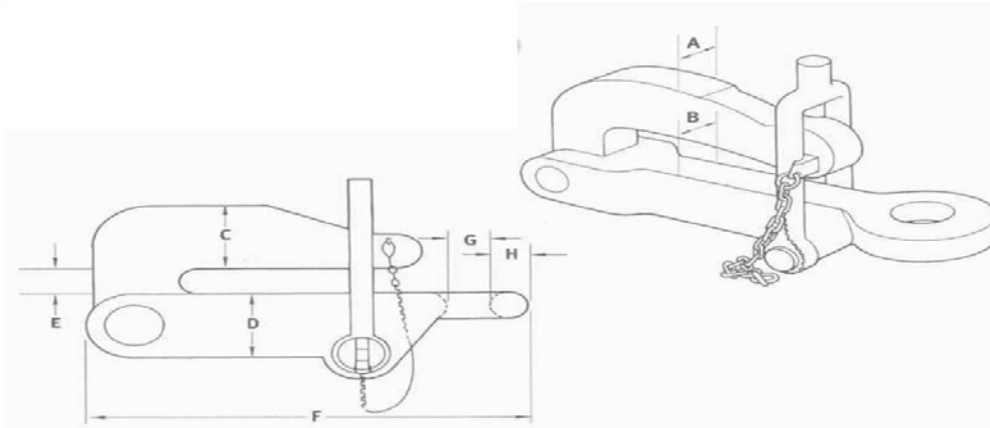

**Figure 4-16**  
**Pelican Hook**

---

**C.6.b.**  
**Positioning**

Position the Pelican Hook to facilitate an individual swinging the sledgehammer inboard to strike the bail. Orienting the pelican hook for an outboard swing may result in the person tripping the bail and being carried overboard by the weight of the sledgehammer.

---

**C.7. Shackles**

Shackles are classified by grade of steel, size, shape, and use. The following are the most common types used in the ATON mission:

---

**C.7.a. Buoy Shackles**

Split Key and Rivet Pin shackles are the two basic types of buoy shackles used by the Coast Guard. These shackles, like buoy chain, are made from mild steel and shall not be used in any rigging application. They are specifically designed to join two sections of chain (rivet pin shackles) and to attach mooring chain to the buoy and sinker (split key).

---

**C.7.b. Rigging Shackles**

Rigging shackles, if used, shall be made of alloy steel. They are available as screw pin anchor or chain type, or anchor or chain bolt pin type. These shackles are designed to handle loads up to their specified WLL without deformation or damage. All alloy shackles shall be fitted with an alloy pin. Shackles used in rigging shall be moused. Shackles and shackle pins shall all be visually inspected prior to use and annually for evidence of cracks or deformation. However, there is no requirement to weight test shackles and shackle pins or to maintain individual records. For this reason any suspect shackles and shackle pins shall be cut to prevent their use and discarded. Shackles and pins are manufactured as a unit and care should be used to ensure that pins are not interchanged between shackles.

---



### C.7.c. Modeer Shackles

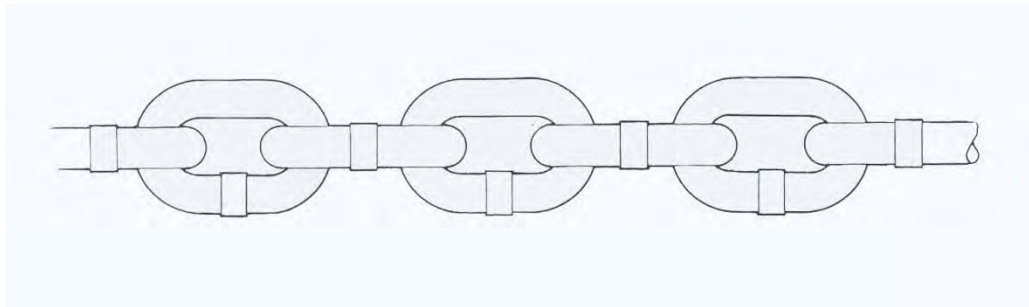

**FIGURE 4-17**  
Modeer Shackle

Modeer shackles are specially designed for the handling of mooring chain. They are narrow, elongated shackles with a removable keyed pin. To use the shackle, remove the pin and slip the shackle over a link of the chain. Keyed into the shackle, the pin gives a positive lock while under strain, but is easily removed when there is no strain. Because of the shackle's narrow shape, the chain cannot slip through it. Modeer Shackles are only available through the national stock system (see **Figure 4-17**). Specific inspection and replacement criteria for shackles are contained in the Aids to Navigation Registry of Lifting Appliances.

### C.8. Chain

Chain is classified by grade of steel, size, shape, and use. It is designed to be loaded in a straight pull. Side loading chain greatly reduces its breaking strength and may damage individual links. Therefore, chain shall never be side loaded. The two most common chain designs used in the Coast Guard are open-link and stud-link (See **Figures 4-18 & 4-19**). The following chain classifications are used in the ATON mission.



**Figure 4-18**  
Open Link Chain



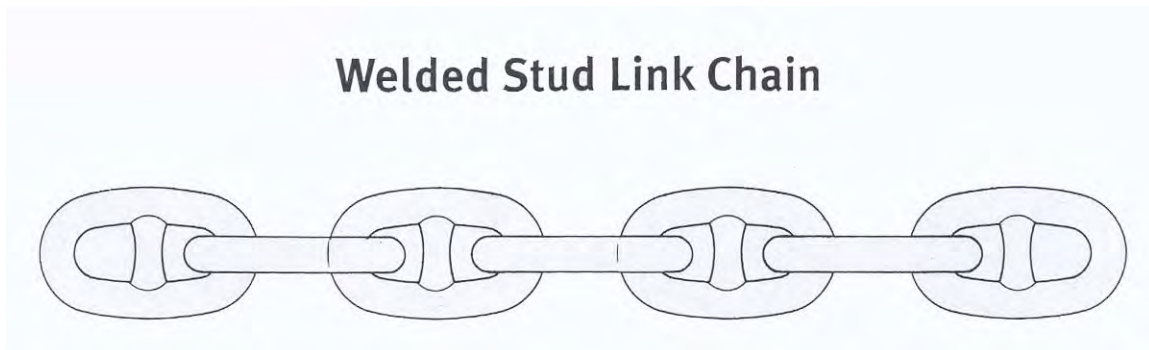

**Figure 4-19**  
**Stud Link Chain**

**C.8.a. Buoy Chain**

Buoy chain (see **Figures 4-18 and 4-20**) is an open link design, made from mild steel and shall not be used in any rigging application. It is specifically designed to moor buoys to sinkers. Inspection and replacement criterion for buoy chain is contained in the Aids to Navigation Manual – Technical, COMDTINST M16500.3 (series).



**Figure 4-20**  
**Buoy Chain Bundles**



**Figure 4-21**  
**Sample Gripe Chain Assemblies**

**C.8.b. Rigging Chains**

Any section of chain used in a rigging application shall be constructed of Grade 8 or better material and shall be proof tested and certified. Specific inspection and replacement criteria for rigging chain are contained in the Aids to Navigation Registry of Lifting Appliances.

**C.8.c. Gripe Chains**

Gripe chains (see **Figure 4-21**) shall be grade 7 or better. Specific inspection and replacement criteria for gripe chain are contained in the Aids to Navigation Registry of Lifting Appliances.



---

**C.9.  
Tag/Steadying  
Lines**

Tag lines are used to steady loads, safely position head blocks and saddles, and vertical hoisting/lowering of tools, minor ATON gear, etc. A tag line consists of a length of synthetic or natural fiber line with a snap hook, shackle, eye splice, or other appropriate end fitting at one end. Tag line components shall be of sufficient size, length, and strength to safely accomplish their intended tasks. Visually inspect tag lines before each use.

---

**C.10. Cage Line**

The cage line is used when bringing a buoy on board the ship and when deploying the buoy over the side. When bringing the buoy on board the cage line(s) is eased allowing the cage to swing inward exposing a lifting bail to be hooked by the crossdeck. Once the buoy is on deck the cage line is used to control the position of the buoy while it is being moved across the deck. When deploying the buoy, the cage line(s) is used to control the position of the buoy while it is being moved across the deck and over the side. Once over the side the cage line(s) is used to position the cage for deploying the buoy and retrieving the hook. This process can be completed using a single or double legged cage line depending on the situation and conditions on scene.

---

**C.10.a. Single  
Cage Line**

The standard single cage line is made up of a length of line sufficient in length for the buoy deck and size buoy being worked. The line has a small eye spliced in one end. A master link is attached to the eye with an appropriately sized shackle. A short length of chain with a snap hook is then attached to the master link using a suitably sized/rated hammer lock (See **figure 4-22**). Stainless steel chain may be used since the cage line is not used for overhead lifting.

When using a single legged cage line for deploying a buoy, a length of double braided nylon line of sufficient length with a small eye spliced in the end is used. The line is run through the cage ring and back to itself using a toggle/fid (see **figure 4-23**).

---

**C.10.b. Double  
Legged Cage  
Line**

The standard double legged cage line is made the same as the single legged cage line, with the addition of a second line attached to the master link.

---



**Figure 4-22**  
**Retrieval Cage Line**



**Figure 4-23**  
**Deployment Cage Line**

### **C.11. Slings**

Slings used aboard ATON vessels are constructed of wire rope, alloy chain, steel mesh, or synthetic fiber. They can either be single/multiple leg construction or of the endless sling variety (sometimes referred to as grommet slings). In some cases the sling legs on single/multiple leg slings are actually endless slings. The design factor for chain slings is 4:1, while the design factor for wire rope and synthetic fiber slings is 5:1. Regardless of the particular type, all slings shall have identification tags permanently affixed to the sling. Specific guidance on the information required on the identification tag as well as inspection and replacement criteria for slings is contained in the Aids to Navigation Registry of Lifting Appliances.

---



### C.11.a. Single/Multiple Leg Slings

Single/Multiple leg slings are made up of several components including but not limited to master link assemblies, sling leg(s), and end fittings (hooks, shackles, etc.). The sling legs are made of wire rope, chain, or synthetic fiber. Chain slings as well as master link assemblies and end fittings on wire rope or fiber slings that are used in overhead lifting operations shall be made of grade 8 or better alloy steel (See **Figure 4-24**). Most slings used on ATON vessels are requisitioned from a competent sling manufacturer where the slings are constructed, proof tested, and certified before delivery. However, if a situation arises when an ATON unit needs to construct a sling, then only new material shall be used, the sling shall be rated to the weakest component at the most adverse sling angle, and the sling shall be proof tested prior to service. Chain slings shall always be constructed of new grade 8 or better alloy chain. When components are added to a manufactured sling (shackles, hooks, etc.) they shall have a WLL equal to or greater than the rated capacity of the sling.

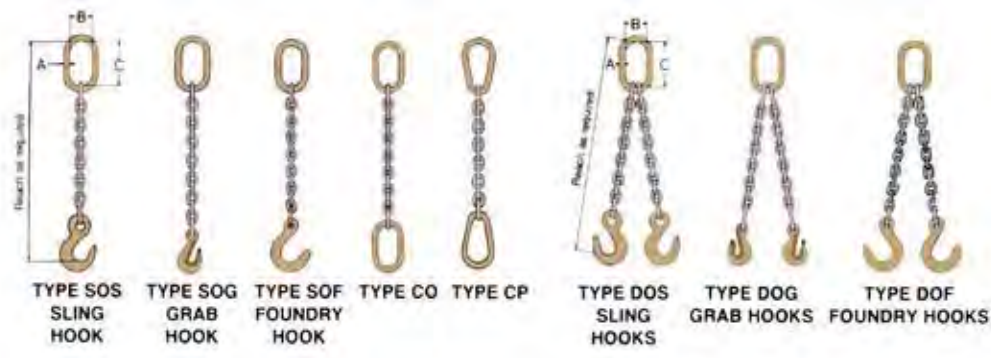

**Figure 4-24**  
Assorted Chain slings

### C.11.b. Endless Slings

Endless slings are typically made of synthetic fiber or wire rope. The most common type of these slings used aboard ATON vessels are round slings, which are constructed of synthetic fiber (for example polyester yarn hank) wound continuously together to form an endless loop. The wound fibers are protected by a polyester tubular sleeve. This type of sling can be used as legs of a single/multiple leg sling, rigged as an open loop (basket hitch) by carrying the sling around the load and putting both loops over the hook, or by slipping one loop through the other (choker hitch), thus making a self-binding sling. These slings are rated for each type of hitch and shall not be repaired or fabricated by Coast Guard units.



**C.11.c. Sling Angle**

It is critical to consider sling angle when choosing and rigging a sling for a particular lift. The sling angle is defined as the angle between the sling legs and the horizon. As this angle is reduced the load on each sling leg is increased (see **Figure 4 - 25**). Sling angles of less than 45 degrees are not recommended, but are often seen on cutter boat slings. **Table 4 - 4** shows the load increase on a double-legged sling, as the angle is increased. To determine the actual load from this table, multiply the weight of the load by the angle factor for the corresponding angle. Your sling will need a WLL equal to or greater than the product. Example: 500 lbs X 1.414 (45 degree angle factor) = 707lbs.

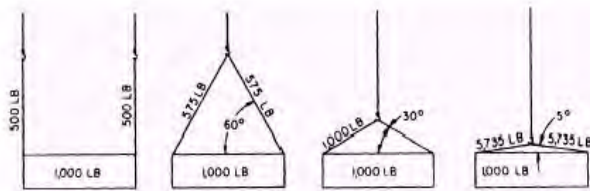

**Figure 4-25**  
**Load Angle Examples**

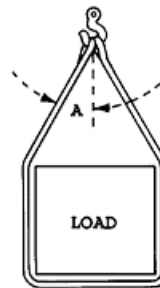

**ACTUAL SLING STRESS**  
**= LOAD X FACTOR**

Angle Degrees	Factor	Angle Degree	Factor
0°	1.000	40°	1.305
5°	1.003	45°	1.414
10°	1.015	50°	1.555
15°	1.035	55°	1.743
20°	1.064	60°	2.000
25°	1.103	65°	2.366
30°	1.154	70°	2.924
35°	1.220	75°	3.863

**Table 4-4**  
**Load Angle Stress Table**

**C.11.d. Sling Safety**

The following are some general safety procedures to follow when employing slings:

- (1) Visually inspect slings prior to each use; damaged slings shall not be used.
  - (2) Slings shall not be loaded in excess of their rated WLL capabilities; taking sling angle into account.
  - (3) Slings shall be rigged to properly balance the load, prevent slippage, and shall be securely attached to the load.
  - (4) Slings shall be padded or otherwise protected from sharp edges or corners of the load.
  - (5) Hands and fingers shall not be placed between the sling and the load, especially when the sling is being tightened around the load. Tag/steadying lines shall be used to steady loads.
  - (6) Avoid shock loading slings – shock loading could cause an overloading situation, which may lead to sling failure.
  - (7) Sling legs shall not be kinked or twisted nor shall they be shortened by knotting or other makeshift devices.
  - (8) Slings shall not be pulled from under a load that is resting on the sling, dragged across the deck or ground, and they shall be stowed in a cool, dark, and dry area.
-



## Section D. Load Securing Equipment

---

<b>Introduction</b>	The proper securing of buoys and other deck cargo is essential to safe and efficient operations. This is accomplished by the use of gripe chains, tensioning devices, web strapping and wooden saddles/blocks. All equipment stowed on deck (buoys, sinkers, chain, etc.) shall be griped down to prevent them from shifting while underway.
<b>D.1. Equipment</b>	This section contains brief descriptions on various load securing equipment that is used on the buoy deck.
<b>D.1.a. Gripe Chain</b>	All gripe chain shall be constructed of grade 7 or higher quality steel and of sufficient lengths/quantities to secure multiple loads. One end of the gripe chain shall have the appropriate style hook (sling or foundry) which is used to secure the chain to the item being secured (buoy, sinker, etc.) on deck. Gripe Chains shall not be used to secure foam buoys.
<b>D.1.b. Ratchet Binders and tensors</b>	Ratchet Binders, which include steamboat jacks and tensors, are used to secure the opposite end of the gripe chain to an attachment point (pad-eye). These binders can be adjusted to remove all slack from the gripe chain preventing any movement of the secured item ( <b>See Figure 4-26 and 4-27</b> ).

---



**Figure 4-26**  
**Ratchet Binder**



**Figure 4-27**  
**Ratchet Binder and Tensor**



**D.1.c.  
Wooden Saddles  
and Head Blocks**

Since most buoys are cylindrical in design, wooden saddles and head-blocks are used to prevent them from rolling on deck when laid on their side. These saddles/head-blocks are made from oak or softwood (i.e. Douglas fir/yellow pine), are typically made locally in a variety of sizes. Tag lines are secured to saddles and head-blocks and shall be a minimum of 10 feet in length, attached to the saddle/head-block with an eye-splice or clip, and have an eye-splice at the other end. Saddles and head blocks may have the tag lines removed when they are not in use. (see **Figure 4-29**).



**Figure 4-28  
Dunnage**



**Figure 4-29  
Saddle and Head Block**

**D.1.d Dunnage**

Dunnage consists of plywood, flat wood stock, or rubber type matting. All flat bottom buoys (i.e. 7X17, 5X11, 5X9, 3 1/2X8), concrete and steel stinkers, and all other miscellaneous deck cargo making direct contact with the steel deck shall have dunnage placed between the cargo and the deck (See **Figure 4-28**). This creates friction between the cargo and deck and lessens the chance that the griped cargo will move in a seaway.

**D.1.e. Synthetic  
Fiber Load  
Binding Straps**

Ratchet tensioning nylon straps can be used to secure foam/plastic buoys but shall not be used on steel hulls larger than a 3<sup>rd</sup> class. Due care and consideration for expected conditions shall be exercised when determining whether or not to use synthetic straps.





**D.2. Procedures** When securing an item on deck there shall be a minimum of two opposing gripes (chain or synthetic strap) that, when combined, shall be able to fully support the total weight of the item being secured. A minimum of two opposing gripes shall be used for unlit buoys, four opposing gripes for lighted buoys, and six opposing gripes for 9X32, 9X35, or larger hulls. The gripes are attached to the item using a hook (sling or foundry) to the appropriate bail on the buoy/sinker. The gripes are then led out at an angle, away from the buoy/sinker and secured to a padeye with a ratchet binder or tensor. Gripes shall be attached to padeyes at angles to prevent fore/aft and side-to-side movement.



This page intentionally left blank.



## Section E. Deck Tools

### Introduction

Aids to navigation related evolutions employ a varied assortment of tools to facilitate safe and efficient operations. Many of these tools are specialized and are used solely for ATON related deck operations, while other tools can be used for various other non-ATON related operations. To ensure safety and efficiency during ATON evolutions, keep all tools in good working order and use the right tool for the job. The following are some of the more common deck tools employed in ATON work. It is not intended to be an exhaustive list of all the tools that might be used aboard vessels for every ATON operation.

### E.1. Line Reeving Device

The Line Reeving Device is used to reeve or pass a line through the lifting bail on a buoy. It is made up of a U-shaped clevis and round spring activated bar usually affixed to an 8 to 12 foot pole. Attached to one end of the bar is a line which is connected at the other end to a sling. The line reeving device works by forcing the round bar through the lifting bale which reeves the line and sling through the bale. The line reeving device is lifted back on deck while still connected to the line that has been reeved through the lifting bale. This line is worked by hand until the sling has been passed through the lifting bale and brought back on deck (see **Figure 4-30**).

### E.2. Chain Hooks

**Chain hooks are made of steel and approximately three feet long with a handle at one end and a hook at the other. The chain hook shall be used by personnel to assist in moving buoy chain 3/4" in diameter and larger on deck to minimize the risk of injury. For smaller chain, best practices, including the use of gloves, should be followed. (See figure 4-31).**

### WARNING

**Handling buoy chain by hand, even while wearing gloves, may result in personnel injury. Additionally, chain under tension should never be handled by hand.**



**Figure 4-30**  
**Line Reeving Device**



**Figure 4-31**  
**Hammers and Chain Hooks**

### E.3. Hammers

There are various styles of hammers and punches used during buoy and construction deck operations. The following are some of the more common varieties.

1. Split Key Hammer (also referred to as a Blacksmith Chisel Hammer) is primarily used to spread shackle split keys. Most split key hammer heads have a flat surface on one end (to be struck by another hammer) while the other end is angled (approx. 20° to 45°) to spread the split key (hammer on left in **figure 4-32**).
2. Drift Pin Hammer is primarily used to drive shackle pins from the shackle clevis. One end is flat (to be struck by another hammer) while the other end is a rounded punch the approximate size of a shackle's pin that is able to punch the pin free of the shackle (second from left in **figure 4-32**).
3. Split Key Punch is primarily used to drive a split key out of the shackle pin slot. One end is flat (to be struck by another hammer) while the other end is small enough to drive a split key through the shackle pin slot when removing.
4. Sledge Hammers are available in various sizes and weights and are used for a variety of purposes aboard ATON vessels. A few examples are tripping a mechanical chain stoppers, pelican hook bails, seating the chain in the chain stopper, forming rivet pins (heat and beats), shackle pins, setting head blocks, etc (see top of **figure 4-31**).



**Figure 4-32**  
Assorted Hammers



**Figure 4-33**  
Assorted Deck Tools

**E.4. Anvil** The Heat and Beat Anvil is used to support two sections of mooring chain and the connecting rivet pin (heat and beat) shackle during installation. These anvils come in a variety of shapes and sizes (see **Figure 4-34**).

**E.5. Swede Wrench** A Swede Wrench is a tool used to keep the pin of a split key shackle from spinning while splitting the shackle key (See **Figure 4-35**).

**E.6 Splitter Bar** Splitter bars are tools used to split the key, they may be used in place of or in conjunction with hammers (See **Figure 4-36**).



**Figure 4-34**  
Anvil



**Figure 4-35**  
Swede Wrench



**Figure 4-36**  
**Splitter Bars**

**E.7 Peavey Hook**

A Peavey Hook is a tool with a thick handle with a hinged iron hook and pointed tip on the end. It's used primarily aboard construction tenders (WLIC) to maneuver wood piles. Peavey hooks without a pointed tip is referred to as a Cant Hook (see **Figure 4-37**).

**E.8 Grapnel Hook**

A Grapnel Hook (Anchor Hawk) is a multi-prong hook ranging in weight from a few pounds to over 400 pounds. The larger hooks (100 to 400 pounds) are employed when dragging for sunken buoys (see **Figure 4-38**).



**Figure 4-37**  
**Cant Hook**



**Figure 4-38**  
**Grapnel Hook**

**E.9 Bull Chain**

The bull chain is a length of grade 8 or better chain that runs fore and aft on the buoy deck used to tie off or "rotten stop" a buoy's mooring chain that is being prepared for deployment from the deck using the staged lift method.



## Chapter 5

# Loading and Unloading Aids to Navigation Gear

---

**Introduction** ATON vessels are required to carry certain gear and cargoes in support of operations. Handling, stowing, and securing this gear can be complicated and requires a thorough knowledge of weight handling safety, rigging, stability, and griping methodology. This Chapter contains safety and rigging considerations for loading and unloading specific ATON gear including buoys, sinkers, batteries, and other associated equipment. WLIC loading and unloading are covered in detail in Chapter 12.B. Additional guidance on this subject is also found in Chapters 4 and 7 of this manual as well as various other Coast Guard manuals, military publications, and texts such as Knight's Modern Seamanship. In addition to loading for specific ATON deployments, vessels carry a standard inventory of ATON equipment that is determined by their area of operation and stowage capacity. Maintaining a standard ATON inventory enables ATON units to respond to unplanned ATON work.

---

**In this chapter** This chapter contains the following sections:

Section	Topic	See Page
A	Planning, Preparation, and Safety	5-3
B	Loading, Unloading, and Securing ATON Equipment	5-5



This page left intentionally blank





## Section A. Planning, Preparation, and Safety

---

**Introduction** Careful planning is required to ensure that a sufficient quantity of ATON associated equipment is loaded to meet the requirements of a particular deployment. On many cutters, the Commanding Officer/Officer in Charge approves the load list prepared and submitted by the Deck Department.

**NOTE**  **Specific ATON work schedules are developed from information extracted from the I-ATONIS database.**

**A.1. Loading Plan** A Loading Plan is developed by the First Lieutenant based on the sequence of ATON work while also accounting for vessel stability. For ATON trips involving long-distances and large deck loads, close coordination between the First Lieutenant and the Engineer Officer is required to prevent problems with vessel stability. Therefore, when developing loading plans, the plan developer should solicit input from the Commanding Officer/Officer in Charge, Engineer Officer, Operations, and Deck Departments

**NOTE**  **Vessel trim and stability considerations are crucial when developing the loading plan. Exercise care when distributing weight on deck and below decks to ensure that the vessel maintains its proper list and trim.**

**A.2. Responsibilities** Prior to any loading or unloading evolution involving weight handling equipment, the First Lieutenant or their designated representative shall:

- a. Ensure that all weight handling and safety gear has been inspected and that any discrepancies are brought to the attention of the Commanding Officer/Officer in Charge and Engineering Officer/Engineering Petty Officer.
- b. Inform the other department heads and the Officer of the Day of the planned operation.
- c. Convene a briefing session to deck department and any other personnel that may be directly involved in the evolution following the applicable sections of Appendix A.
- d. When applicable, energize all appropriate deck equipment. Exercise all applicable weight handling equipment including crane/boom, and deck winches. Obtain permission from the Officer of the Deck prior to



**Figure 5-1  
Padeyes**

- 
- commencing the loading/unloading evolution.
- e. Stage the necessary buoy saddles, head blocks, dunnage, and load securing equipment with due regard for the location of padeyes (See **Figure 5-1**).
  - f. Rig and/or stage all other applicable deck gear and tools.
  - g. Remove the appropriate stanchions and lifelines located in the working buoy port.
  - h. Secure the area from unessential traffic, including the affected pier space.
- 

### **A.3. Safety**

Although most loading and unloading evolutions are conducted while the vessel is moored, these operations are still conducted in a dynamic environment. Therefore, the applicable safety procedures contained in Chapter 3 of this Manual and the Cutter Organization Manual (COMDTINST M5400.16 (series)) shall be observed. In addition the following general safety precautions shall be observed while handling loads:

- a. Only authorized personnel shall be allowed in the vicinity of the loading areas during operations.
  - b. Standard crane hand signals (shown in Appendix B) shall be used when ever conducting weight handling operations.
  - c. Ensure that all weight handling gear is properly sized for the load, pay particular attention to sling angles.
  - d. Ensure that tag/tending lines are properly attached to all loads and positive control is maintained at all times.
  - e. Keep the deck and other work areas clear of stray lines, loose tools, and other gear. Pay particular attention to the load's intended landing area.
  - f. Ensure that each load on deck is secured sufficiently before continuing with load/unloading operations.
  - g. While pier side deck loading and unloading evolutions provide great hands-on training opportunities for unqualified personnel, it is imperative that qualified personnel are available and closely supervising break-in personnel under their instruction during these evolutions.
-



## Section B. Loading, Unloading, and Securing ATON Equipment

**Introduction** The safe and efficient movement of ATON equipment from pier to ship, from ship to pier or when restaging the deck while underway is a critical component for successful ATON operations. In addition, safely and effectively securing buoys, sinkers, and other equipment on the cutter or boat to prevent any ATON gear from shifting on deck while underway shall be a top priority for ship's force and command personnel.

**B.1. Loading Buoys** Most buoys are better handled by using a two-legged sling, as these slings will balance the buoy at a better angle for setting it in a saddle (See **Figure 4-23**) or on dunnage for a flat bottom buoy.

**CAUTION !** **Increased sling angles decrease the sling's WLL. Chapter 4 of this manual and other approved rigging publications provide specific information on this subject**

**B.1.a. Taglines** A minimum of two taglines shall be used when loading or unloading larger lighted buoys. One tagline (the headline) is passed through the lantern guard ring and the second tagline (the tail line) is attached near the buoy's counterweight. Personnel on the dock/deck tend these lines to help maintain positive control the buoy. As the buoy is being moved from one location to another it may be necessary to pass the tagline, during this transfer positive control must be maintained, therefore only one tagline should be passed at a time

**B.2. ATON Equipment** This section describes some of the hardware that is used in the ATON mission. Further explanations and details are available in the Aids to Navigation Manual – Technical, COMDTINST M16500.3 (series)

**B.2.a. Sinkers** Sinkers are loaded by hooking the appropriate purchase, pennant, or sling directly into the bail of the sinker. Larger tag/tending lines and/or crossdeck wires are typically used to steady sinkers when being moved from one location to another.

**B.2.b. Chain and bridle** Chain and bridles are typically loaded and unloaded in bundles of one or more shots/pieces. Appropriate load rated straps shall be used to bundle and hoist chain and bridles.



**CAUTION !**

**New chain and bridles are typically shipped from the manufacturer in bundles of one or more shots/pieces. The factory installed wire or wire rope strap is not load rated and therefore shall not be used for hoisting.**

**B.2.c.  
Batteries**

Solar ATON batteries contain sulfuric acid, which is extremely corrosive, and produce hydrogen gas, which is explosive. Therefore, ensure that the battery casings are intact before transporting and that the storage areas are well ventilated.

**WARNING** 🖐️

**Appropriate Personal Protective Equipment (PPE) SHALL BE worn whenever handling ATON batteries. This PPE includes: rubber gloves, a rubber apron, a full face shield and splash proof goggles.**

**CAUTION !**

**A load rated pallet sling shall be used when moving batteries secured on a pallet.**

**B.3.  
Fundamentals  
of Stowage**

Buoys and other aids to navigation equipment come in a variety of sizes, shapes, and weights, each presenting different stowage and deck securing challenges. The following practices are provided to assist with these challenges:

- a. Use a sufficient numbers of gripes of ample size and lead, i.e. in opposing directions, to prevent movement. While underway, gripes must be inspected regularly to insure no change in tautness or shifting of the load has occurred. The movement of the ship, especially when sea conditions cause a lot of green water to come onto the buoy decks, can cause gripes to become loose therefore they require strict attention by watch standers. While underway, it is recommended that gripes be checked by the relieving watch to ensure that there are no problems with the deck load.
- b. Leave sufficient room on deck for working personnel and equipment; never overload the buoy deck or storage hold.
- c. Always block and gripe buoys and other equipment, even in calm seas and fair weather. Gripe loads to the deck as they are loaded; do not wait until everything is loaded aboard before griping.
- d. Dunnage shall be used for all ATON equipment stowed above/below deck.
- e. Stow buoys and other equipment so that they are clear of bitts, cleats, scuppers, and other deck fittings. Consideration must also be given to not block access to scuttles and hatches or emergency escape routes that may be required for damage control events.



- f. Use a sling with a sufficient WLL and length to connect the hoisting purchase to the load when handling loads below deck. This practice will keep the hoisting purchase above the hatch combing reducing the chances of it hooking a fitting within the hold or the hatch combing. A block and tackle or ratchet lever hoist (come-along) may be used to position loads, (buoys and other equipment) in stowage holds

**NOTE** 

**Small line shall not be used in place of appropriate load handling or securing equipment.**

**B.4. Buoy Stowage**

Lighted tube buoys and most unlighted buoys, i.e. buoys that lay on their side when stowed – 8X26, 6X20LRs, 1CR, etc, are placed in special wooden saddles with the upper buoy body supported on a headblock prior to griping them to the deck. Lighted buoys that are stowed in the upright position, i.e. 7X17, 5X11LRs, are placed on wooden dunnage prior to griping them to the deck. In any case, buoys shall not rest directly on a steel deck without the appropriate buoy saddle and/or dunnage. Using the proper dunnage for stowing buoys will create friction, which helps to keep the buoy from sliding on deck. However, dunnage alone is not sufficient for securing buoys on deck, so therefore all buoys and equipment shall be properly griped to the deck or below decks.

**B.4.a. Griping Hardware**

The approved griping system aboard Coast Guard vessels shall consist of Grade 7 or better alloy chain put under tension with ratchet binders or tensors or synthetic nylon straps. More information concerning gripe gear components is contained in Chapter 4 of this manual.

**B.4.b. Griping Procedure**

Lighted steel buoys shall be secured to the deck with a **minimum** of four (4) separate gripes – two controlling the tube or counterweight section and two controlling the head of the buoy. Unlighted buoys (third class and below) do not always have sufficient griping points (i.e. lifting/mooring bails) to comply with this requirement. In these cases a minimum number of two gripes, chain or synthetic straps (for short durations), shall be rigged to ensure that the buoy does not move.

**B.4.c. Larger Buoys**

Because of their size and weight, larger buoys (9X35LRs, NOAA buoys, etc.) require more than four (4) separate gripes. Nine foot buoys shall be secured with a **minimum** of six (6) separate gripes: two controlling the tube and four controlling the head (referred to as the upper and lower head gripes). NOAA buoys, depending on the specific type being carried, have unique griping requirements. Consultation with the embarked NDBC technicians is important for properly griping NOAA buoys.



**B.4.d. Non – Standard Buoys**

NOAA buoys, non-Coast Guard, and other non-standard buoys often present unique challenges that require a certain degree of innovation to effectively secure them to the deck. Although no set of procedures can cover all eventualities, the following certain basic considerations apply in all cases:

- (1) Ensure that each gripe employed has a WLL equal or greater than the item being secured.
- (2) Use the sufficient number of gripes (minimum of 4) to keep the griped object from moving.
- (3) Ensure that each gripe is counteracted by a different gripe.

**B.4.e. Synthetic Lines and Straps**

Synthetic lines and straps may be used to secure small lightweight foam and plastic buoys (5X9 and below). Use the same griping principles employed when griping larger buoys. Synthetic strap type gripes are authorized on 3<sup>rd</sup> class and smaller steel hulls for short transits and while being serviced only. Extended transits (i.e. overnight) and foul weather require the use of chain gripes.

**NOTE** ~

**Synthetic lines and straps shall not be used to gripe larger steel buoys. Synthetic straps may only be used on 3<sup>rd</sup> class and smaller steel buoys or foam buoys 5x9 and below. Ensure that the WLL of these synthetic straps are sufficient for the job. The rule of thumb is one gripe should be able to safely support the weight of the griped buoy.**

**NOTE** ~

**The elastic characteristic of synthetic materials may allow the load to shift despite the original tautness of the gripe. The stretch of the synthetic material allows movement and the shock load of a moving object can easily exceed the breaking strength of the gripe. Therefore, check synthetic straps and all gripes often; it is much simpler and safer to check and tighten gripes on a piece of equipment rather than try to secure it once it's loose in a seaway. When in doubt, add chain gripes.**



## Chapter 6

# ATON Operations in Ice

---

**Introduction**

The methods suggested in this chapter are techniques that have been employed successfully by others. Because every situation cannot be covered in this text, ensure a deliberate risk assessment is conducted; discuss all identified hazards and mitigating strategies prior to the evolution. Thoughtful innovation is encouraged and the methods described in this section have worked well in the past.

---

**In this chapter**

This chapter contains the following sections:

Section	Topic	See Page
A	ATON Operations in Ice	6-3

---



This page left intentionally blank





## Section A. ATON Operations in Ice

---

- Introduction** Some buoy tenders will be required to service buoys in ice conditions. The manner in which the buoy is worked will depend on variables such as type and thickness of the ice, **proximity** of shoal water, and speed and direction of ice movement.
- 
- A.1. Considerations** Always try to use ice and wind conditions to your advantage. Never approach a buoy in ice without maintaining a good plot of the location of both the tender and the buoy. Reference points are often obscured or unreliable because of poor visibility. Distance and speed of advance are more difficult to determine in moving ice.
- 
- A.1.a. Patience** Never rush an evolution; there are too many accidents that can happen when people are working on a cold slippery buoy deck. If one plan isn't working, it is advisable to stop, allow the crew to warm up, and develop a new plan.
- 
- A.1.b. Precautions** Precautions should be taken to minimize danger to the crew. Ensure that personnel on deck are adequately clothed and equipped with proper PPE. Sending a person out on the ice should be only a last resort. If you must send someone out, ensure that the person is wearing a **properly outfitted dry suit with appropriate thermal protective layers** or a survival suit and that the person is attached to a life line and carrying a boat hook. The boat hook is used to probe the ice for weak spots, or is carried horizontally to break a fall should the person go through the ice.
- 
- A.1.c. Remove the Ice** When working a buoy with significant ice growth, always remove as much ice as possible from the buoy before bringing it on deck. Often, a buoy in otherwise open water will have a collar of ice at the waterline. Removing this ice while the buoy is outboard of the buoy port allows you to maintain better control of the buoy. It also prevents damage to the main purchase from exceeding the weight limit and reduces the chance of a crewman being injured by falling ice or by slipping on deck.
-



### A.1.d. Methods of Ice Removal

Several methods have been tried over the years to remove ice from buoys. Generally any method that causes the buoy hull to vibrate without damaging the buoy or endangering personnel will be effective. The vibration of the metal breaks the ice away from the buoy hull. Blacksmith hammers, sledge hammers, pry bars, and air hammers have all been used effectively. Shotguns with 00 buck shot work well for clearing **bails** as does low pressure hot water from a garden hose.

### WARNING

Do not attempt to lift a buoy by the cage. Buoy cages were never designed for lifting a buoy. Keep in mind that there may be several tons of accumulated ice on the buoy. It is not unusual for ice-covered buoys to hang horizontal when lifted out of the water.

### A.2. Working in Ice

Buoy tending in pancake, skim, or fast ice, less than four inches thick, is the same as buoy tending in open water since buoys in ice of this type are usually visible.

#### A.2.a. The Approach

When working a buoy in fast ice, in excess of four inches, approach the buoy as close as possible. This will prevent ice from getting between the vessel and the buoy and forcing the buoy too far away to be hooked. This **may require driving directly on or toward the buoy and could result in contact with the buoy forward of the buoy port.** Use only enough power to bring the buoy abeam the ship at the buoy port. This way you can use the ice to stop your forward movement and maintain station while working the buoy. The buoy may be on its side but still visible above the surface. If the buoy is heavily iced, it may be necessary to clear the lifting bail with a shotgun or hot water from a low pressure garden hose.

#### A.2.b. Locating a Buoy Under the Ice

A buoy that has been forced under the ice can be located by relieving the pressure around the buoy, allowing the buoy to surface. In **large plate or fast ice**, it may be necessary to **cut relief tracks.** Determining what the wind direction was several days before **may** give you an indication as to which direction the buoy and chain **are** led. **Creating reliefs in the ice may help surface the buoy and** minimize chances of wrapping a buoy in the screw. Buoys often leave a trail of broken ice as they force their way to the surface. This trail is very useful in finding buoys that have been dragged from AP. **If it is believed the sinker is on AP,** keep the stern of the vessel well clear of the estimated watch circle. If unable to cut relief tracks due to shoaling, station a person on the forecastle with a marker. If the buoy is driven under during the approach, toss the marker over at the bow. This will give the conning officer an idea of his/her speed in relation to the ice and help prevent



---

overriding the buoy. Once a buoy has been brought alongside, maneuver the vessel so moving ice is forced around the bow and just clears the buoy. Take care to not get canted so far that the ice sets the ship onto the buoy and mooring. The unequal pressures present in ice make it nearly impossible to keep station with anything other than the bow facing into a moving ice field. A pass by the buoy position may also crack the ice and allow the buoy to surface.

Once the location of one buoy has been obtained, it is likely that other buoys in the area may be set the same direction and distance from their respective AP.

---

### **A.3. A Buoy Alongside In Moving Ice**

Because of the deceptive nature of a moving ice field, it can present one of the most challenging buoy evolutions. The ice is usually of varying thicknesses and consistencies, which will introduce variable forces to your station keeping problem in the same manner as a gusting wind. The tender can actually be set away, onto, or worse, overshoot the approach on a buoy that has gone under the ice. Since the ice and the tender are constantly moving, if the buoy is forced under the ice it will be almost impossible to gauge the tender's movement or location in relation to the buoy. A natural range works well, but may not be available. The best way to approach this situation is to determine the direction the flow is coming from. If there is sufficient sea room for maneuvering, break a track from the buoy into the flow. This way the buoy will surface in a broken track and will be visible during the approach. You will find it necessary to maintain turns in a moving ice field in the same manner as stemming a current. The critical part of the evolution is to lift the buoy hull clear of the ice before the unbroken ice field reaches the buoy. Depending on the ice field's speed of advance and the icing on the **bails**, this evolution may have to be repeated several times.

---

#### **A.3.a. Clearing the Lifting Bail**

Sometimes a boat hook, low pressure hot water from a garden hose, large shackle on a heaving line, or shotgun with 00 buck will clear the lifting **bail**. It may even be necessary to swing a small sinker from the main to knock ice loose. In the worst cases, ramming the buoy may be required to clear enough ice so you can hook the buoy. This procedure is described in detail later. After the buoy is hooked, get the chain into the stopper as quickly as possible. Moving ice will break around the chain and you can effectively stem a flow while lifting the sinker. Again, you should always maintain a constant plot of your position in moving ice.

---



### A.3.b. Clearing Ice from a Buoy by Ramming

Heavy ice accumulation may force the tender to remove ice by ramming the buoy with the bow. During the execution of this evolution, use only enough speed to make contact with the buoy. At the time of impact the tender should be backing to prevent overriding or striking the buoy so hard as to cause damage to the cage. Under no circumstances should so much speed be used that the buoy advances past the buoy port. It will be necessary to place a person on the forecastle to call distances and directions for the conning officer. Buoys have a tendency to "walk" away from the bow of a cutter, and course corrections may be necessary.

### NOTE

**Because of the potential for serious damage to the buoy hull, ramming should be used only to remove ice in excess of 24 inches.**

### A.4. Towing Buoys in Ice

It may be necessary to drag the buoy to safer water before attempting further retrieval efforts. Towing a buoy in ice is very dangerous and should be executed only after everyone involved understands the evolution. Towing a buoy away from a shoal because of prevailing ice movement may be necessary to prevent hazard to the vessel. Because of the dangerous nature of this evolution, it should be considered only when faced with the possible loss of the buoy hull. It is much cheaper to replace a lost buoy than to replace hull plate.

#### A.4.a. Procedure

Buoys should be towed by a line attached to a bail. The buoy should never be towed while hooked into the main purchase. Instead, the line should be passed through the chock forward of the chain stopper and attached **to bitts on the foc'sle**. Enough slack should be left in the towline to allow the buoy to slip into the track left by the vessel as it backs away from the shoal. Another method of towing a buoy is to use a large round sling attached to the lifting bail and secured to the pelican hook on deck. There may be an initial hesitation if the sinker is well mudded in.

### WARNING

**There is great potential for parting the towline on a stubborn mooring. All personnel must be kept well clear of the towline when towing a buoy in ice.**



### **A.5 Sinkers on Ice Buoys**

---

Experience has shown that lifting the sinker during a fall seasonal relief may increase the odds that the seasonal ice buoy may go off station during periods of heavy moving ice. It is therefore recommended not to lift the sinker until the spring relief season. This will give the sinker six to eight months before the next ice season to firmly settle itself into the bottom. This recommendation only applies to softer bottom types such as sand or mud.

---



## Chapter 7 General Stability

---

### Introduction

Coast Guard ATON vessels often carry considerable deck loads. Good planning and close adherence to cutter loading principles contained in cutter-specific Stability and Loading Data Booklets (SLDB), or Damage Control Section Part II(a) (for WLBB 30), and verified by Flooding and Casualty Control Software (FCCS) can ensure cutters are loaded properly and remain within a safe range of list and trim, especially during dynamic ATON operations. This chapter is not intended to provide all-inclusive guidance on stability but rather is intended to highlight basic stability information and principles. It is vitally important for Commanding Officers/Officers in Charge, Engineering Officers/Engineering Petty Officers and First Lieutenants work cooperatively to become familiar with the fundamentals of cutter stability. General vessel stability information is also available in the Naval Ships' Technical Manual, Chapter 079, Volume I.

---

This chapter contains the following sections:

Section	Topic	See Page
A	Stability	7-3
B	Stability and Loading Data Booklet (SLDB)	7-7
C	Corrective Procedures	7-15
D	Flooding and Casualty Control Software	7-17



This page left intentionally blank



## Section A. Stability

**Introduction** Stability is the measure of a cutter's ability to return to its original position when it is disturbed by a force and the force is removed. A cutter may have one of two types of stability:

If the cutter returns to its original position after being disturbed by an external force, it is stable, and has **positive stability**.

If the cutter continues in the same direction of the external force after the force is removed, it is unstable, and has **negative stability**.

The following definitions are key terms in understanding stability and how cutters react to various loading conditions and situations.

**NOTE** 

**Operators with any questions about stability and/or their vessel's stability guidance should contact the USCG Surface Forces Logistics Center, Naval Architecture Branch (SFLC-023), phone (410) 762-6708.**

### A.1. Buoyancy

To understand the principles governing stability one must first understand the principle of buoyancy. When a cutter is placed in water, it displaces a volume of water equal to the weight of the cutter. The displaced water exerts a pressure on the hull, forcing the cutter back out of the water. This upward force is buoyancy. The resultant buoyant force acts in a vertical line through the center portion of the cutter's body. This point is called the center of buoyancy and is designated by the letter B in Figure 7-1. Buoyancy is a function of the cutter's underwater body shape and volume.

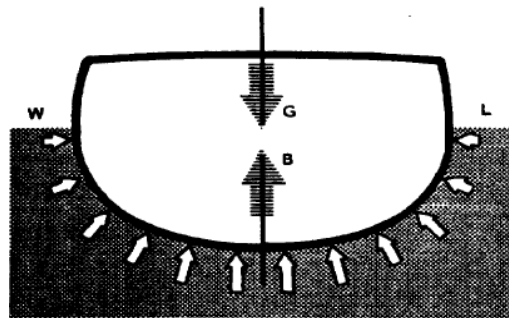

**Figure 7-1**  
Centers of Buoyancy and Gravity

### A.2. Center of Gravity

Countering the force of buoyancy is the weight of the cutter and its cargo. Though the weight of the cutter is distributed throughout the cutter, it is considered as acting through a single point. The point through which this resultant force acts is called the "center of gravity" and is designated by the





---

letter „G“. The weight of the cutter acts in vertical line in a downward direction (See **Figure 7-1**). The center of gravity of a cutter is solely a function of the cutter’s weight distribution. It changes whenever there is a weight added to, removed from or relocated on the cutter.

---

**A.3.  
Equilibrium**

With no external forces, such as beam winds, a cutter remains in equilibrium with the force of gravity acting downward and the force buoyancy counteracting each other through the same vertical line. The application of an external force causes the cutter to heel and will also cause the centers of buoyancy and gravity to no longer be vertically aligned. This creates a righting moment which is attempts to move the center of gravity and center of buoyancy back into alignment. The „strength“ of the righting moment is the equal to the displacement of the cutter times the distance between the parallel lines of force passing through the centers of gravity (G) and buoyancy (B). That distance, GZ (see Figure 7-2), is called the “righting arm”. If the external force continues to act on the cutter, the cutter will reach a new position of equilibrium at the point where the righting and heeling moments are equal. The Original Waterline is marked by „W-L“, the waterline after force is applied is  $W_1 - L_1$ , and CL is the original centerline. A good example of the point where the righting moment and heeling moment are equal is the angle of heel a buoy tender experiences while hooking into an aid being serviced.

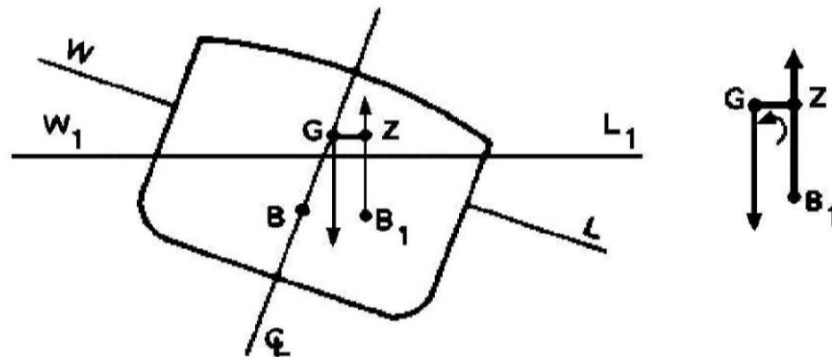

**Figure 7-2  
Waterline, Righting Moment Present, Cutter Incline**

**A.4.  
Metacentric  
Height**

---

The metacentric height, GM, is the distance between the center of gravity (G) and a point called the metacenter (M). The metacenter is an imaginary point that is of prime importance in stability. When a cutter is inclined small angles, the intersection of the line buoyant force acting vertically through the new center of buoyancy and the inclined centerline of the cutter is the metacenter. For any angle of heel, GM is proportional to the righting arm, GZ. When M is located above G, GM is positive and a righting moment exists (**Figure 7-3a**).

---



In those cases where the position of G is located above M, GM is negative and an upsetting arm develops (**Figure 7-3b**). Thus, GM is an indicator of whether a cutter's initial stability is positive or negative.

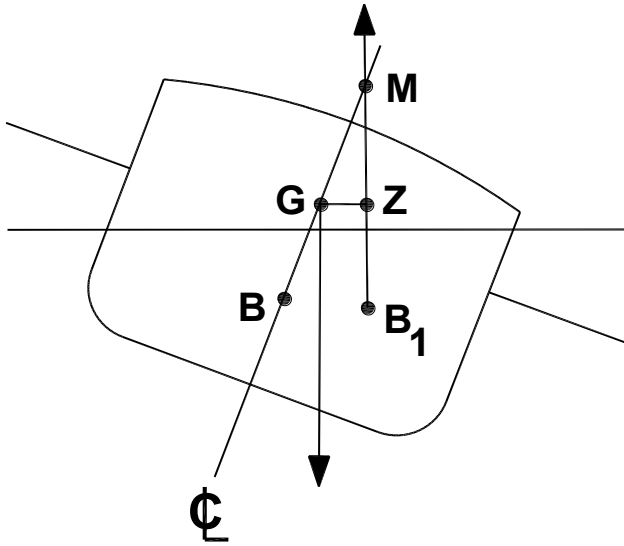

**Figure 7-3a**  
Vessel in stable condition

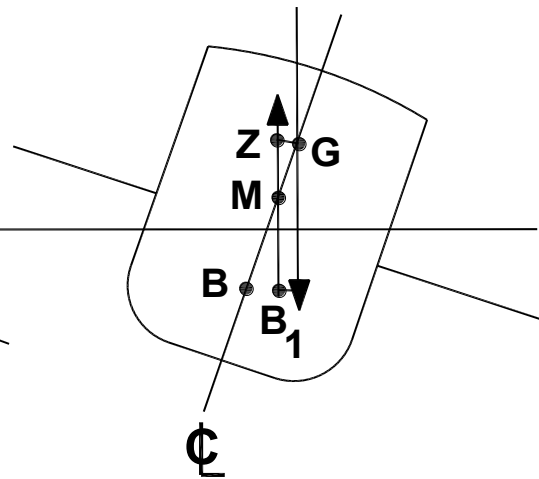

**Figure 7-3b**  
Vessel in unstable condition

GM Indicating Initial Stability, Positive/Negative



This page intentionally left blank



## Section B. Stability and Loading Data Booklet

---

### Introduction

A Stability and Loading Data Booklet (SLDB) has been developed for most ATON vessels; except for the WLBB-30 whose stability guidance is provided in the WLBB Damage Control Book, Part II (a). The purpose of the SLDB (or Part II(a)) is to assist operating personnel in the control of loading and operating the cutter, in maintaining the cutter within the safe range of cutter stability for both normal (intact) and damaged conditions, and to provide guidance for appropriate action after damage. Commanding Officers shall familiarize themselves with the stability guidance in their vessel's SLDB (or Part II (a)).

### NOTE

**Commanding Officers/Officers in Charge shall be thoroughly familiar with the stability practices onboard their cutter. Any specific questions about their vessel stability information should be referred to SFLC-023, phone (410) 762-6708.**

### B.1. Limiting KGv Curves

The height of the virtual center of gravity (KGv) is one of the most important measures of vessel stability. KGv is equal to the cutter's vertical center of gravity plus the correction due to the free surface effects of liquids plus a 0.2 foot safety factor to account for inaccuracies during the inclining experiment. As a cutter's KGv becomes higher, the cutter becomes less stable and will heel to greater angles when acted on by external forces. The maximum allowed height (a.k.a. the limiting height) of each vessel's KGv, for the intact cutter to be able to withstand disturbing influences (such as a beam wind), and for the damaged cutter to be capable of withstanding assumed cases of flooding has been determined for a range of displacements. The limits are presented on "Limiting KGv Curves", which are included in each SLDB (or Part II (a)). Commanding Officers/Officers in Charge, with the assistance of their Engineer Officer/Engineering Petty Officer, must always know their cutter loading condition and KGv values so that the KGv limits are not exceeded. A typical Limiting KGv Curve is shown in **Figure 7-4**.

---

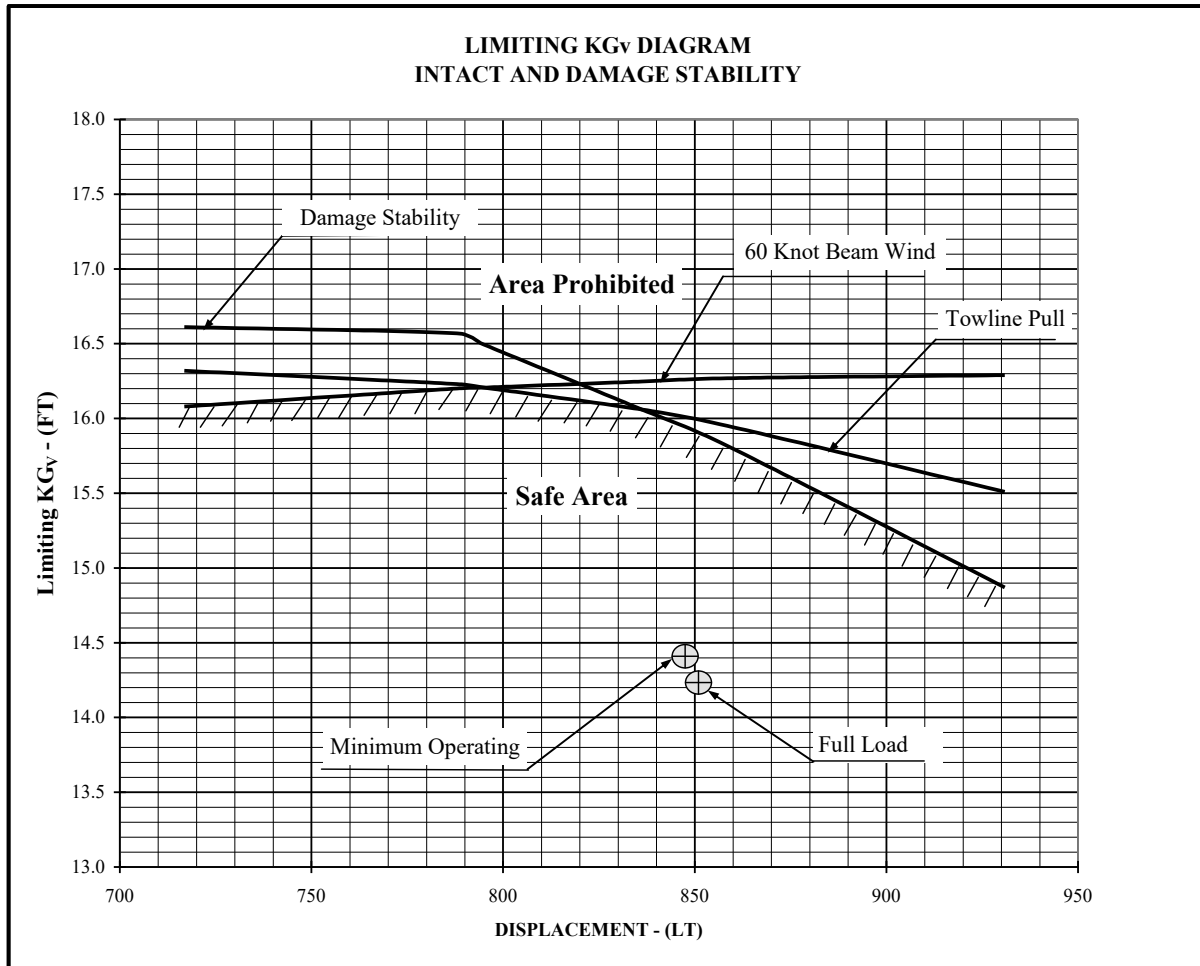

Figure 7-4  
Limiting KGv Diagram

**B.2. Draft and Trim**

Draft and trim have considerable bearing on cutter stability. A change in mean draft will affect the height of the metacenter, thus altering GM; and both draft and trim affect the cutter's reserve buoyancy. The maximum allowed drafts and the range of acceptable trim is identified in each vessel's SLDB (or Part II (a)).

**B.3. Lifting Capacity Curves**

The appropriate guidance for lifting operations is provided in each ATON cutter's SLDB (or Part II (a)). For the WLMs and WLBs the guidance also includes lifting capacity curves. The maximum loads that can be safely lifted can be determined from the curves. FCCS can also be used to test lifting various buoy hulls under different loading conditions. Commanding Officers/Officers In Charge should fully understand and adhere to this



---

guidance. Do not assume that it is always safe to lift any load less than the boom's maximum capacity. A cutter's loading condition, sea state, roll period, presence of beam winds, and other factors will have an impact on what loads may be lifted safely without causing excessive heel or having an adverse effect on the cutter's reserve stability and righting arm.

---

#### **B.4. Liquid Loading Instructions**

Operators must follow the liquid loading instructions provided in each ATON vessel's SLDB (or Part II (a)). The liquid loading instructions prescribe a tank sequence for using fuel and adding ballast that will help maintain the KGv and trim within allowed limits. All cutters should make efforts to minimize free surface effects in tanks, especially slack tanks (tanks that are not pressed full). Unless otherwise specified in cutter specific instructions, ballasted tanks must be pressed full to reduce free surface effect. For WLBs ballast tanks 4-21-0-W, 4-48-0-W, or 4-57-0-W are especially critical and must be pressed full when ballasted due to their very large free surface effects. Ballasting and de-ballasting of these tanks must be done one at a time and in the shortest time possible.

---

#### **B.5. Load Conditions**

The SLDB (or Part II (a)) depicts a cutter's standard loading conditions, which typically include when it is fully loaded (Full Load Condition) and a minimum load condition that corresponds to when the cutter returns to port at the end of a mission (Minimum Operating Condition). Also presented are conditions for a typical ATON lift, and a lift with maximum boom or crane reach. Commanding Officers should be familiar with their cutter's Minimum Operating and Full Load Conditions, which are presented in tabular form in the SLDB. The liquid loading of the Minimum Operating Condition are a result of the liquid loading instructions.

---

#### **B.6. Trim Table**

Predicting changes in trim due to adding, deleting, or shifting weight onboard a cutter is done by using the SLDB's Trim Table. The table consists of a simplified profile view of the cutter with a graph below the various compartments that indicates how much a standard weight placed in that space will affect draft. For example, in **Figure 7-5** shows that if a 175' WLM loaded 2.5 tons into the forward hold, the draft change would be determined as follows:

The Trim Table shows that a 5-ton addition to the forward hold at Frame 28 would increase draft forward by 1.2 inches and decrease draft aft by 0.2 inches. Since the weight in the example is one half of the standard 5-ton weight, the change in drafts will be one half of the charted change, or an increase of 0.6 inches forward, and a decrease of 0.1 inches aft. The trim between the draft marks will change by 0.7 inches down by the bow.

---

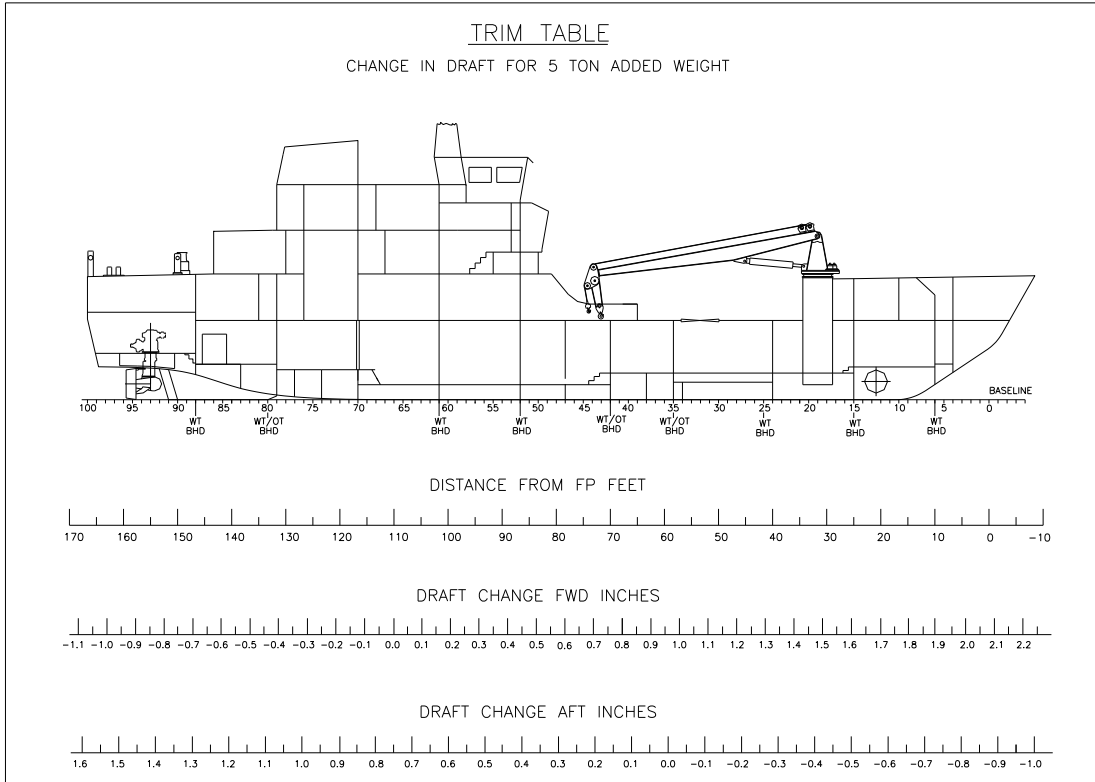
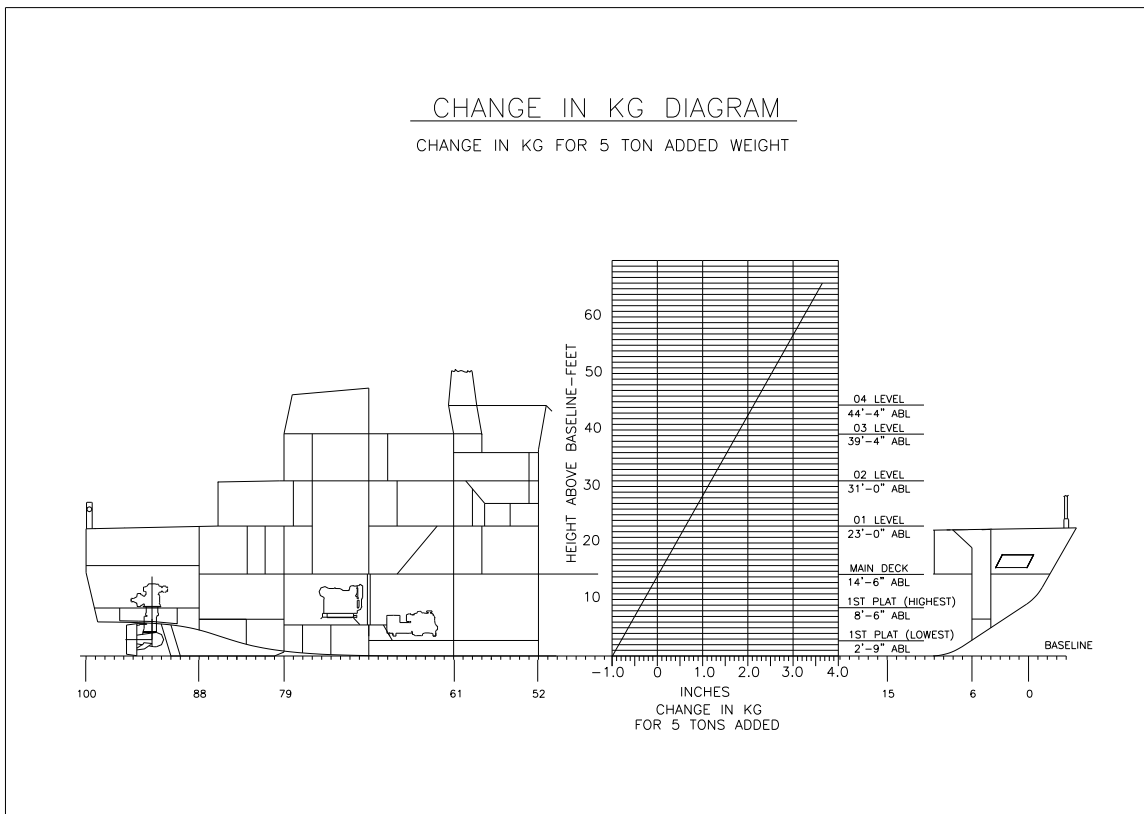

**Figure 7-5**  
**Trim Table**



**B.7. Change in KG Diagram**

The Change in KG Diagram (**Figure 7-6**) is used to determine the effect on KG of adding (or removing) a weight at any height. Although the graph was developed using a weight of 5 LT, it is applicable to any weight. To use this diagram, locate the vertical center of gravity (VCG) of the added weight on the cutter profile, move horizontally across the point of intersect with the appropriate load condition line. Move vertically down and read the change in KG for a 5 LT added weight. Then, multiply the change in KG by the ratio of the actual weight added over 5 LT. Add this value to the cutter KG to find the new KG. For weight removed, reverse the sign of the change in KG.



**Figure 7-6**  
**Change in KG Diagram**





---

**B.8. Grounding** The mission of ATON vessels sometimes places them at risk of running aground. In the event of a grounding:

- a. Flooding boundaries should be established and determine the extent of damage. The decision whether or not to remove the cutter from the obstruction should be made based on a full assessment of the damage, estimate of the cutter's tons aground, predicted weather and tides, and a prediction of the cutter's stability after floating free.
- b. Attempts to remove the cutter from the obstruction should not be made if the wind and sea conditions indicate the possibility of the cutter working harder aground, pounding, or broaching to sea. If an attempt is made to back down and the reversing propellers have no immediate effect, the backing operation should cease immediately. Any further attempts to remove the cutter from the grounding should be made with the aid of one or more tugboats, or by using ground tackle and anchors.
- c. If no attempt to back off is made, the cutter should be weighed down immediately by filling the ballast tanks. This action is necessary to keep the cutter from working and pounding on the bottom.
- d. Anchors should be laid to seaward as soon as possible to prevent the cutter from working itself harder aground.
- e. The surrounding waters should be sounded to determine the slope and nature of the bottom.
- f. If the vessel is aground on either the bow or the stern, weight should be shifted to the end of the vessel that is aground to ease the resulting sagging condition. If the vessel is aground near amidships, weight should be shifted toward the middle of the cutter to ease the resulting hogging condition.

To assess the cutter's stability while grounded, the displacement should be calculated based on the draft marks. The difference in displacement before and after grounding is the upward grounding force. This force is entered as a negative weight at the base line on the SLDB (or Part II(a)) displacement worksheets to calculate the stability of the cutter in the grounded condition.

The FCCS Program can also be used to assess the cutter's stability when grounded, and to compute the theoretical bollard pull necessary to pull the vessel free, and/or to determine if the tidal shift will be sufficient to free the vessel.

---



---

**B.9. Procedures After Damage**

A key component to the cutter surviving damage depends on following the liquid loading instructions, maintaining acceptable KGv, draft, and trim before damage, and following the “Procedures After Damage” that are presented in the SLDB (or Part II(a)).

There are two major actions that cutter’s personnel must keep in mind that will greatly improve the chances of survival in case of damage:

- a. The cutter must maintain watertight integrity; and
- b. Familiarity with the requirements and procedures of the SLDB (or Part II(a)) and its use under normal and emergency conditions.

---

**B.10. Initial Action After Damage**

The initial steps to be taken whenever flooding occurs are to

- a. Close openings to prevent progressive flooding,
- b. Establish flooding boundaries as close to the area of damage as possible, and
- c. Size up the situation to determine whether stability is critical before taking further action.

The SLDB (or Part II(a)) provides guidance on how to determine when stability is critical, plus remedial steps for various situations. Commanding Officers should be thoroughly familiar with the guidance.

---



This page left intentionally blank



## Section C. Corrective Procedures

---

### Introduction

This section covers the signs and symptoms of a vessel suffering from reduced stability and some recommendations to reduce the likelihood capsizing your vessel.

---

### C.1. Recognizing Reduced Stability

The cutter's intact and damaged stability will be acceptable throughout the normal operating range provided that the liquid loading instructions have been followed, and there are no unusual loads aboard that cause the Limiting KGv and/or trim limits to be exceeded. Nevertheless, operators should pay attention to roll period as a way to recognize situations of reduced stability. The signs of a loss of stability are:

- a. A long, slow roll compared to that which would be ordinarily expected for the wind and sea conditions; or,
  - b. The cutter's hanging at the end of a roll without quickly snapping back to an even keel.
  - c. The longer and slower the roll, the greater the danger of capsizing.
- 

### C.2. Reducing the Danger of Capsizing

To reduce the danger of capsizing, weight must be removed high or weight (but not free water) must be added low in the cutter. These steps will lower the KGv and increase cutter stability. Another preventive measure is to keep all scuppers unplugged. This will reduce weight high in the cutter by allowing water on deck to quickly drain off. A third preventive measure is to keep all watertight doors and hatches securely dogged to prevent water from entering the cutter and finding its way to the bilges, increasing the free surface effect.

---



This page left intentionally blank



## Section D. Flooding and Casualty Control Software (FCCS)

**Introduction** The Flooding and Casualty Control Software (FCCS) program offers shipboard personnel the ability to quickly evaluate a cutter's intact, flooded, or grounded stability. The intact stability analyses that can be performed include beam winds, lifting operations, towing, topside icing, and high speed turns. FCCS also performs load management functions; calculates, displays, and prints the current hydrostatic properties; alerts the user to potentially dangerous situations; and offers recommendations to improve the current situation. Commanding Officers and Engineering Officers are to familiarize themselves with their cutter's FCCS program and to utilize it to help maintain acceptable stability.

**NOTE**

**FCCS support can be obtained by contacting the USCG Surface Forces Logistics Center, Naval Architecture Branch (SFLC-023), phone 410-762-6708.**

- D.1. Loading Conditions** Each cutter's standard loading conditions are included in their FCCS database. A Daily Load Maintenance file is also provided in which cutter personnel can update the dry and liquid loads aboard the cutter daily to reflect current conditions. The periodic updating of this file allows cutter personnel to check the cutter's KGv, drafts, trim and list, all of which can be found on the CO Summary screen.
- 
- D.2. CO Summary Screen** The FCCS CO Summary screen allows operators to check their cutter's stability - including KGv, drafts, trim and list - provided that the load details have been updated to correspond to current amounts.
- 
- D.3. Stability Summary Screen** The FCCS Stability Summary screen allows operators to determine the current maximum allowable beam winds, the maximum acceptable speed when turning, the maximum acceptable RPM for towing operations, and to see where the current KGv is on the Limiting KGv curve – provided that the load details have been updated to reflect current amounts.
- 
- D.4. Flooding** The FCCS Program can be used to determine the effects of assumed and/or actual cases of flooding. On the Flooding Specification screen, personnel can specify the flooded compartments, after which an evaluation of the resulting damaged stability can be obtained.
-



---

**D.5. Lifting Operations**

FCCS can be used to obtain an evaluation of the stability during lifting operations. On the FCCS “Crane Loads” screen operators input the load being lifted, plus the boom elevation and swing angle and then can obtain an evaluation of the intact stability during the lift.

---

**D.6. Grounding**

FCCS allows operators to obtain an evaluation of their cutter’s stability when grounded, including cases when there is also flooding. Input includes the grounding point, the observed cutter attitude (heel, draft, trim), and the bottom type (rock, sand, mud, etc.). The grounding function can then calculate the grounding force, which acts on the hull at the grounding point, this force acts identically to a removal of weight at the hull contact location. The result is that the cutter acts as if it has a higher center of gravity and a lower displacement. By inputting the grounding type (rock, sand, mud, etc.) a horizontal removal force can be computed by FCCS that is based on the coefficient of friction of the bottom type. The grounding removal force is the theoretical bollard pull necessary to pull the vessel free. FCCS can also be used to determine if the tidal shift will be sufficient to free the vessel.

---

**D.7. Icing**

FCCS can be used by operators to obtain a stability evaluation of their vessel with icing. Input includes the ice accumulation in inches at different locations of the cutter. The output includes the maximum allowable beam winds based on the amount of icing that is entered into FCCS.

---



## Chapter 8

# Shiphandling and Boathandling Techniques

---

**Introduction** This chapter introduces the fundamental principles involved in maneuvering and shiphandling essential to successful ATON evolutions. There are numerous publications written on the art and science of shiphandling, *Naval Ship Handling* and *Knight's Modern Seamanship* are two recommended reference books.

WLBB, WLB and WLM buoy tenders are configured with a variety of propulsion control systems incorporated into Dynamic Positioning Systems (DPS). Cutter specific Watch Qualification Systems (WQS) detail shiphandling instructions for these classes. Though these vessels maneuver using non-traditional means, the information in this chapter regarding the effects of screw and rudder, wind and current and prudent seamanship still apply.

---

**In this chapter** This chapter contains the following sections:

Section	Topic	See Page
A	General	8-2
B	Ship-handling and Maneuvering	8-4
C	Buoy Tenders	8-9
D	Construction Tenders	8-17
E	River Tenders	8-19





## Section A. General

---

**Introduction** The following section is applicable to all ship or boat handling during ATON evolutions and are advisory in nature.

---

**A.1. Shiphandling in ATON Work** Shiphandling, especially in ATON work, is a skill gained and honed by constant study, practice, and experience. For a conning officer to develop, they must gain and apply an understanding of the fundamental effects of rudder, propeller(s), and general ship characteristics observed underway. When setting or retrieving buoys or building a fixed aid, the conning officer is often required to put the cutter or boat in places prudent seaman avoid. ATON shiphandling demands constant vigilance. When a buoy is alongside, being hoisted aboard, or set, the slightest inattention on the part of the conning officer can easily and immediately result in a dangerous situation, damage to the cutter, or injury to the crew.

---

**A.2. Providing Development Opportunities** Officers-In-Charge and Commanding Officers should provide shiphandling opportunities for junior personnel allowing them to learn through their experiences to develop the next generation of ATON professionals. Structuring these developmental opportunities, beginning with a planning discussion and concluding with a „hot-wash“, helps new conning officers visualize and think through many aspects of the evolution. Use diagrams to analyze ship handling evolutions and rehearse recurring situations that your vessel typically encounters. Debriefs and constructive critiques after shiphandling evolutions are invaluable teaching tools.

---

**A.3. ORM and TCT** The conscientious and deliberate use of operational risk management and team coordination principles contained in the Operational Risk Management, COMDTINST 3500.3 (series) and Team Coordination Training, COMDTINST 1541.1 (series) is crucial to identifying and breaking error chains by reducing the probability of human error. While shiphandling and technical skills are important components of ATON operations, these alone will not ensure personnel and vessel safety. ORM is required prior to ATON evolutions and coordinated teamwork is a critical component for the safety of the evolution.

---



---

**A.4. Briefings  
and Debriefings**

ATON briefings and debriefings shall be conducted at the beginning of each day and at the discretion of the Commanding Officer/Officer in Charge. These are all-encompassing briefs that discuss safety procedures, review risk assessment, clarify expectations, create a climate for learning and encourage feedback by constructive critique. Operational Risk Management shall be a part of evolution planning and shall be included in these ATON briefings. GAR model scores shall be reassessed as situations change. Changing conditions such as: worsening weather conditions, fouled moorings, vessel traffic, an exhausted crew, broken weight handling equipment, inconsistent positioning equipment, are some examples which required a reevaluation of risk.

---



## Section B. Shiphandling and Maneuvering

---

### Introduction

Some principal factors involved in shiphandling include the cutter's length and beam, displacement and draft, effect of the rudders, thrusters, and engines, depth of water, force and direction of wind and current, and space available for maneuvering (searoom).

---

### B.1 Speed

There are many factors to consider for maneuvering in ATON work. Below are some points to consider during conning evolutions:

Look to your beam. Do not fixate on one object or the electronic charting system when approaching an aid to navigation. The cutter may appear stopped, but you may be moving faster than you realize.

Increasing speed by applying power to the engines may not always be discernible. The conning officer should pay attention to the prop wash and other visual clues such as natural ranges.

Be ready for mechanical or human failure. Loss of pilothouse control, loss of electronic navigation or dynamic positioning systems, or a seaman on deck improperly handling a line could happen at any time. Keeping minimal headway provides time to react to emergency situations.

If for any reason you feel uncomfortable in a maneuvering situation, don't hesitate to slow down, stop or back away. Stop, get into safe water, re-evaluate and try again. Don't force an approach that has changed significantly from the initial plan.

Remember you can always add speed to come ahead, but you cannot always take speed off quickly enough. Know how long it takes to stop the momentum of the cutter based on your speed of advance.

---

### B.2 Know Your Cutter

Know how much power is needed to attain speed, how long it takes for the engines to engage, how the cutter will react to current or wind, how the cutter turns at various rudder (or drive) angles, the relative strength of the thrusters, the diameter of the cutter's turning circle, distance to stop headway at various speeds, the best heading for a stable deck, etc.

---



---

**B.3 Approaches to a Buoy**

First and foremost, never assume an aid is on station. Before making the approach, fix your position and the position of the aid. Verify that you are not standing into shoal water. Use danger bearings, danger ranges and soundings; approach carefully.

Consider wind, current, swells, location of shoal water, and vessel traffic before making the approach. Think of how best to use these forces to assist you in maneuvering the vessel.

Prior to any approach, consider all escape routes open to you and what forces you would apply to get clear. Know the way out.

If working an aid in shallow water, watch bottom contours. Use the information provided by your fathometer and electronic charting system. Don't hesitate to launch a small boat to sound and mark hazards to provide a visual reference of where dangers exist.

Work aids in shallow or uncertain depths during a rising tide.

It is difficult to judge speed of advance in strong current. Watch natural ranges and observe other floating objects or current trails from the buoy.

Ensure all charts and electronic displays are available and set to correct scale.

When working down wind or with a following current, approach with less headway. The vessel will generally be moving faster over ground than you may realize.

Assign personnel to monitor danger ranges and danger bearings. These personnel shall provide regular and timely updates to the conning officer and Commanding Officer. If the vessel is standing into danger, they shall immediately notify the conning officer and Commanding Officer and continue to do so until they receive acknowledgment from them that they understand the situation. This information should be covered in the ATON brief prior to the evolution. Write this information down in a prominent location where it can be easily accessed to avoid confusion.

Maintain constant communication between the buoy deck crew and the bridge to relay environmental conditions, aid location and speed of approach.

---



---

**B.4 Stoppers**

Vessels with chain stoppers servicing buoys in limited searoom, may secure the chain in the stopper and drag the moor to safer water. When dragging a mooring, unshackle the buoy and secure the chain with a pelican hook if time and conditions permit.

---

**B.5 Priority**

There is never a time when working an aid to navigation takes precedence over the safety of the cutter and crew. The determination to work a buoy is always the Commanding Officer's decision. It may be necessary to break off and secure work until another day even after servicing an aid started.

---

**B.6 Dredging the Anchor to Work Buoys**

Commonly referred to as the "Poor Man's Tug," the technique of dredging an anchor is highly effective for maneuvering with a smaller turn radius in challenging wind and current situations (See **Figure 8-1**). Dredging an anchor can mitigate the loss (or absence) of thrusters, as it provides a constant force to drive against and increases the effectiveness of the rudder. Station keep to service an aid while dredging anchor by balancing the cutter's propulsion against the prevailing forces, including the holding effect of the anchor. Consider the following when planning an anchor dredge maneuver:

- a. Bottom type: Review the chart for submarine cables, pipelines and other underwater obstructions, taking great care not to foul the anchor on one of these hazards. Bottom types of shell, clay, mud, sand and the like are ideal for dredging, where rocky or other angular type bottoms will prove difficult.
  - b. Anchor selection: The outboard anchor should be chosen for dredging, leaving the other side of the cutter clear for work.
  - c. Vessel Speed: Vessel speed should be the minimum required for steerageway. Once the anchor is let go and the load shifted off the capstan and onto a hard deck (i.e. pelican hook or pad-eye), the throttle can be increased to dredge the anchor.
  - d. Scope of chain: Use not more than a 2:1 scope of chain relative to water depth. Conditions will dictate, as the actual vessel configuration and type of bottom may require more or less anchor chain to be veered.
  - e. Deck gear: Exercise caution when putting strain on the capstan. It is not enough to rely on the brake or riding pawl to secure the anchor chain while dredging. Should the anchor foul, severe damage could result to the capstan that can render it inoperable. Transfer the anchor chain to a hard deck as soon as practical.
-

**NOTE** 

Prior to engaging in dredging or kedging operations, submerged objects (pipelines or submarine cables) **MUST** be considered.

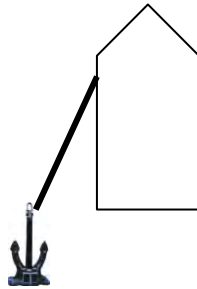

**Figure 8-1**  
Diagram of Dredging an Anchor

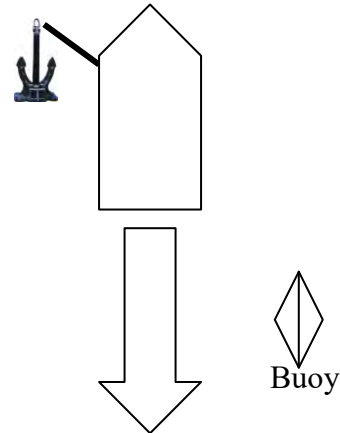

**Figure 8-2**  
Kedging the Anchor with Sternway

### B.7 Kedging the Anchor

Kedging the anchor to service a buoy is the basic technique of allowing the cutter to weathervane in the prevailing conditions while on the anchor and then walking the anchor chain out, thereby getting set astern in order to position the buoy in the buoy port (**See Figure 8-2**). Use this technique when the wind and current are not ideal to safeguard against losing propulsion and getting set into shoal waters. Additionally, the cutter will enjoy some maneuverability with the effect of the current on the rudder. Consider the following when planning an anchor kedge maneuver:

- a. Anchor let go point: The distance from the buoy, as well as the direction in which the cutter will weathervane will dictate where the let go point is established. Some miscalculation can be overcome by use of the rudder and/or thrusters.
- b. Bottom type: Consider bottom type and adjust accordingly for different holding characteristics. Avoid kedging in areas with subcables, pipelines, or other bottom hazards.



- c. Selecting the anchor: Similar to a dredging evolution, use the outboard anchor leaving the other side of the vessel clear for buoy servicing. If conditions dictate the other anchor may be used as the anchor chain will be tending forward.
- d. Water depth and scope of chain: Once on the bottom, the remaining chain will determine the distance the cutter can set towards the buoy.
- e. Trail and error: It's common to relocate the anchor to obtain the proper vessel position relative to the buoy. Determining the anchor let go point takes considerable experience.
- f. Lower the outboard anchor to the bottom. As the anchor lays on the bottom begin to allow the vessel to gain slight sternway (see **Figure 8-2**). This will pay the anchor chain out along the bottom and not pile on top of itself. Veer sufficient chain so that the anchor can hold the vessel in place without the vessel providing much or any propulsion. The aid should be forward of the bow opposite from the anchor (see **Figure 8-3**).



**Figure 8-3**  
Kedging with the Anchor Paid Out

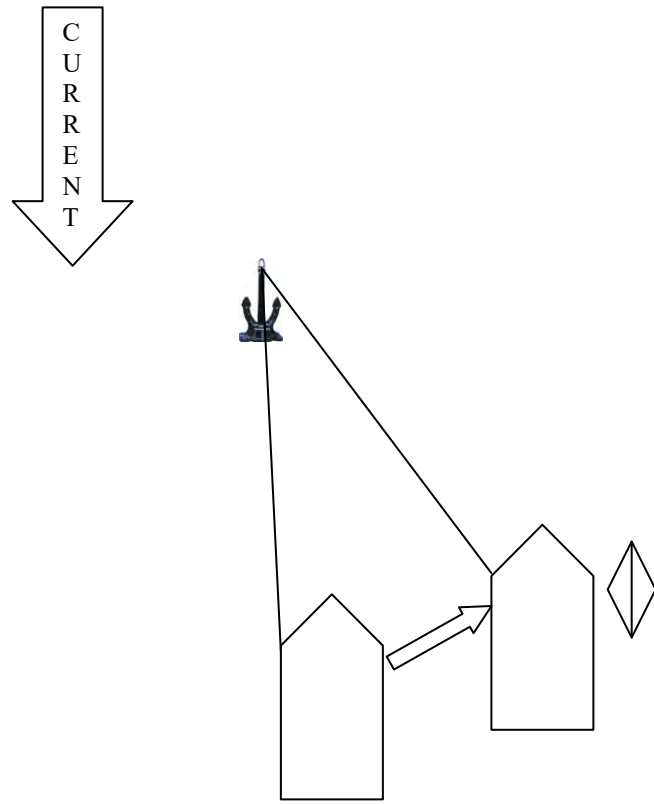

**Figure 8-4**  
Tender Kedging Towards the Buoy



## Section C. WLBB, WLB, and WLM Tenders

---

### Introduction

Advances in ship handling and propulsion technologies have made the positioning of aids to navigation incredibly accurate. The modern era of Coastal and Sea Going Buoy Tenders requires little hands-on work by the conning officer. This section describes propulsion equipment on WLBB, WLB, WLM cutters and associated best conning practices. Each cutter class has its own quirks that require practice to fully master the differences between conventional cutter driving and driving an ATON cutter with modern technologies.

---

### C.1. WLBB Shiphandling Considerations

This section covers the fundamentals and basics of shiphandling on the USCGC MACKINAW.

---

#### C.1.a. WLBB Propulsion and Control

The propulsion plant in MACKINAW consists of 3 Caterpillar 3612 diesel generators, each producing 3130 kilowatts that provide AC power to two electric Asea, Brown and Boveri (ABB) Azipod© drives. Each Azipod, or “Pod” produces over 4506 HP and can deliver 33 tons of thrust (bollard pull), 360 degrees along a horizontal plane. This highly maneuverable feature allows for a stationary cutter rate of turn of over 360 degrees per minute. With both steering pumps energized, the Azipods can rotate nine degrees per second. This high-level of responsiveness requires that the operators attain a greater level of skill to safely operate the vessel, especially at higher speeds.

---

#### C.1.a.1 Bow Thruster Limits

The bow thruster produces 550 HP which creates a “thruster imbalance” between pod thrust capabilities at the stern and available thrust forward. The bow thruster becomes ineffective at speeds above 3 knots. Transiting narrow, shallow channels and maintaining station with strong beam winds is affected by this “thruster imbalance”.

---

#### C.1.b WLBB Modes of Pilothouse Control

There are three primary modes of control on the bridge:

“Manual” mode allows the conning officer to independently direct the azimuth and thrust of an Azipod via tractor controls (TC-21). The TC-21 azimuth lever controls can also be “grouped” to allow synchronous control of both pods with a single TC-21 unit.

“DP” mode uses the Kongsberg Simrad Dynamic Positioning System (SDPS) to control the movement the cutter. The conning officer can select control of one, or any combination of surge, sway and yaw. When DP is controlling all three horizontal freedoms of movement, the cutter is in full

---





---

DP “auto position” mode. The DP system also facilitates autopilot operation for auto track, auto heading, auto course, and auto waypoint. The DP system can pass auto pilot control remotely to the integrated ECDIS or RADAR, and control of surge to a remote TC-21 manual control unit.

“SJS” (Simrad Joystick) mode is an independent joystick system located on the bridge centerline, that provides the conning officer back-up control of the cutter if Manual and DP operation fail.

Back-up pilothouse controls on the bridge consist of Non-Follow up (NFU) and Engine Order Telegraph (EOT). Independent NFU controls are also located in the Azipod Space and in the Engineering Control Center (ECC). ECC can take manual control utilizing TC-21 azimuth levers located in ECC. The after conning station is equipped with an independent Furuno RADAR, ECDIS repeater, conning screen, and a portable TC-21 control unit.

---

### **C.1.c ATON and Dynamic Positioning**

The SDPS uses environmental sensors and two independent position reference systems (DGPS) to control the thrusters and precisely position the cutter around a designated reference point. The Azipods require a minimum of 8-10 percent thrust demand to maintain immediate thruster response needed for “Auto positioning.” For this reason, the thruster allocation mode of “Force Bias” is used. Force Bias thruster allocation mode is one of several allocation modes. This mode will maintain a selected minimum amount of thruster force output, but since the pods default to an opposed position, the resultant thrust affecting the movement of the cutter is zero. Increasing the level of thrust in force bias thruster allocation mode will dampen heave moment that could help stabilize the buoy platform when working stern-to in heavier seas. Other thruster allocation modes include; “Variable,” “Manual Fixed,” “Steering”, and preset “Fixed 1” and Fixed 2.” Relocating the cutter’s position by either disabling one or more horizontal freedoms of movement and using the joystick to maneuver, or incrementally changing any of the surge, sway and yaw settings.

---

### **C.1.d Observations**

When shifting from DP to Manual mode, the receiving TC-21 azimuth controller must be set to zero azimuth and zero thrust. The controller will not accept conflicting thruster demands shifting from DP control to manual control. The system will refuse any further helm command until it is reset from ECC which can take 30 to 40 seconds. NFU control is still possible from the bridge, without ECC reset.

The Azipods themselves provide little wash deflection compared to a rudder. The sudden removal of thrust could result in abrupt and uncontrollable heading changes. This is especially apparent when trying to slow down too rapidly while backing at higher speeds.

---



---

The most efficient method to “crash stop” or “emergency stop” MACKINAW from full ahead is a procedure called “Transverse Arrest.” Transverse Arrest produces breaking action by applying propeller wash perpendicular to the cutter. Due to potentially damaging high vibration caused applying full thrust with opposed pods, the following best practice is most effective: Reduce thrust to 60 percent, and simultaneously oppose pods. Once the cutter speed has been reduced to below 10 knots, continue azimuthing the pods inboard to 180 degrees, then apply full thrust.

When transiting a narrow channel at slow speed with a single pod, leave the inactive pod to windward. “Dragging” the upwind pod will reduce crab angle by inducing a “twisting action” into the wind. Conversely, dragging the downwind pod will increase drift to leeward, thereby increasing the crab angle required to maintain the Navigator’s track line.

In DP “current” is the only environmental input not measured, but calculated. Commonly referred to as “Kongsberg Current,” this calculation is the difference between the predicted cutter’s mathematical model position and the cutter’s actual position. Any unmeasured resistance to movement such as wave action, or even when alongside piers will be calculated as “Current.” Use “Quick Model Update” whenever there is a sudden change in environmental conditions, or when the wind sensors are blocked.

Do not direct propeller wash towards the other pod. Not only will thruster effectiveness be reduced, but there is potential for damage caused by unnecessary strain to the bearing and housing unit of the affected pod.

Conning Officers should know that placing the TC-21 control to zero thrust for periods longer than 15 seconds, can result in a temporary loss of pilothouse control.

---

### **C.1.e Available Resources**

To assist the conning officer, job aids, tutorials, doctrine, qualification guides, and tailored commercial courses have been developed. In addition, the cutter is billeted with a civilian performance manager and training specialist. The civilian billet administers the on-board, Kongsberg Polaris visual cutter simulator that provides extensive ship handling, rules of the road, SDPS, RADAR and ECDIS operating procedures. The simulator also serves as an integral part of Operational Risk Management (ORM) assessments.

---



---

**C.2. WLB  
Shiphandling  
Considerations**

This section covers basics of shiphandling specific to the 225' WLBs.

---

**C.2.a WLB  
Propulsion and  
Control**

The 225' WLB has a single controllable pitch propeller and bow and stern thrusters which provide the maneuverability needed to tend buoys. A sophisticated Machinery Plant Control and Monitoring System (MPCMS) and an Electronic Chart Display and Information System (ECDIS) enable the WLB to reduce the watch standing complement compared to traditional cutters. A Dynamic Positioning System (DPS) can hold the vessel within a 10 meter circle using the Global Positioning System.

The unique propulsion system aboard WLB cutters provides four elements to the conning officer: Controllable pitch propeller (direction and force), Bow thruster control, Stern thruster control and rudder control. Conning officers have the option of either manual control using the main throttle control, bow and stern thruster controls, and the helm (MPCMS or manual) or automatic control using the Dynamic Positioning System (DP-Joystick).

The DPS computer combines the thrusters and main screw into an omni-directional joystick and heading control knob, providing simplified maneuvering control to the conning officer through use of the "hold head" and/or "hold position" features. Conning officers must be skilled at quick/fluid transfer of propulsion control modes to recover from casualties in DP-Joystick mode and restore manual control.

---

**C.2.b New WLB  
Shiphandlers**

The WLB is a large cutter; possibly the largest most WLB break-ins will have experienced.

The single-screw WLB has a strong tendency to back to starboard.

The stern thruster is stronger than the bow thruster to counter the significant side forces of the single screw.

The bow and stern thruster are most effective at slow speed or dead in the water. The thruster effectiveness wanes as speed increases and the thrusters are not effective above 4-5 knots.

---



---

**C.2.c  
Comparison to  
Other Cutters**

The below paragraphs will help conning officers from other cutters adapt to the uniqueness of a 225" WLB.

Shiphandlers with prior experience on 140" WTGBs will find that the 225" WLB handles like a large-"ruddered," single screw cutter. The WLB turns well with ample speed and rudder and has a pivot point forward of the pilothouse. Starting with little or no headway, a good strong "shot" of the throttle with full or hard rudder pivots the cutter with minimal forward momentum.

Sailors of the 175" WLM will notice the difference of increased draft on the 225" WLB. The WLB doesn't "slide around" like a WLM. The familiarity between WLM and WLB conning stations is purely cosmetic. The 225" is a much heavier cutter than the 175" most apparent when trying to slow the WLB. The relative strength of the WLB's bow thruster is less than the WLM's and correspondingly less responsive.

Sailors of the 140" and 175" will find that the 225" WLB has a larger percentage of cutter forward of the OOD's pilothouse vantage point. Due to the increased height of eye and well protected conning stations there is markedly less "seat-of-the pants" (or boots) feel to the WLB. The visual cues are everything in reckoning subtle changes in momentum.

Deck watch officers oriented to twin-screwed WMECs and WHECs, while accustomed to the WLB's tonnage, need to learn single screw dynamics. A significant difference is the challenge of quickly slowing a WLB while maintaining the cutter's heading. Astern propulsion moves the bow to port and the swing is proportionate to the backing bell used. The bow thruster is unable to counter this swing. When decelerating in a strong current the conning officer can find the cutter several points off the current in a matter of seconds.

Patrol Boat deck watch officers will notice the option to "power out" of danger on a WLB is limited, especially in Maneuvering Mode when power is diverted to the Bow and Stern thrusters.

---

**C.2.d The Dead  
Zone**

The WLB's controllable pitch propeller (CPP) responds quickly to helm commands with immediate changes in thrust. However, the CPP in the neutral pitch (zero thrust) throttle position creates a column of dead or dragged water which severely dampens the rudder's effectiveness. With less than about 5 knots of headway, you need to apply large amounts of rudder to create even a small turning force in the zero-thrust throttle position. The cutter needs a fine, close hand while coasting in the 3-5 knot speed range - especially operating alongside - where large amounts of rudder or thruster may not be desirable

---



---

**C.2.e Program Control Modes**

Although emergency direct control of the engines and propeller pitch is possible in ECC Manual Mode, the WLB will normally be operated in Programmed Control where throttle, pitch, and thrusters are actuated by throttle and thruster controls. Under Programmed Control, the cutter can be maneuvered in either Transit Mode or Maneuvering Mode.

Transit Mode permits engine speed and pitch to vary with throttle commands. Thrusters are not available. Autopilot functions hold heading, hold speed, and follow track are available.

In Maneuvering Mode, shaft speed is a constant 203 RPMs and the thruster generator is engaged. Thrusters are available and the cutter can be operated using either the MPCMS throttle and thruster knob controls or using the Dynamic Positioning control stations.

---

**C.2.f MPCMS vs. DP**

While in Maneuvering Mode, the choice of conning the cutter using MPCMS or DP-Joystick depends on many factors: the type of evolution, CO's preference, environmental conditions, and the conning's officer's experience level. Other important factors to consider include:

In MPCMS mode, the throttle controls the propeller pitch, and each thruster dial controls its respective thruster. Independent use of the thrusters is allowed. The cutter is most maneuverable in this mode.

In DP-Joystick mode, the joystick controls the propeller pitch, and can also control the thrusters for the purpose of inducing lateral momentum changes (moving sideways or stopping sideways movement). The dial control *always* actuates both the bow and stern thruster.

DP-Joystick mode is better for working ATON. In this mode the "hold heading" and "hold position" functions are a button-push away. Also, independent thrusters control is seldom needed during ATON operations.

MPCMS Mode is usually the best choice for operations alongside (mooring, unmooring, or approaching a tow), since independent control of the thrusters is often highly desirable in these cases. Also, operating in MPCMS Mode offers a better "manual" training experience for new conning officers than does the more automated mode.

The built-in secondary/redundant propulsion controls on the WLB are as numerous as they are complex. Commanding Officers are strongly encouraged to conduct frequent training in all control modes to enhance their abilities, and improve casualty response techniques.

The decision between MPCMS or DP-Joystick modes, and how the rudder will be controlled: by the OOD directly at the conning station, or through the use of a helmsman, remain within the CO's discretion.

---



---

### **C.2.g WLB / WLM DP Mode**

WLM and WLB bridge teams undergo a comprehensive resident training school to learn the complicated MPCMS system. Some conning applications of DP features are explained below:

In DP mode, the computer prioritizes thruster power to maintaining heading or turning, thrusting the cutter to the directed position is a secondary priority. The default setting can be changed in the DP computer but most Commanding Officer's prefer to let the DP system favor holding the cutter's heading more than its position.

The "hold position" button can be used as a crude brake. However if engaged when making over one knot, the cutter will shake and vibrate excessively. This method works better on the lighter WLM.

The "Remote Center of Rotation" function is better suited to the WLM than the WLB. The larger WLB will expend significant thruster and engine RPMs trying to shift the pivot point away from the cutter's natural center of rotation. Allocation of Z drive thrust enables this on the WLM.

A conning officer's effective use of DPS must include an understanding of the time necessary for the computer to build the "model" while the hold position feature is enabled. A good hold position model takes 8-12 minutes to develop and the time is dependent on the environmental conditions.

DPS faults/alarms are cause for concern when passing under bridges because of the DGPS signal interruption. It is strongly recommended to deselect the "Follow Track" feature of the DPS (autopilot mode) when passing under bridges (note: Hold course can still be used).

---

### **C.3. WLM Shiphandling Considerations**

This section covers basics of shiphandling specific to the 175' WLMs.

---

#### **C.3.a. WLM Propulsion and Control**

The 175 foot WLM is the first Coast Guard Cutter class equipped with Z-Drive propulsion units instead of the standard propeller and rudder configuration. The „Z-Drives“ independently rotate 360 degrees. The WLM also has a 500HP bow thruster capable of port or starboard thrust. A Dynamic Positioning System can hold the vessel within a 10 meter circle using the Global Positioning System.

**C.3.b. WLM  
Shiphandling  
Considerations**

The unique propulsion system aboard 175' WLM cutters provides 5 propulsion elements to the conning officer: Z-Drive azimuth control (2ea), Z-Drive propeller speed control (2ea), and Bow Thruster control. Conning officers have the option of either manual control using Z-Drive Direct Control (Z-Con) or automatic control using the Dynamic Positioning System (DPS).

The DPS computer combines the 5 available propulsion elements into an omni-directional joystick and heading control knob, providing simplified maneuvering control to the conning officer through use of the "hold head" and/or "hold position" features. Conning officers must be skilled at quick/fluid transfer of propulsion control modes to recover from casualties in DPS mode and restore manual Z-Con control.

Z-con control of the vessel's propulsion system provides conning officers an opportunity to develop a conning skills by directly countering elements with the propulsion elements.

Working aids to navigation in DPS mode increases the efficiency of the cutter and creates a safer work platform for the deck crew. Under most circumstances the "hold position/hold head" feature of DPS works extremely well and reduces the time needed to maneuver a cutter through the entire buoy evolution. A good hold position model takes 8-12 minutes to develop, depending on environmental conditions.

**C.3.c. Unique  
WLM  
Considerations**

The cutter rolls excessively while transiting in centerline tiller mode which is caused by the directional force of the Z-Drive as the helmsman applies small port/starboard changes to maintain an ordered course. This is simply a design feature of the cutter, but it can be reduced by placing one of the Z-drives in secondary control trained to 180 (relative), thus removing it from helm control. The effect of removing one of the Z-Drives from helm control reduces the rolling motion with little impact to maneuverability.

The symptoms of a clogged Z-Drive most frequently appear as a loss of power/speed. If the forward face of the Z-Drive becomes clogged by ice during ice breaking operations there are several methods to relieve the ice blockage. Use the opposite Z-Drive to blow out the ice. Reverse the direction of the clogged Z-Drive and clutch out; effectively dragging it backwards to flush the ice out.

The built-in secondary/redundant propulsion controls on the 175 WLM are as numerous as they are complex. Commanding Officers are strongly encouraged to conduct frequent training in all control modes to enhance their abilities, and improve casualty response techniques.



## Section D. Construction Tenders

<b>D.1 WLIC Considerations</b>	<p>The Construction Tender fleet consists of 160ft cutters and 100ft and 75ft tugs that push 70ft, 68ft and 84ft barges. Each of these vessels requires specific knowledge gained from experience of the individual cutter and operating area. The following should be considered by the conning officer when maneuvering.</p> <p>Due to the shallow draft and sail area of the Construction Tender, current and wind conditions need to be carefully evaluated for each evolution to determine their effects.</p>
<b>D.1.a. Flanking Rudders</b>	<p>The 75ft class of WLICs are fitted with flanking rudders. These rudders are forward of each propeller and allow a higher degree of maneuverability when backing, pivoting and walking. (See figure 8-5 and 8-6).</p>
<b>D.1.b. Bow Blind Spot</b>	<p>Due to the configuration of the Construction Tender, which includes the distance from the bridge to the bow of the cutter and the location of the crane and cab, there will be a point where the aid will not be visible from the bridge. It is extremely important for the construction deck to be in constant communication with the bridge to relay the position of the aid and speed of approach.</p>
<b>D.1.c. Crane Limitations</b>	<p>Do not conduct crane operations with wind speeds greater than 20 mph (17.5 knots). The cutter can work with the stern to the wind to minimize the side loading of the wind to the crane and provide a lee for the crew on deck.</p>
<b>D.1.f. Pivoting on Spuds</b>	<p>Spuds are used to pivot and maneuver the Construction Tender to the assigned position of the aid as well as general maneuver. By using the various spuds in combination with the engines and rudders, the pivot point of the cutter can be moved forward/aft of port/starboard as needed for maneuvering.</p>
<b>D.1.e. Depth Limitations for Spuds</b>	<p>Spuds have minimum and maximum water depth limitations. Minimum water depth is limited by the cutter's draft. Depending on cutter class and loading and ballast condition, minimum depth is generally limited to not less than 4ft. Maximum depth is dependent on spud length by cutter class. Cutters with 45ft spuds are generally limited to construction operations in water depths not greater than 25ft and for 35ft spuds water depth no greater than 20ft.</p>



**D.1.f. Spud Effectiveness**

The spuds effectiveness and holding power is dependent on bottom type and penetration achieved, water depth and environmental conditions. Spudding in very soft bottoms may achieve adequate penetration, but may not achieve enough holding power to keep the cutter in position. Conversely, in hard, rocky or coral bottom, spuds may not achieve enough penetration to hold the cutter in position. In deeper water or with strong winds and currents, the cutter could surge on the spuds possibly damaging the spuds or cutter's hull.

---

**D.1.g. Spuds are not brakes.**

The cutter should be DIW or have only minimal way on when lowering spuds. Only in an extreme emergency should spuds be considered to slow or stop the cutter. Spudding down at speed could bend or damage spuds or the hull. Spuds shall be pinned when transiting and when not manned. Exercise caution spudding down near cable and pipeline areas.

---

**D.1.h. Spudded for an Extended Durations**

When spudded for any length of time, check spud wires and adjust as needed. On a rising tide, if spud wires are not kept slack, the spuds can lift off the bottom. Closely monitor vessel traffic. Wake from larger deep draft vessels can cause unsafe working conditions on deck, and damage the spud or spud wires.

---

**D.1.i. Working Buoys**

In addition to building fixed aids, some Construction Tenders service buoys. Approaching a buoy is not much different than approaching AP for a fixed aid. Since a Construction Tender services aids while spudded, consider excursion of the buoy before spudding down. Avoid dropping a spud on the sinker or mooring chain. Evaluate wind and current, water depth and scope of chain to spud with the sinker off the bow and minimize the outboard lead on the mooring chain when picking up the buoy.

---

**D.1.j. Sweeping Wreckage**

Procedures for sweeping and recovering wreckage from damaged fixed aids are covered in another chapter in this manual. Approach slowly, keep the wreckage forward of the bow and avoid running over the wreckage.

---



## Section E. River Tenders

<b>E.1 WLR Considerations</b>	<p>A River Tender services river buoys on the Western Rivers. These buoys are set to mark a prescribed water depth and provide the greatest channel width to the mariner. Buoys are repositioned as river levels fluctuate. During periods of rain or drought, water levels can change significantly prompting river tenders to relocate buoys. The Officer-in-Charge must monitor river gauges, ACOE data, predicted water levels and the weather to ensure the cutter is prepared to set and reposition buoys as needed.</p>
<b>E.1.a Ship Handling</b>	<p>The River Tender fleet consists of 65ft and 75ft cutters. These cutters push 90ft, 99ft and 130 ft barges. Each of these combinations requires specific knowledge gained from experience of the individual cutter and operating area.</p>
<b>E.1.a Ship Handling</b>	<p>The main environmental factor is current. For most of the free-flowing areas of the Western Rivers, buoys are worked up river into the current. Buoys are pre-set at the buoy port with sinkers arranged on dump boards. As the cutter approaches the desired position, the buoy / mooring are pushed / dumped over the side. This typically occurs while the cutter has way on. Exercise care to avoid the buoy or mooring as it passes down the side.</p>
<b>E.1.b Pooled Water</b>	<p>In areas above locks and dams, the river pools and the water level remains somewhat constant. Current does not flow in the same way as the uncontrolled portions of the river. Because of this, buoys require much less frequent repositioning and can be worked similar to a buoy tender. The river tender can maneuver and hold station or spud down while setting and recovering buoys.</p>
<b>E.1.c Fast Water</b>	<p>In some areas, water flow can be significantly greater. Typically in the area of dikes, below dams and locks, and the outside of bends. Working buoys in these areas requires the conning officer to exercise greater caution. Buoys are still worked with the cutter heading into the current, however hydraulic effects of water moving over and around these restrictions and obstructions causes eddies and bank suction that can force the cutter into shallow water or onto the obstruction or dike.</p>
<b>E.1.d Walking the Cutter</b>	<p>It is possible to walk a River Tender side-to side and pivot port or starboard using a combination of spuds, engines and rudders. This is useful when approaching the aid or for precision maneuvering.</p>



---

**E.1.e Spuds as a pivoting tool**

Spuds are used to pivot the River Tender for general maneuvering and mooring. By using spuds in combination with the engines and rudders, the pivot point of the cutter can be moved forward or aft.

---

**E.1.f Spuds are not Brakes**

The cutter should be DIW or with very minimal way on when lowering spuds. Only in an extreme emergency should spuds be considered to slow or stop the cutter. Failure to properly use spuds as designed could result in bent or damaged spuds or damage the cutter's hull. Spuds shall be pinned when transiting and when not manned. Exercise caution when using spuds near cable and pipeline areas.

---

**E.1.g Spudded for Extended Durations**

When spudded for any length of time, check and adjust spud wires to accommodate changing river levels. Closely monitor vessel traffic. Wake from larger deep draft vessels can cause unsafe working conditions on deck, and damage the spud or spud wires.

---

**E.1.h Beaching the Barge**

River Tenders also construct fixed aids on shore. This requires the conning officer to push the barge onto the river bank near to the position the aid will be built. If there is significant current in many areas of the river, the cutter/barge holds position on the bank by keeping the rudders turned into the bank and keeping a few turns on the outboard shaft. In slack or pooled water areas, spuds can be used to hold position.

---

**E.1.i Recovering Buoys**

Frequently a River Tender will have to retrieve stray buoys on the bank. Use the bow of the barge to clear debris from a buoy or mooring, or retrieve buoys submerged due fouling or fast current. Each of these situations is unique and requires conning skill.

---

**E.2 Flanking Rudders**

All of the 75" WLRs and some 65" WLRs have flanking rudders in place. Flanking rudders are a pair of rudders installed forward of the screw, used for maneuvering when the propellers are turning a stern regardless of the direction of actual movement of the towboat. Flanking rudders are also called backing rudders (see **Figures 8-5 and 8-6**).

---

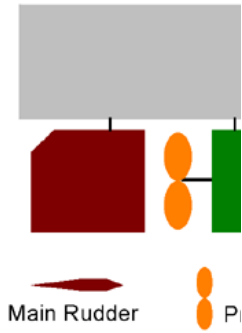

**Figure 8-5**  
**Side View of**  
**Flanking Rudders**

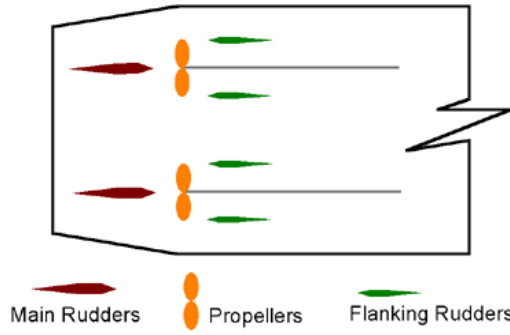

**Figure 8-6**  
**Overhead View of Flanking Rudders**



This page left intentionally blank



## Chapter 9

# Seagoing and Coastal Buoy Tender Operations

---

**Introduction** This chapter presents an overview of weight handling operations aboard the MACKINAW, JUNIPER, and KEEPER Class buoy tenders (WLBB, WLB, and WLM). This chapter is not intended to cover all weight handling situations encountered on these cutters while executing Coast Guard missions. However, the safety rules, standard evolution procedures, and sound seamanship practices outlined in this section shall be followed whenever engaged in any weight handling evolution.

---

**In this chapter** This chapter contains the following sections:

Section	Topic	See Page
A	General Information	9-3
B	Standard Evolution	9-6
C	Special Evolutions	9-17

---



This page intentionally left blank



## Section A. General Information

**Introduction** This section contains the general description and characteristics of buoy deck equipment on the 240 WLBB, 225 WLB, and 175 WLM classes of cutters.

Personnel are also encouraged to seek additional information from the Naval Engineering Manual, COMDTINST M9000.6 (series) and other applicable technical publications.

**A.1 WLB and WLBB Crane Description** The 225" WLB is equipped with a hydraulic telescoping crane. The "A" class has an Allied Systems model TB 90-60 crane and the "B" class has an Appleton Marine model EB-480-60-40 crane. Certain technical data is provided below. Detailed specifications and information can be found in CG Tech Pub 3557.

Rated hoisting capacity on both cranes is 40,000lbs for the main purchase and 10,000lbs on the whip or auxiliary hoist. The whip on the Allied crane is certified for lifting personnel.

**NOTE**

**If the GH50CT (constant tension) winch on WLB A class cutters has been replaced with the GH50 (non-constant tension) winch, the wire rope on the main is same as the WLB 'B' class main below.**

**A.1.a WLB 'A' Class Crane Characteristics**

Maximum Swing Range	175 Deg each direction
Boom Angle (min/max)	0 Deg to 80 Deg
Boom Length – Main	Telescoping – 40" to 60"
Boom Length – Whip	Telescoping – 40"-9" to 64"-9"
Maximum Height: Main / Whip	78" - 4" / 82" - 3" at max elevation angle
Winch Speed – Main / Whip	40" / 60" Feet per minute
Minimum Hook Radius – Main	14 ft 8 in
Minimum Hook Radius – Whip	16 ft 9 in
Wire Rope (Main)	275" of 1-1/8" 6 x 37 XIP, IWRC – Breaking Strength 130,000 lbs (see note)





**A.1.b WLB ‘B’  
and WLBB  
Class Crane  
Characteristics**

	next page)
Wire Rope (Whip)	200’ of 7/8” 6 x 37 XIP, IWRC Breaking Strength 79,600 lbs
Maintain a minimum of 5 wraps of wire rope on drums at all times	
Maximum Swing Range	175 Deg each direction
Boom Angle (min/max)	-10 Deg to 77 Deg
Boom Length – Main	Telescoping – 40’ to 60’
Boom Length – Whip	Telescoping – 40’-9” to 64’-9”
Maximum Height: Main / Whip	78’ - 4” / 82’ - 3” at max elevation angle
Minimum Hook Radius – Main	14’ 8”
Minimum Hook Radius – Whip	16’ 9”
Wire Rope (Main)	300’ of 1” DYFORM 18 – Breaking Strength 115,000lbs
Wire Rope (Whip)	200’ of 3/4” 6x37 IWRC EEIPS – Breaking Strength 64,800lbs
Maintain a minimum of 5 wraps of wire rope on drums at all times	

**A.2 WLM  
Crane  
Description**

The 175’ WLM is equipped with an Appleton Marine model SB230-42 hydraulic crane. Rated hoisting capacity is 20,000lbs for the two-part Main and 9,000lbs for the Whip. Detailed specifications and information can be found in CG Tech Pub 3630.



**A.2.a WLM  
Crane  
Characteristics**

Maximum Swing Range	175 Deg each direction
Boom Angle (min/max)	-10 Deg to 79 Deg
Boom Length – Fixed	Main 42ft / Whip 44ft
Wire Rope (Main)	220' of 3/4" 6x37 IWRC Compounded Construction – Breaking Strength 74,400lbs
Wire Rope (Whip)	140' of 5/8" 6x37 IWRC EEIPS – Breaking Strength 45,400lbs
Maintain a minimum of 5 wraps of wire rope on drums at all times	

**A.3 Deck  
Winches**

Each Coastal and Sea Going buoy tender is equipped with four cross deck winches located in the four corners of the buoy deck.

**A.3.a WLBB /  
WLB 'B' Class  
Cutters**

The WLBB winch is the Appleton Marine BMD-0504 cross-deck winch; the „B“ Class WLBs have the Appleton Marine BMD-471. The winches are designed to carry 125' of 7/8" wire rope. The winch can generate 10,000 pounds of line pull at 60 feet per minute. More detailed information on the winches can be found in Technical Publication #3745 for the WLBB and #3558 for the WLB.

**A.3.b WLB 'A'  
Class Cutters**

The „A“ Class WLB fleet is equipped with the Appleton Marine BMD-390 cross-deck winch. The winch is designed to carry 125' of 7/8" wire rope. The winch can generate 10,400 pounds of line pull at 60 feet per minute. More detailed information on the winch can be found in Technical Publication #3558.

**A.3.c WLM  
Class Cutters**

The WLM fleet is equipped the Appleton Marine BMD-463 cross-deck winch. The winch is designed to carry 100' of 5/8" wire rope. The winch can generate 6,000 pounds of line pull at 60 feet per minute. More detailed information on the winch can be found in Technical Publication #3631.

**A.4 Chain  
Inhaul Winch**

The WLBB, WLB, and WLM fleets are equipped with the Marinette Marine Corporation Chain In-Haul Winch. The winch is a variable speed winch capable of sustaining a line pull of 16,500 pounds at 40 feet per minute. It is designed to receive mooring chain ranging in size from 7/8" to 1 7/8". More detailed information for the in-haul winch can be found in Technical Publication #3498.



This page intentionally left blank



## Section B. Standard Evolution

---

**Introduction** The following section describes the standard evolution for working a buoy from the initial approach and hooking into the buoy, to setting the buoy and moving away. The chain inhaul winch will be discussed in this section while the staged lift evolution will be discussed under special evolutions (Section C).

**B.1 Deck Set Up** The following items shall be completed prior to the cutter maneuvering alongside the buoy.

- (1) A safety and evolution brief is conducted to identify and assign individual roles and responsibilities, a general plan of action for the servicing the buoy, and actions to be taken in the event of an emergency.
  - (2) Where applicable, energize and exercise all appropriate deck equipment. Exercise all buoy weight handling equipment including the crane, deck winches, and chain stopper. Gripes are inspected and exercised to ensure proper operation. Permission should be requested from the bridge prior to exercising the crane.
  - (3) Rig the bull chain, pelican hooks, snatch blocks, and other applicable deck gear and tools.
  - (4) Open the horse collar on the chain stopper.
  - (5) Ensure the inhaul winch chain is paid out a sufficient amount as to retrieve a bite of mooring chain.
  - (6) Rig a deck winch to hog chain into the desired chain stopper.
  - (7) Rig cross-deck(s) and fairlead blocks for horizontal control of the load.
  - (8) Position head blocks, saddles and/or dunnage to receive the buoy.
  - (9) Slew the crane/boom outboard toward the center of the working buoy port and spot the hook.
  - (10) Remove the lifelines located in the working buoy port. Ensure that the safety chain is rigged.
  - (11) When all is ready on the buoy deck, the Buoy Deck Supervisor (BDS) or Safety Supervisor notifies the bridge: "READY ON DECK."
-



---

**B.1.a The Approach**

Before approaching the aid, determine that the aid is on its charted position. The buoy is approached on either the port or starboard side depending on environmental conditions, deck space availability, and cutter's standard practices. Once alongside, boat hooks, line-reeving device, cage lines and other equipment are used to steady the buoy alongside near the buoy port in preparation for hooking and hoisting the buoy aboard. Depending on the weight of the buoy to be lifted, the main or auxiliary hoist is used (in conjunction with a lifting sling) to hook into the buoy's offset lifting bail. **Figure 9-1** shows the hoisting arrangement for bringing buoys aboard the buoy deck.

---

**B.2 Bringing the Buoy Onboard**

Once the buoy is alongside the cutter, the following steps shall be taken in bringing the buoy aboard.

- a. Pass "READY ON DECK" to the bridge. The bridge will reply "MAKING OUR APPROACH".
- b. The bridge will give permission to "HOOK IT WHEN YOU CAN."
- c. Pass a cage line through the buoy cage from the forward part of the buoy deck or forecastle and secure it to a designated cleat. This will act as a sea painter, steadying the buoy as it is brought alongside.
- d. The buoy is hooked with either the main hoist or auxiliary hoist using a synthetic lifting sling or chain pennant as discussed in brief.

**NOTE** 

**The WLBB, WLB and WLM have the capability to hold position stern to the wind and current. In these situations it may be better to tend the cage line from a position aft of the buoy port.**

---

- e. The crane is then slewed inboard until it achieves an inboard lead and the buoy rests just below and outside the buoy port.
- f. The crane hook is then manually moused if utilizing a picking pennant.
- g. When the hook is moused and all personnel are clear, remove the safety chain and take up on the hoist and ease the cage line as necessary to allow the buoy's cage to swing inboard. (**Figure 9-2**)



**Figure 9-1  
Hoisting Arrangement**



**Figure 9-2  
Buoy Swinging Inboard**

**NOTE**

**Mechanical mousing systems shall not be used in the buoy or sinker lifting bail.**

**WARNING**

**When the hoisting tackle is hooked, hoist rapidly until the buoy is out of the water since a sharp roll of the ship might cause the hook to jump free or fetch up all the slack in the wire rope and shock load the crane.**

**Personnel handling the hoisting tackle while hooking must be particularly careful to avoid getting their hands caught in the wire rope or block as the buoy is hoisted.**

- h. Pin the buoy against the sill of the buoy port. Attach the crossdeck line(s) to the buoy. Crossdeck lines aid in limiting the buoy's horizontal movement and do most of the work when dragging a buoy across the deck. The number and location of crossdeck lines used will vary according to the buoy's size, prevailing conditions, intended placement of the buoy on the deck, as well as location of other equipment, buoys, or other interferences already on deck.

**WARNING**

**Whenever a mooring chain is leading over the edge of the deck, secured in a stopper, or pelican hook, the deck crew shall be alert for a sudden movement of the chain fore and aft due to wind, current or moving ice flows.**



- i. With tension on the crossdeck and an outboard lead with the crane, the cage line is shifted to the opposite bulwark. Using a combination of the crossdeck line(s) and the buoy crane (See **Figure 9-3**), the buoy is maneuvered low and slow over the buoy deck until it is just above the saddle (dunnage for flat bottom buoys).



**Figure 9-3**  
Centering the Buoy on the Deck



**Figure 9-4**  
Hogging into the Stopper

**NOTE** 

**The crossdeck line(s) and crane should provide opposing forces on the buoy. The cage line is used to control the buoy cage while the buoy is maneuvered to the saddle. The key is to have three points of control on the buoy at all times.**

- j. Using the chain inhaul winch, the buoy's mooring chain is first hooked to the chain inhaul winch pendant, then pulled to create an approximate 90° angle between bridle and deck edge. The buoy chain is then hogged into the desired chain stopper using the crossdeck winch closest to the chain stopper being used (See **Figure 9-4**). Each time the chain is placed in the stopper, it shall be seated with a sledgehammer. The hook on the crossdeck and chain inhaul winches should face up when connecting to the mooring chain to prevent the hook from falling out of the chain or snagging on deck obstructions. Slings or Modeer shackles should be used on small mooring chain to prevent point loading the hook on the hogging line or side loading the buoy chain.
- k. The chain is secured fully in the throat of either the mechanical or the hydraulically actuated chain stopper with the load on the stopper. The pelican hook is set and the hogging and chain inhaul winch hooks are cleared.
- l. The buoy is lowered into the saddle and the head block is installed and seated. If the buoy is a flat bottom buoy, the buoy is placed upright on



- 
- top of a piece of dunnage.
- m. The buoy is secured to the deck using gripe chains with ratchet load binders or tensors (See **Figure 9-5**). Ratchet tie down straps shall not be used to secure steel buoys larger than 3NR/3CG.
  - n. Once the buoy is secured on deck, the mooring chain shall be disconnected from the buoy at the split key shackle located at the bottom of the swivel. Personnel are not allowed on the buoy until the buoy is securely griped to the deck and the mooring chain is disconnected. (See **Figure 9-6**)
  - o. Prior to performing further work; the buoy port safety chain shall be reconnected.
  - p. The crossdeck line(s) may be slacked or removed. At this point, the buoy is now ready to be cleaned and serviced. Unless the mooring is to be recovered using the mechanical chain stopper or the sinker is to be brought onboard, the lifting sling and crane hook may remain attached to the buoy during servicing. However, in some conditions it may be more desirable to pin the main block or whip hoist to the main deck to prevent movement of these heavy objects and possible movement and damage to the buoy as well.
- 



**Figure 9-5**  
**Gripping Down a Buoy**



**Figure 9-6**  
**Disconnecting the Mooring Chain**

**WARNING** 🖐

**The "horse collar" device on the chain stopper shall be used whenever possible during chain-handling procedures. The collar is designed to keep the chain in the vicinity of the stopper plates. Failure to use this safety device could result in injury to personnel.**





### B.3 Hoisting Chain and Sinker

Once the buoy is secured on deck, the below steps shall be taken to bring chain and the sinker onboard using the chain inhaul winch.

- a. The horse collar is closed on the stopper.
- b. The bitter end of the buoy mooring chain is secured to the chain inhaul winch chain pendant using an alloy-rigging shackle or “Shur-Lok” style alloy hook.
- c. Request from the bridge, “PERMISSION TO HAUL CHAIN.” The bridge will reply, “HAUL CHAIN.” The pelican hook is released. The chain inhaul winch is engaged and the chain is heaved around on to relieve the strain on the chain stopper. The roller sheave is raised, lifting the chain clear of the fixed plate stopper. Before raising the roller sheave, ensure there is no residual slack in the chain to prevent shock loading the level wind arm. The chain is then hauled in with the chain inhaul winch. The level wind device on the chain inhaul winch is used to ensure that the chain does not over wrap itself and is evenly distributed on the drum. For deep water moorings, it may be necessary to station a person behind the inhaul winch with a sledgehammer to seat the wraps of chain securely against themselves to prevent over wrapping or burying the wraps of chain. Avast hauling chain when the chain is at short stay to allow the bridge to obtain a “Found Fix.”
- d. If necessary, request “PERMISSION TO BREAK OUT THE SINKER.” The drum speed will decrease when the chain inhaul winch begins to haul in the sinker. Depending on the size of the sinker and the degree of mud suction, it may be possible for the chain inhaul winch to break the sinker free. If the chain inhaul winch cannot break the sinker free, place the chain in the chain stopper, seat the chain, set the pelican hook, slack the inhaul winch, and break it out with the ship.

#### WARNING

**Always ensure mooring chain is seated in the stopper while using the cutter’s propulsion to break sinkers free. Failure to follow this warning could result in injury to personnel and damage to the cutter’s equipment.**

- e. The mooring chain is hauled in until the sinker is pulled up to just below the water’s edge. Care should be taken to not allow the sinker to strike the hull but to slide alongside it and maintain contact with the hull.

**WARNING** 

**If a sinker in excess of 16,500 pounds is being used or if the buoy has a two sinker mooring, do not lift the sinker out of the water with the inhaul device. Use the main hoist for larger sinkers.**

**WARNING** 

**The crane shall not be used to break out a mudded or sanded sinker. Use the cutter to free the sinker before attempting to hoist with the crane. Failure to follow this warning may result in injuries to personnel or damage to cutter equipment.**

- f. The chain is placed in the stopper by lowering the rising sheave, setting the chain into the throat of the fixed plate stopper. Each time the chain is placed in the stopper plate (See **Figure 9-7**); it shall be seated with a sledgehammer. With the chain locked into the stopper, the chain inhaul winch is slacked off and a pelican hook is set inboard of the stopper.
- g. Request from the bridge, “PERMISSION TO BRING THE SINKER ABOARD” The bridge will reply, “BRING THE SINKER ABOARD.” The crane's hoist is secured to the mooring chain inboard of the stopper using a Modeer shackle or lifting sling.
- h. The horse collar is opened and the pelican hook released. The buoy port safety device (i.e. net, chain, or line) is removed.
- i. Take the weight of the chain and sinker off the stopper with the chain inhaul winch.
- j. The chain is hoisted up and out of the stopper. Raise the chain only high enough to clear the hydraulic stopper. Slack the chain inhaul winch while hoisting, transferring the load completely to the hoist.

**CAUTION !**

**It is not necessary to raise the roller sheave when hoisting the chain clear of the stopper. Raising the sheave in conjunction with hoisting the chain may cause unnecessary damage.**

**WARNING** 

**When hoisting sinkers, the chain inhaul winch must be kept slack, if not, the possibility of the chain jumping off the level wind sheave under tension could result in injury to personnel. The inhaul winch shall not be used as a crossdeck.**



- 
- k. When the sinker is at the sill, place hook of cross deck into the bail of the sinker and take all slack out of the crossdeck. Slew out the crane to form a "V" between the crane and crossdeck. The number and location of crossdeck lines used will vary according to the sea/weather conditions, sinker size and location of placement on the buoy deck.
  - l. Maintaining an outboard lead on the crane and tension with the crossdeck, the sinker is slowly lifted and maneuvered up and over the deck edge to the desired location on the buoy deck. Use the hoist to lift the sinker and the crossdeck to bring the sinker aboard. It should not be necessary to slew the crane until the sinker is on deck. The sinker shall **always** be kept close to the deck.
  - m. The sinker is placed on dunnage and secured to the buoy deck utilizing one gripe for routine servicing and two gripes if the cutter will be transiting with the sinker on deck.
- 



**Figure 9-7**  
**Roller Sheave and Stopper**



**Figure 9-8**  
**Modeer Shackle in Mooring Chain**

---

#### **B.4 Deploying Chain and Sinker**

The following steps shall be used to safely deploy the sinker and chain. These steps require the use of the chain inhaul winch, crossdeck, and hydraulic chain stopper:

- a. The sinker shall be kept securely griped to the buoy deck until the crossdeck line(s) and the hoist hook are fastened.
  - b. Request from the bridge, "PERMISSION TO HANG THE SINKER" The bridge will reply, "HANG THE SINKER." Attach the mooring chain to the sinker. This can be accomplished one of two ways, the end link of the chain can be attached directly to the sinker bale or a pigtail can be created by attaching the mooring chain to the sinker 3 to 5 links up from the end link.
-



- c. The crane hoist is attached to the mooring chain, using a Modeer shackle, rigging shackle, or lifting sling approximately 15-20 links (as applicable) from the sinker bail. (See **Figure 9-8**).
- d. The crossdeck line(s) are secured to the sinker and the slack taken out. Create an opposing lead by slewing the crane outboard.
- e. All sinker gripes and the buoy port safety device are removed.
- f. While maintaining an outboard lead on the boom, the sinker is hoisted and keeping it as close to the deck as possible is slowly moved outboard. The crossdeck line(s) are tended to maintain positive control on the sinker's movement. Once the sinker is clear of the sill, it is lowered below the deck, the boom is swung inboard so that the sinker is kept tight against the hull. The crossdeck line(s) are then removed from the sinker.
- g. Lowering the sinker to just below the inward turn of the hull allows the mooring chain to steadily move forward or aft into the stopper. If a sinker weighs more than 16,500 pounds the crane shall be used to lower the sinker into the water prior to placing the weight of the sinker on the chain inhaul winch. The sinker bail should be at the water's edge. Once the mooring chain is set in the chain stopper, the pelican hook is set and the crane is disconnected from the mooring chain.

### **B.5 Deploying Buoy with Inhaul Winch**

The following method assumes that the buoy mooring chain is secured in the hydraulic chain stopper, the horse collar is closed, the sinker is hanging over the side, and the pelican hook is set.

- a. BDS requests from the bridge, "PERMISSION TO LOWER THE SINKER" The bridge will reply, "LOWER THE SINKER." The pelican hook is released. A strain is taken on the chain with the chain inhaul winch.
- b. The roller sheave is raised, lifting the chain clear of the fixed plate stopper, and the sinker is lowered using the chain inhaul winch until the sinker reaches the bottom. The pilothouse is notified when the sinker touches the bottom and a "Set" fix is obtained.

**NOTE** 

**Ensure the bridge has a good set fix prior to the paying out additional chain.**



- 
- c. Additional chain is paid out until only sufficient chain remains to attach the buoy, normally one (1) complete wrap on the winch drum (approx. 20 ft). The roller sheave is lowered until the mooring chain is positioned in the fixed plate stopper, the inhaul winch is slacked, the chain is seated, and the pelican hook is set.
  - d. The horse collar is opened.
  - e. BDS gives the command to "STRIP CHAIN", the remaining chain is then paid out from the chain inhaul winch and faked out in the buoy port near the chain stopper or forward and aft along the buoy port. The bitter end is detached from the chain inhaul winch pendant.
  - f. The crane hook is placed in the buoy's lifting bail (using the lifting sling or pennant) with the hook opening facing forward if the ship is bow into the current and facing aft if the ship is operating stern to the current. Mouse the hook on the outboard side.
  - g. Swing the crane outboard to establish an opposing lead with the crossdeck.
  - h. Rig the cage line to the buoy cage and crossdeck line(s) are attached.
  - i. When all is ready on deck, the BDS will request permission from the bridge to "SHACKLE AND HANG. The bridge will reply, SHACKLE AND HANG." The safety chain is removed and the buoy end of the mooring chain is attached to the buoy swivel.
  - j. The BDS orders the buoy to be un-griped. When all positions are manned and ready, the buoy is hoisted by the crane, kept as close to the deck as possible and maneuvered to the buoy port.
  - k. The buoy is maneuvered out the buoy port. As soon as the counterweight clears the sill, lower the hoist while simultaneously slewing the crane outboard. Position the buoy body against the sill. Take out any slack remaining in the crossdeck.
  - l. Shift the cage line forward if the cutter is bow into the current, aft if stern to.
  - m. Establish an inboard lead with the crane.
  - n. Simultaneously ease out and up and behind on the crossdeck while heaving around on the cage line.
  - o. The BDS will maneuver the buoy to the aft edge of the buoy port.
-

**NOTE** 

---

**Ensure the buoy stays pinned against the hull while re-positioning.**

---

- p. Un-mouse the crane hoist hook and take the mousing line to a cleat on the aft bulwark.
  - q. Report “READY ON DECK” to the bridge. The bridge will reply “STAND BY”
  - r. Un-mouse the pelican hook and come up on the roller sheave.
  - s. Bridge orders “SET THE BUOY”.
  - t. Lower the buoy and clear the hoist hook, while maintaining positive control of the hoist.
  - u. Trip the pelican hook
  - v. Ease out and „up and behind“ on the cage line.
  - w. BDS reports “BUOY IS AWAY”, replace the buoy port safety device, and secure the hoist.
-



This page intentionally left blank



## Section C. Special Evolutions

---

**Introduction** The following section describes special evolutions that may be encountered during ATON operations. This section covers such things as: working with the mechanical stopper, recovery of sunken hulls, recovery of beached buoys, and recovery of hulls with missing or damaged lifting bails.

---

**C.1 Buoy Operations Without the Inhaul Winch** When use of the chain inhaul winch is not possible or desirable, an alternative method of bringing chain aboard the cutter may be used. This method involves using the crane to hoist staged purchases of chain aboard. The following procedure requires that the chain be secured in the mechanical chain stopper with the horse collar in place. Because of its design the hydraulic chain stopper cannot be used for staged lifts. Buoy mooring chain should be in the "up and down" position and the pelican hook released prior to hoisting chain aboard.

---

- C.1.a Hoisting Chain and the Sinker**
- (1) Once the buoy is secured on deck, the below steps shall be taken to bring chain and the sinker onboard using the mechanical chain stopper and crane.
  - (2) Rig the horse collar, reposition the crossdeck line, and attach a tagline to the end of the chain.
  - (3) Request from the bridge, "PERMISSION TO PULL CHAIN", the bridge will reply, "PULL CHAIN."
  - (4) Once permission is granted, spot the crane slightly inboard of the chain stopper, hook the appropriate purchase into the chain just inboard of the chain stopper, and trip the pelican hook.
  - (5) Commence pulling chain after alerting the crew: "STAND CLEAR; PULLING CHAIN". When the hoist is nearly two-blocked, the chain is seated in the stopper by striking it smartly with a sledge hammer.
  - (6) Once the chain is seated in the stopper, fake the chain athwartships in the buoy port as the hoist is lowered. As soon as practical, secure a bight of chain in the pelican hook.
  - (7) Repeat steps (5) and (6) until the desired length of chain has been pulled aboard or until the sinker is a short stay.
  - (8) If the sinker is to be brought onboard, notify the bridge the buoy is at
-





---

short stay and continue with steps (5) and (6) until the sinker is at the water's edge.

- (9) Request from the bridge, "PERMISSION TO BRING THE SINKER ABOARD" The bridge will reply, "BRING THE SINKER ABOARD."
- (10) The crane hoist is secured to the buoy chain inboard of the stopper using a Modeer shackle, rigging shackle, or lifting sling and the horse collar is removed.

**WARNING**

**The crane shall not be used to break out a mudded or sanded sinker. Use the ship to free the sinker before attempting to hoist with the crane. Failure to follow this warning may result in injuries to personnel or damage to the cutter's equipment.**

- (11) Without raising the sinker above deck level and keeping the sinker tight against the side of the ship, the chain and sinker are hoisted and maneuvered to the center of buoy port. Crossdeck line(s) shall then be attached to the sinker. The number and location of crossdeck lines used will vary according to the sea/weather conditions, sinker size and location of placement on the buoy deck.
- (12) Maintaining an outboard lead on the crane and tension with the crossdeck, the sinker is slowly lifted and maneuvered up and over the deck edge to the desired location on the buoy deck. The sinker shall be kept close to the deck.
- (13) The sinker is placed on dunnage and secured using at a minimum one gripe rove through the sinker bail. Additional gripes may be required given weather conditions, transit requirements, or weight handling activities.

**C.1.b  
Deployment of  
Sinker**

---

If using the staged lift method (no inhaul winch), fake the chain between the deck edge and bull chain. Secure bites of chain using rotten stops to the bull chain. At least one bite of chain shall be secured to the deck with a pelican hook. This will ensure that the chain will not run overboard when the sinker is lowered over the side.

The following steps shall be used to safely deploy the sinker:

- (1) The sinker shall be kept securely griped to the buoy deck until the crossdeck line(s) and the hoist hook are fastened.
  - (2) Request from the bridge, "PERMISSION TO HANG THE SINKER"
-



---

The bridge will reply, "HANG THE SINKER." Attach the mooring chain to the sinker using a pigtail. Create the pigtail by attaching the mooring chain to the sinker 3 to 5 links from the end link.

- (3) The crossdeck line(s) are secured to the sinker and the slack taken out. Create an opposing lead by slewing the crane outboard.
  - (4) The crane hoist is attached to the end link of the mooring chain.
  - (5) Establish an opposing angle between the crossdeck and crane, by swinging the crane outboard. Ensure the angle on the crane is sufficient enough to maintain an outboard angle while the sinker is being positioned over the side.
  - (6) All sinker gripes and the buoy port safety device are removed.
  - (7) While maintaining the outboard lead and keeping the sinker as close to the deck as possible, ease out on the crossdeck until the sinker is clear of the sill.
  - (8) Once the sinker is clear of the sill the BDS should lower the sinker until it is nearly level with the sill, heave around on the crossdeck pinning the sinker against the hull and swing the crane inboard until an inboard lead is established.
  - (9) Ease out and slack the cross deck line(s).
  - (10) The BDS maneuvers the chain into the chain stopper, ensuring that an inboard lead is maintained on the crane to keep the sinker in contact with the hull. This angle may have to be exaggerated in a heavy sea.
  - (11) Once the sinker is outboard of the mechanical chain stopper, the mooring chain should be placed in the stopper by use of chain hooks or a boat hook.
  - (12) Seat the mooring chain in the stopper with a sledge hammer and set the pelican hook.
  - (13) Clear the hoist hook.
- 

**C.1.c Setting the Sinkers and Buoy using the Mechanical Stopper**

The following method assumes that the sinker is suspended from the mechanical chain stopper, the mooring chain is faked out between the sill and bull chain. The mooring chain shall be made off to the bull chain with rotten stops. Two pelican hooks will be utilized for this evolution, one forward of the bull chain for the buoy and one aft of the bull chain as a

---



---

safety device for the mechanical stopper.

- (1) The crane hoist hook is placed in the buoy's lifting bail (using the synthetic lifting sling or pennant) with the hook opening facing forward if the ship is bow into the current and facing aft if the ship is operating stern to the current. Mouse the hook on the outboard side.
- (2) The cage line is rigged to the buoy cage and crossdeck line(s) are attached.
- (3) When all is ready on deck, request permission from the bridge to "SHACKLE AND HANG. The bridge will reply, SHACKLE AND HANG." The buoy port safety device is removed and the buoy end of the mooring chain is attached to the buoy swivel.
- (4) Slew the crane outboard to establish an opposing lead with the crossdeck.
- (5) The buoy is un-griped. When all positions are manned and ready, the buoy is hoisted by the crane, kept as close to the deck as possible and maneuvered to the buoy port.
- (6) The buoy is maneuvered out the buoy port. As soon as the counterweight clears the sill, come down on the hoist while simultaneously slewing the crane outboard. Position the buoy body against the sill. Take out any slack remaining in the crossdeck.
- (7) Shift the cage line forward if the cutter is bow into the current, aft if stern to.
- (8) Establish an inboard lead with the crane.
- (9) Simultaneously ease out and up and behind on the crossdeck while heaving around on the cage line.
- (10) The BDS will maneuver the buoy aft of the buoy port.

**NOTE** 

**Ensure the buoy stays pinned against the hull while re-positioning.**

- (11) Unmouse the crane hoist hook and hand-tend the mousing line or take the line to a cleat if available.
  - (12) Clear the aft pelican hook.
  - (13) Report "READY ON DECK" to the bridge. The bridge will reply "STAND BY".
-



- 
- (14) Unmouse the forward pelican hook and clear the pin from mechanical chain stopper.
  - (15) Bridge orders "SET THE BUOY".
  - (16) Trip the mechanical chain stopper.
  - (17) Lower the buoy and clear the hoist hook, while maintaining positive control of the hoist.
  - (18) Trip the forward pelican hook.
  - (19) Ease out and „up and behind“ on the cage line.
  - (20) Report "BUOY IS AWAY", replace the buoy port safety device, and secure the hoist.
- 

### **C.2 Recovery of a Sunken Buoy**

All buoy tenders are called upon from time to time to drag for and recover sunken buoys. In the past, this was a slow, tedious and oftentimes ineffective process. With the incorporation of the Differential Global Position System (DGPS) into the buoy positioning process, coupled with electronic charting, the probability of successfully locating sunken buoys has significantly increased. The use of side scan sonar is also an option in locating sunken buoys, especially on flat bottoms.

The overall evolution of locating and recovering sunken buoys is typically broken down into three separate phases; (1) Dragging operations, (2) Snagging a submerged object, – ideally the sunken buoy – recovering the grapnel hook, and determining what has been snagged, and (3) Recovering the buoy and sinker.

### **CAUTION!**

**Due care must be exercised to ensure that there are no underwater obstructions in the immediate area prior to commencing any dragging operations. Dragging operations shall not be conducted in cable crossings or restricted areas.**

**CAUTION!**

**Ensure that the sunken weight of the buoy to be recovered does not exceed the WLL of the cutter's crane. If the weight does exceed the WLL of the crane, water shall be drained from the hull before being brought completely clear of the water's edge and before being brought onboard. Consult tables 2-7 and 2-8 in the Aids to Navigation Manual - Technical (COMDTINST M16500.3 (series)) for specific flooded buoy weights.**

**C.2.a Setting Up the Deck for Dragging**

The grapnel hook – sometimes referred to as an anchor hawk – is an integral piece of gear used in the recovery of sunken buoys. Before deploying the grapnel hook however, the deck must be made ready to receive the sunken buoy and mooring. These preparations include but are not limited to: staging deck winches, tag lines, gripes, oxygen/acetylene or exothermic torch, and other appropriate tools and equipment.

**C.2.b Hanging the Grapnel Over the Side**

The following steps are the steps for hanging the grapnel using the chain inhaul winch method. This method utilizes both the forward and aft chain stopper, and if available, two crossdecks and a forward and aft led hogging line.

- (1) Spool enough buoy chain on the inhaul winch to allow for a drag chain with a scope between 1:3 to 1:5 the depth of water.
- (2) Attach the grapnel to the bitter end of the chain.
- (3) Connect a sling to the chain approximately 15 to 20 links below the grapnel.
- (4) Attach the sling to the crane hoist.
- (5) Attach a crossdeck to the lifting eye of the grapnel.
- (6) Request "PERMISSION TO HANG THE GRAPNEL."
- (7) When the bridge orders "HANG THE GRAPNEL," hoist the grapnel and slew outboard of the sill. Pay out on the crossdeck as needed to keep the grapnel hook steady. Once the grapnel is outboard of the sill, come down on the hoist hook until the grapnel is below the sill. Slew the crane inboard and pin the grapnel against the side of the ship.
- (8) Slack out and up behind on the crossdeck.
- (9) Maneuver the crane until the drag chain is even with the forward chain stopper. Using chain hooks, place the chain in the stopper, come down on the hoist until slack, seat the chain with a



---

sledgehammer, and set the pelican hook.

- (10) Slack and clear the hoist hook. Slew the crane inboard and secure the hoist hook to a deck padeye, ensuring that the hoist hook is clear of the working area of the deck.
- (11) Set the horse collar.
- (12) Heave around on the inhaul winch until all slack is removed from the drag chain.
- (13) Request "PERMISSION TO LOWER THE GRAPNEL." The bridge will order, "LOWER THE GRAPNEL."
- (14) Raise the roller sheave and lower away on the inhaul winch until you have enough chain over the side to facilitate dragging. Lower the roller sheave; set the chain with a sledgehammer, and attach the pelican hook inboard of the stopper. Slack the inhaul until all strain is off of the inhaul winch.
- (15) Ensuring that all hands are in a safe location, pass "READY ON DECK" to the bridge. The bridge will begin dragging operations.

**NOTE** 

**The conning officer should keep slight way on when the grapnel hook is deployed to avoid having the chain pile atop the grapnel hook.**

**C.2.c Conning Tips**

The following conning tips may facilitate the safe and successful recovery of a sunken buoy and its mooring:

- (1) The search area parameters can be marked either electronically via the Electronic Chart System (ECS), by outlining the area with marker buoys, or by employing both methods.
- (2) In areas with a predominate current, the buoy and its mooring will typically lay parallel to the current either up or down stream from the buoy's assigned position. Dragging across this line produces the strongest possibility of successfully snagging the sunken buoy or its mooring chain.
- (3) As with every evolution involving ship handling, the current should be used to your best advantage. Stemming the current and either thrusting perpendicular to the current or crabbing 10 to 15 degrees to each side across the current while moving upstream at the end of each pass will increase the probability of success.



- 
- (4) If you're initially unsuccessful, try a sector search pattern with AP as the center of datum.
  - (5) One of the more common mistakes committed when dragging for a sunken buoy is excessive speed of advance, i.e. towing the grapnel hook too fast, which causing it to bounce along the bottom. The chances of recovering a sunken buoy or its mooring are significantly reduced when the grapnel hook is not in contact with the bottom.
  - (6) The conning officer must be always be acutely aware of the ship's proximity to shoal water, obstructions, and other hazards.
- 

### **C.2.d Retrieving a Snagged Object**

When a grapnel hook fetches up on an underwater object – hopefully the sunken buoy or its mooring – there remains a degree of uncertainty as to what has been actually snagged. For example, while dragging for a 3CR with a single mooring, you may have actually hooked into a 2CR with a double mooring. Therefore, safe and successful recovery of a sunken buoy requires sound rigging practices, patience, ingenuity, and close coordination between the conning officer and buoy deck.

- (1) If available, rig two crossdecks, and two hogging lines; one fore and aft of the buoy port. Rig an additional pelican hook near the aft chain stopper. Have your cutting outfit rigged and ready to cut the mooring chain, and if required, a hole in the buoy to drain water.
  - (2) Contact the bridge as soon as it's apparent that the grapnel hook has fetched up on a submerged object. The conning officer should maneuver the ship to keep a slight strain on the grapnel while the deck prepares recovery operations.
  - (3) Request "PERMISSION TO HEAVE AROUND." The bridge will order "HEAVE AROUND." Heave around on the inhaul and take out the slack in the chain, trip the pelican, come up on the roller, heave around on the inhaul and begin recovering the drag chain.
  - (4) Maintain constant communications with the bridge as the chain is recovered. The conning officer should strive to keep the chain slightly outboard until the grapnel breaks the surface. As soon as the grapnel breaks the surface, lower the roller and place the chain in the stopper. Set the chain with a sledgehammer and attach the pelican hook.
-

**NOTE** 

**If at any time during the recovery of the drag chain the inhaul winch stalls out, place the chain in the stopper and make preparations to recover using the crane hoist.**

- (5) Place a properly rated lifting sling into the drag chain between the pelican hook and forward stopper.
- (6) Spot the hoist over the sling. Connect the hoist to the sling. Clear the horsecollar. Take a strain on the inhaul winch and trip the pelican.
- (7) Request, "PERMISSION TO BRING THE GRAPNEL ABOARD." The bridge will reply, "BRING THE GRAPNEL ABOARD."
- (8) Come up on the roller. Take a strain on the hoist and slowly pay out on the inhaul until the hoist has the full load. Have the crane operator check the weight of the load. If the weight is within the WLL of the crane, maneuver the crane until the grapnel is pinned against the side of the ship and in the center of the buoy port. If the weight exceeds the WLL of the crane, immediately place the drag chain back into the chain stopper, set the chain, and attach the pelican hook. Discuss possible options with the bridge, including releasing the mooring in a safe location.
- (9) Raise the load high enough to attach a crossdeck into the lifting eye of the grapnel. Take the slack out of the crossdeck.
- (10) Lift the grapnel high enough to clear the sill. Heave around on the crossdeck until the grapnel is safely on deck. Because of the strain on the grapnel, it may also be necessary to boom in while heaving around on the crossdeck.
- (11) Place the second crossdeck into the forward bight of mooring chain and heave around until both the strain is relieved from the grapnel and there is enough slack in the mooring chain to hog it into the forward chain stopper.

**WARNING** 

**Both legs of the mooring chain are considered LIVE CHAIN – Allow no one to step on or move outboard of this chain. Handle chain with chain hooks, NOT HANDS!**

- (12) Hog this forward bight of chain into the forward chain stopper.





---

Set the chain and attach the pelican.

- (13) Clear the first crossdeck and re-rig it into a bite of the aft mooring chain. Heave around on the crossdeck until there is enough chain to hog this aft section of mooring chain into the aft chain stopper.
- (14) Hog the chain into the aft stopper and attach the pelican hook. Clear the crossdecks.
- (15) Recover the grapnel. It may be necessary to cut the mooring chain to facilitate freeing the grapnel. Move the grapnel out of the working area of the deck and gripe it down.

**NOTE** 

**At this point a decision has to be made about the drag chain on the inhaul winch. This chain can either be left on the drum or stripped off. This decision should be based upon the length of the mooring to be recovered. If the moor is long, be sure to strip the drag chain first.**

- (16) Cut the mooring chain between the forward and aft stoppers. Set the horsecollar on the forward chain stopper. Take the bitter end of the forward section of mooring chain to the inhaul winch.
  - (17) Request "PERMISSION TO RECOVER THE FORWARD CHAIN." The bridge will reply, "RECOVER THE FORWARD CHAIN."
  - (18) Heave around on the inhaul until the slack is taken out of the mooring chain. Trip the forward pelican. Raise the roller and heave around on the inhaul winch.
  - (19) If the sinker is attached to the forward mooring chain, recover it on deck following standard sinker recovery methods. Move the recovered sinker out of the working area and gripe.
  - (20) If the buoy is attached to the forward mooring chain, stop recovering chain as soon as any lifting bale on the buoy breaks the surface. Raising the buoy completely out of the water with the inhaul winch may exceed its WLL.
  - (21) Lower the roller, set the chain, and attach the pelican hook.
  - (22) Raise the horsecollar. Spot the hoist over the forward chain stopper. Ensure that there is sufficient slack in the crossdecks for the hooks to reach outboard of the buoy port.
-

**WARNING** 

**Discuss the WLL of the crane with your crane operator. Remind the operator to watch the weight of the load throughout the operation.**

- (23) Rig a lifting sling into the most available lifting bale on the buoy. Take whatever bale is available. Sometimes this means a bale on the bottom of the buoy. Attach this sling to the hoist hook.
- (24) Request “PERMISSION TO BRING THE BUOY ABOARD.” The bridge will reply, “BRING THE BUOY ABOARD.”
- (25) Take the slack out of the inhaul winch. Leave the roller down and continue to come up on the load until the mooring chain has some slack. At this point raise the roller and maneuver the buoy to the center of the buoy port. Slowly raise the load; continually monitoring the weight of the flooded buoy.

**NOTE** 

**The evolution may have to pause to allow time for the water to drain out of the buoy. If the water isn’t draining or is draining slower than is preferred, it may be necessary to cut a drain hole in the buoy. If the weight of the flooded buoy is within the WLL of the hoist, it may be immediately recovered on deck.**

**NOTE** 

**Employing a long cutting apparatus will enable personnel to decrease the buoy’s sunken weight by cutting a drain hole in the buoy hull before its entire weight is bore by the vessel’s weight handling gear. Although outfitted with less reach than the above torch, an Exothermic cutting torch is typically faster and is effective with the cutting rod underwater.**

- (26) Keeping the buoy tight against the ship, slowly raise the buoy until a crossdeck can be attached. Take the slack out of the crossdeck and slew the crane slightly outboard. If possible rig a cage line.

**NOTE** 

**If the buoy is to be brought aboard upside-down and backwards, deploy the head block and the buoy saddle in the working buoy port – opposite of its normal position.**



- 
- (27) Continue to raise the buoy until it clears the sill. Heave around on the crossdeck and keep the slack out of the inhaul winch all while slowly slewing the crane inboard. Keep the load as low as possible and bring the buoy aboard.
  - (28) Once the buoy is aboard, hog the chain into the forward stopper, set the chain, and attach the forward pelican hook. Follow normal buoy securing procedures (saddle and headblock or dunnage, and gripes)
  - (29) Disconnect the mooring from the buoy and prepare to recover the remaining mooring utilizing the inhaul winch. Request "PERMISSION TO HAUL CHAIN." The bridge will order, "HAUL CHAIN." Take the slack out of the inhaul, trip the pelican, come up on the roller, and bring the remaining chain aboard.
- 

### C.3 Recovery of Buoys Ashore

A buoy tender may be called upon to recover a buoy that has washed ashore. Typically a shore party is debarked to assess the buoy's condition. The shore party's primary missions are to ensure:

- a. That the buoy's structure is sound and that it will not sink during towing operations.
- b. That the buoy is disconnected from its mooring and free from any obstructions that would hinder the towing operation.
- c. That the towline is properly rigged. The towline shall be of sufficient size and strength and is attached to one of the buoy's lifting bails.

Once the buoy has been properly rigged for towing, the buoy is towed out into the water either by ship's propulsion or taken to power with a capstan or gypsy head.

#### NOTE

**The vessel's towing bill and appropriate safety procedures shall be followed during towing operations.**

---

When the buoy is towed into an area deemed safe for recovery by the Commanding Officer, then the buoy is retrieved using the procedures outlined in paragraph B.3 of this chapter. The vessel's towing bill and appropriate safety procedures shall be followed during towing operations.

---

**NOTE** 

**When transitioning from the towing bill to the ATON bill, the towline shall be constantly tended by competent personnel to ensure that the towline does NOT become fouled with the vessel.**

**C.4 Damaged Lifting Bails**

Recovering unlighted nuns and cans whose lifting bails have been damaged is accomplished using a lasso. A lasso is rigged using a rated eye-and-eye or endless sling. The following are some general procedures for recovering buoys with damaged or missing lifting bails:

- a. The lasso is slung around the buoy hull; boat hooks are used to work the lasso into place. One end of the sling should be placed on the hoisting purchase or otherwise secured on deck.
- b. Once the lasso is around the buoy hull and attached to the hoisting purchase, the hoist is lowered so that the lasso will work its way below the buoy hull and cinch up on the mooring.
- c. The lasso will take hold of the mooring just below the buoy and as it is raised will pick up the buoy upside down. The buoy is then brought on board. Because the buoy is upside down, control on deck is very limited. Typically a crossdeck is attached to the buoy mooring bail to help control the buoy and guide it into the buoy saddle.
- d. The mooring chain is hogged into the stopper, the pelican hook is set, the buoy is griped, and mooring disconnected.

**CAUTION!**

**The lasso should not be used as a choker around the buoy body due to the potential for slipping. Ensure that the lasso cinches around the mooring chain.**



This page intentionally left blank



## Chapter 10

# Inland Buoy Tender Operations

---

### Introduction

This chapter presents an overview of weight handling operations aboard the 65 and 100 foot classes of Inland Buoy Tenders (WLI). This chapter is not intended to cover all weight handling situations that these vessels might encounter in the course of executing Coast Guard missions. However, the safety rules, standard evolution procedures, and sound seamanship practices shall be followed whenever engaged in any ATON or weight handling evolution.

---

### In this chapter

This chapter contains the following sections:

Section	Topic	See Page
A	General Information	10-3
B	Standard Buoy Evolution	10-5
C	Special Evolutions	10-11

---



This page intentionally left blank



## Section A. General Information

**Introduction** There are two classes of WLI, the 100' WLI (BUCKTHORN and BLUEBELL) and the 65' WLI (BAYBERRY and ELDERBERRY). The SMILAX, which is classified as a WLIC, has a boom on the cutter that it uses to service buoys when detached from its barge.

### A.1 100' WLI Crane Information

BUCKTHORN has an Appleton model SB-20-30 hydraulic crane with the characteristics described in section A.1.a and the BLUEBELL has an Allied Marine Crane, characteristics are below in section A.1.b.

#### A.1.a BUCKTHORN Crane Characteristics

Maximum Swing Range	360 degrees
Maximum WLL (Main)	10,000 lbs
Maximum WLL (Whip)	2,000 lbs
Boom Reach (max outreach)	26'
Wire Rope (Main)	150' of 1/2" 6x36 RRL XIP IWRC
Wire Rope (Whip)	100' of 3/8" 6X36 RRL XIP IWRC

#### A.1.b BLUEBELL Crane Characteristics

Maximum Swing Range	360 degrees
Maximum WLL (Main)	10,000 lbs
Maximum WLL (Whip)	2,000 lbs
Boom Angle (min/max)	0 - 75 degrees
Boom Reach (max out reach)	36'
Wire Rope (Main)	190' of 1/2" 6x36 RRL XIP IWRC
Wire Rope (Whip)	125' of 3/8" 6X36 RRL XIP IWRC

### A.2 65' WLI Crane Information

The ELDERBERRY and BAYBERRY have a hydraulic boom with a lift capacity of 4,000 lbs.

#### A.2.a Crane Characteristics

Maximum Swing Range	360 degrees
Maximum WLL (Main)	4000 pounds
Boom Angle (min/max)	0 - 75 degrees
Boom Reach	Fixed – 19 feet
Boom Height (max)	21 feet at 75 degrees
Wire Rope (Main)	120' of 1/2" 6X37 RRL XIP IWRC





---

**A.3 Crossdeck  
Winch  
Information**

The WLI fleet is outfitted with a variety of non-standard crossdeck winches, too many to list. Personnel should refer to the applicable technical manual to obtain the details of the crossdeck winches for their respective cutter configuration.

---

**A.4 Spuds**

The BUCKTHORN is equipped with one (1) 25 foot x 12 inch square steel spud. The BUCKTHORN is the only WLI with a spud.

---



## Section B. Standard Buoy Evolution

---

**Introduction** Inland buoy tenders are equipped with either a crane or boom, which is used to hoist buoys, sinkers, and chain aboard the vessel. Prior to executing any buoy deck operations, all weight handling gear shall be inspected and exercised.

---

**B.1 Planning and Preparation** Conduct a briefing before beginning any buoy deck evolution. Follow the procedures outlined in Appendix I of this manual for the required content to be discussed at this briefing.

---

**B.1.a Buoy Deck Set up** After the briefing session complete the following:

- (1) Energize all appropriate deck equipment. Ensure all buoy weight handling equipment including crane/boom, deck winches, chain stopper and gripes are inspected and exercised to ensure proper operation. Permission should be requested from the bridge prior to exercising the crane. Also, document the inspection of equipment on a Daily Inspection Log.
- (2) Rig the bull chain, pelican hooks, snatch blocks, and other applicable deck gear and tools.
- (3) Rig a deck winch to hog chain into the desired chain stopper.
- (4) Rig cross-deck(s) and fairlead blocks for horizontal control of the load.
- (5) Position head blocks, saddles and/or dunnage to receive the buoy.
- (6) Slew the crane/boom outboard toward the center of the working buoy port and spot the hook.
- (7) Remove the appropriate stanchions and lifelines located in the working buoy port. Ensure that the safety chain is rigged.
- (8) After all gear has been exercised, the appropriate tools have been staged and all personnel are ready, the Buoy Deck Supervisor (BDS) or Safety Supervisor shall notify the bridge: "READY ON DECK."

---

**B.2 The Approach** Ship handling, specific to working alongside buoys, is covered in Chapter 8 of this manual. The conning officer will inform the BDS or Safety Supervisor whether the buoy will be approached on the port or starboard side. This decision is typically dependant upon environmental conditions, deck space availability, and cutter practices.

---



### B.3 Hoisting the Buoy Aboard

The following is the standard evolution for hoisting lighted and unlighted buoys aboard Inland Buoy Tenders.

- a. The bridge will give permission to the buoy deck that it is safe to begin the buoy evolution by passing to the BDS or Safety Supervisor: "HOOK IT WHEN YOU CAN." On lighted buoys and larger unlighted buoys, a cageline is passed and tended from the forward part of the buoy deck on the BLUEBELL and aft on the BUCKTHORN. The cage line steadies the buoy alongside the buoy port facilitating reeving the hoisting hook
- b. Reeve the main or auxiliary hoist's hook into the appropriate buoy lifting bail. (See **Figure 10-1**)

#### NOTE

**Typically a synthetic sling or picking pennant is rove through the buoy lifting bail and secured on the main or auxiliary hoist's hook.**

- c. Mouse the hook and/or picking pennant once the buoy is hooked.

#### WARNING

**Mechanical mouse systems shall not be used on the hook that is connected to the buoy lifting bail.**

- d. When the hook is moused and all personnel are clear, remove the safety chain, hoist the buoy and ease the cage line as necessary until the buoy swings inboard.
- e. Lower the buoy hull until it is slightly above the buoy deck sill. Hook the cross-deck line into the appropriate buoy lifting bail to limit the buoy's horizontal movement and to assist the crane/boom in slewing the buoy across deck.
- f. Keep tension on the cross-deck line and shift the cage line to the opposite bulwark/buoy port. Use a combination of the cross-deck line and the crane/boom to safely maneuver the buoy across the deck – **keeping it low to the deck** – until it's in position to be lowered into the saddle or onto dunnage.

**NOTE** 

The cross-deck line and crane boom should be handled in a way as to provide opposing forces on the buoy as it is slewed across the deck. The cage line controls the buoy cage on lighted buoys and together with the cross-deck line and crane boom controls the buoy until it is maneuvered into the saddle (or onto the applicable dunnage for flat bottom buoys) and secured on deck via the appropriate gripe-down gear.

**WARNING** 

When a mooring chain is leading over the buoy deck sill, all personnel should remain alert for a sudden movement of the chain due to unplanned cutter movement.

- g. Reeve the hogging line hook into the buoy mooring chain near the mechanical chain stopper. Heave around on the hogging line until the chain is in the mechanical chain stopper. Seat the chain in the stopper by striking it smartly with a sledge hammer. (See **Figure 10-2**)



**Figure 10-1**  
Hooking into the Buoy



**Figure 10-2**  
Setting the Chain into the Stopper

**CAUTION!**

Ensure that the hogging line hook is reeved so that the tip of the hook is pointing up to prevent it from falling out of the chain or from snagging on deck obstructions. Also, slings or Modeer shackles may be necessary when hooking into smaller mooring chain to avoid point loading the hook.



- h. Once the chain is set in the chain stopper, slack the hogging line, remove it from the mooring chain, and set the pelican hook.
- i. Lower the buoy into the saddle then set and seat the head block.
- j. When the buoy is in the saddle and the head block seated, secure it to the deck with the appropriate size and number of gripe chains and ratchet binders.

**WARNING** 

**Strap-type load binders SHALL NOT be used to secure steel buoys larger than 3<sup>rd</sup> class unlit buoys.**

- k. After the buoy is properly griped, disconnect the mooring chain from the buoy and ensure the safety chain is rigged. (See **Figure 10-3**)

**WARNING** 

**Personnel are not allowed on the buoy until the buoy is securely griped to the deck and the mooring chain is disconnected OR whenever pulling chain.**

- l. Once the buoy is properly secured on deck, the cross-deck line may be slacked or removed - the buoy is now ready to be serviced. Remove the hoisting purchase from the buoy and ensure that it's properly secured.

**B.4 Pulling Buoy Chain**

There are several reasons for pulling chain including to: facilitate resetting the buoy, inspect the mooring chain chafe section, verify position (pulling to short stay), inspect the sinker, etc. Hoisting buoy chain aboard a WLI involves using the crane/boom to make a series of lifts until the desired length of buoy chain is aboard. The following is the standard evolution for pulling buoy chain.

- a. Rig the horse collar, reposition the crossdeck line, and attach a tagline to the end of the chain.
- b. Request from the bridge, "PERMISSION TO PULL CHAIN" The bridge will reply, "PULL CHAIN." (See **Figure 10-4**).
- c. Once permission is granted, spot the crane/boom slightly inboard of the chain stopper, hook the appropriate purchase into the chain just inboard of the chain stopper, and trip the pelican hook.

**NOTE** 

**For large size chain, the hook may be inserted directly into a chain link. For smaller sizes of chain use either a safety shackle of appropriate size, a Modeer shackle, or sling (chain or synthetic) to connect the hook into the chain.**



**Figure 10-3**  
Breaking the Buoy

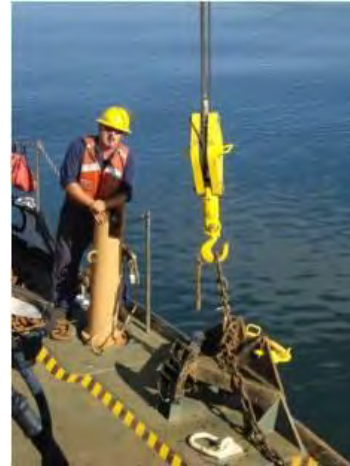

**Figure 10-4**  
Preparing to Pull Chain

- d. Commence pulling chain after alerting the crew: “CLEAR THE DECK; PULLING CHAIN”. When the desired length of chain is pulled or when the hoist is NEARLY two-blocked, hook the crossdeck into the chain approximately 2-3 feet above the stopper. Heave around on the crossdeck until the chain is sufficiently led into the stopper jaws and then lower the hoist so that the chain is properly set in the stopper – the chain is seated by striking it smartly with a sledge hammer.
- e. Once the chain is seated in the stopper, fake the chain down in the buoy port as the hoist is lowered. As soon as practical secure a bight of chain in the pelican hook.
- f. Repeat steps (4) and (5) until the desired length of chain has been pulled aboard or until the sinker is a short stay (See **Figure 10-5**).

**NOTE** *↪*

**Permission must be obtained from the bridge PRIOR to breaking out the sinker from the bottom.**

- g. If it is necessary to lift the sinker off the bottom, then continue with steps (4) and (5) until the sinker is at the water’s edge.

**CAUTION!**

**In some cases the hoisting purchase alone may not be able to break a sinker free from the bottom. In those cases, secure the mooring chain in the chain stopper and set a pelican hook. Maneuver the vessel around the mooring until the sinker is broke free from the bottom. Once the sinker is free commence pulling chain by repeating steps (4) and (5).**



**Figure 10-5**  
**Pulling Chain**

- h. Remove the horse collar once the desired length of chain has been pulled aboard or when the sinker is at the water's edge.

### **B.5 Bringing the Sinker Aboard**

Handling sinkers in a dynamic environment can be one of the most dangerous weight handling evolutions for a WLI. A successful and safe evolution requires close coordination between the conning officer and buoy deck to provide the most stable platform possible in the existing environmental conditions. The following is the standard evolution for bringing the sinker aboard.

#### **NOTE**

**Permission must be obtained from the bridge PRIOR to bringing the sinker on deck.**

- a. Stage the appropriate dunnage, gripe down gear, crossdeck(s) and necessary steadying lines (large taglines) for the sinker.
- b. Hook the hoisting purchase into the chain inboard of the chain stopper jaws, mouse the hoisting hook, hook the crossdeck into the chain below the hook, and remove the horse collar.
- c. Drop the safety chain and then lift the chain out of the chain stopper. Once the chain is clear of the stopper, maneuver the crane/boom so that the sinker is slid slightly aft of the chain stopper and is tight against the hull. Slowly hoist the sinker until an aft steadying line or 2<sup>nd</sup> crossdeck can be safely attached to the sinker.

**WARNING** 

**The entire length of the mooring chain attached to the sinker is considered LIVE CHAIN – Allow no one to step on or move outboard of this chain. Handle chain with chain hooks, NOT HANDS!**

- d. Once all of the necessary steadying lines are attached, put all steadying lines under tension and position the crane/boom tip slightly outboard of the sinker bail. Hoist the sinker until it is slightly above the buoy port sill.
- e. Heave around the crossdeck(s) and slew the crane/boom as the sinker slowly moves across the deck. Keep the crane/boom slightly outboard of the sinker bail and ensure that the steadying lines are kept taut. Walk the sinker until it is at the pre-staged area of the deck.

**NOTE** 

**As with moving a buoy it is important to maintain a “V” with the crane and the cross-deck.**

- f. Slowly lower the sinker on the pre-staged dunnage and gripe it in place using at least two (2) separate gripe chains.
- g. Rig the safety chain.

**B.6 Hanging the Sinker**

The following is the standard evolution for hanging the sinker.

- a. Attach the mooring chain to the sinker, rig appropriate crossdeck(s) and steadying lines. Hook the hoisting purchase into the pigtail.

**NOTE** 

**Attach the buoy mooring chain to the sinker so that a “pigtail” is created. This is accomplished by shackling a bight of chain (3 to 5 links from the end link) to the sinker bail. The shackle clevis is passed through the sinker bail so that the shackle pin will pass through the chain link. The chain link should be “tumbled” in such a way as to ensure that the chain link leading to the buoy will not pinch against the link leading to the pigtail.**

- b. Fake the mooring chain in the buoy port with a bight secured in a pelican hook. Ensure that there is sufficient slack in the chain to allow the sinker to be moved outboard and lowered into the stopper. On longer moorings, rotten stop and rigging a second pelican hook may be necessary. The sinker remains securely griped to the deck until permission is obtained to hang the sinker.





- c. Request “PERMISSION TO HANG THE SINKER” from the bridge. The bridge will reply, “HANG THE SINKER.”
  - d. Put all crossdeck(s) and steadying lines under tension and position the crane/boom tip slightly outboard of the sinker bail.
  - e. Remove the sinker gripes and drop the safety chain.
  - f. Lift the sinker until is slightly above the buoy deck. While keeping the crossdeck(s) and steadying lines taut, slowly maneuver the crane/boom outboard and walk the sinker slowly until it is clear of the buoy sill. Lower the sinker just below the deck edge keeping it snug against the hull.
  - g. Maneuver the sinker forward keeping it snug against the hull until the chain is in position to be set in the chain stopper.
  - h. Seat the chain in the stopper, remove the crossdeck(s), steadying lines, and the hoisting purchase.
  - i. Rig the safety chain.
- 

### B.7 Setting the Sinkers and Buoy

The following procedure assumes: (1) The mooring chain is in the chain stopper and the sinker is either suspended or on the bottom, (2) The mooring chain is faked out athwartships in the buoy port with the bights rotten stopped to the bull chain, (3) A pelican hook is rigged (typically aft in the buoy port) with enough chain between the pelican hook and the buoy to facilitate shackling and hanging the buoy.

---

#### NOTE

**Ensure the hoisting purchase is hooked into the appropriate buoy bail with the hook opening facing forward and moused opposite of the working buoy port.**

---

- a. Hook the hoisting purchase into the appropriate buoy bail, rig the crossdeck(s) and the cage line (for lighted and large unlighted buoys). Ensure that all of the necessary tools and equipment (split key hammer, sledge hammer, shackle, pin, split key, etc.) are staged for shackling the mooring to the buoy and that all positions are properly manned.
  - b. Request, “PERMISSION TO SHACKLE AND HANG” from the bridge.
  - c. Once permission is obtained, attach the mooring chain to the buoy, remove the buoy gripes, and drop the safety chain.
  - d. Ensure that all buoy deck personnel man their respective positions and
-



- 
- inform the buoy deck supervisor that their position is manned and ready. For example; “CAGELINE MANNED AND READY.”
- e. With a slight outboard lead and the steadying lines (cage and crossdeck) taut, the buoy is hoisted and maneuvered toward the working buoy port, under control of the steadying lines and keeping the buoy as low to the deck as possible.
  - f. When the buoy’s counterweight is clear of the buoy deck sill, lower the buoy until the counterweight is below the deck level. Slew the crane/boom slightly inboard to keep the buoy snug against the hull.
  - g. For unlighted buoys: Continue lowering the buoy over the side until it is at the desired height for deploying.
    - (1) For lighted buoys and large unlighted buoys: Shift the cageline to a point forward of the working buoy port. (It may be necessary to ease the crossdeck to facilitate shifting the cageline.)
    - (2) After the cageline has been shifted, slew the crane/boom outboard, controlling the swing with the crossdeck line, and lower the buoy hull until it is at the desired height for deploying.
  - h. Maneuver the buoy until it is positioned aft of the buoy port and remove the crossdeck.
  - i. Remove the mouse from the hook, check the chain stopper and pelican hook pins for freedom of movement
  - j. When the deck is ready to deploy the buoy, the phrase “READY ON DECK” is passed to the bridge. The bridge’s reply is, “STAND BY.”
  - k. The buoy deck supervisor (BDS) directs the appropriate rigger to remove the chain stopper pin. Once the pin is removed that rigger will standby to strike the chain stopper striking plate.
  - l. The bridge will pass, “SET THE BUOY.” The BDS will order the rigger manning the chain stopper to “TRIP IT.” The rigger will then trip the stopper.
  - m. Lower the buoy into the water and remove the hook from the buoy.
  - n. Once the hook is cleared from the buoy, trip the pelican hook allowing the remaining mooring chain to pay out over the side.
  - o. For lighted buoys, release and recover the cageline.
  - p. Rig the safety chain.
-



This page intentionally left blank



## Section C. Special Evolutions

---

**Introduction** Occasionally, Inland Buoy Tenders may be required to deviate from the procedures outlined in the standard buoy evolution described above. These occasions include but are not limited to handling a fouled mooring, working a buoy without lifting bails, searching for and recovering a sunken buoy, and retrieving a beached buoy. Prior to executing any buoy deck operation, all weight handling gear shall be inspected and exercised.

---

**C.1 Planning and Preparation** Since the following Special Evolutions deviate somewhat from the standard evolution, the Safety Supervisor and Buoy Deck Supervisor shall ensure that all deck crew members understand and can perform their roles in the evolution. Follow the procedures outlined in Appendix I of this manual when conducting required briefs prior to commencing these evolutions.

---

**C.2 Fouled Mooring Chain** Twisted (sometimes referred to as kinked) mooring chain often occurs in areas of rotary current or when the buoy swivel is not operating properly. Over time a twist will develop into a knot. A knot in mooring chain generally develops in three different ways: (1) from twisted chain, (2) when the bottom chain wraps around the sinker, (3) when mooring chain becomes fouled with a foreign object.

---

**CAUTION!** **Be aware that a mooring may be fouled with a sunken buoy or other object that could exceed the lift capacity of your weight handling gear.**

---

**C.2.a** A variety of tools and equipment are employed when recovering a fouled mooring including: oxy-acetylene torch, various slings, pelican hooks, Modeer shackles, etc.

---

**C.2.b** Bringing fouled or knotted mooring chain aboard a vessel increases the risk level of the evolution. Successful recovery of a fouled mooring requires safe rigging practices, patience, ingenuity, and close coordination between the conning officer and buoy deck. While no set of procedures can cover every situation that will arise when handling fouled moorings, the following general safety procedures will mitigate the risks.

---

**C.2.b.1** Stabilize the situation! As soon as a fouled mooring is discovered set the

---



---

chain into the chain stopper and set the pelican hook.

---

**C.2.b.2** Develop and discuss a recovery plan with the conning officer. Reassess risk and conduct an updated safety brief per Appendix A prior to commencing the recovery operation.

---

**C.2.c** The primary goal of the recovery plan is to safely bring the knot or fouled section of chain aboard the vessel. Having a knot unravel during the recovery effort could shock load weight handling gear causing serious damage. Therefore hoisting a mooring aboard the vessel from above the knot or fouled section is NOT considered an acceptable recovery method. Instead, the first objective of the recovery is to remove the strain from the knot or fouled section of the chain, in a sense; isolating the knot. The following are some general procedures for handling a knot or fouled mooring:

---

- (1) Ideally, the best way to isolate the knot is to hook a hoisting purchase into the moor below the knot, usually via a sling. Once the purchase is rigged in this way, the knot can be brought aboard and the chain below the knot secured in the chain stopper or pelican hook. At this point the knot can be removed from the moor by separating (cutting) it from the rest of the mooring.
  - (2) It may not be possible to hook a hoisting purchase into the chain below the knot. In those cases the best alternative may be to have the vessel drag the mooring away from Assigned Position (AP) and release it in safe water.
  - (3) Another less desirable alternative is to “choke” the knot with a sling, hook the purchase into that sling and bring the knot aboard. This method involves more risk as the knot may suddenly unravel, which could shock load weight handling gear causing serious damage.
- 

**C.2.d** After the knot or fouled section or mooring has been cleared, standard evolution procedures are followed.

---

**C.3 Damaged or Missing Lifting Bails** Recovering buoys with damaged or missing lifting bails. Recovering unlighted nuns and cans whose lifting bails have been damaged or carried away is accomplished using a lasso. A lasso is rigged using a rated eye-and-eye or endless wire rope or synthetic sling. The following are some general procedures for recovering buoys with damaged or missing lifting bails.

---



- 
- C.3.a** The lasso is slung around the buoy hull; boat hooks are used to work the Lasso into place. One end of the sling should be placed on the hoisting purchase or otherwise secured on deck.
- 
- C.3.b** Once the lasso is around the buoy hull and attached to the hoisting purchase, the hoist is lowered so that the lasso will work its way below the buoy hull and cinch up on the mooring.
- 
- C.3.c** The lasso will take hold of the mooring just below the buoy and as it is raised will pick up the buoy upside down. The buoy is then brought on board. Because the buoy is upside down, control on deck is very limited. Typically a crossdeck is attached to the buoy mooring bail to help control the buoy and guide it into the buoy saddle.
- 
- C.3.d** The mooring chain is hogged into the stopper, the pelican hook is set, the buoy is gripped, and the mooring is disconnected.
- 

**CAUTION!**

**The lasso should not be used as a choker around the buoy body due to the potential for slipping. Ensure that the lasso cinches around the mooring chain.**

**C.4 Dragging for and Recovering Sunken Buoys.**

All buoy tenders are called upon from time to time to drag for and recover sunken buoys. In the past, this was a slow, tedious and oftentimes ineffective process. With the incorporation of the Differential Global Position System (DGPS) into the buoy positioning process coupled with electronic charting the probability of successfully locating sunken buoys has significantly increased. The overall evolution of locating and recovering sunken buoys is typically broken down into three separate phases; (1) Dragging operations, (2) Snagging a submerged object, – ideally the sunken buoy – recovering the grapnel hook, and determining what has been snagged, and (3) Recovering the buoy and sinker.

---

**CAUTION!**

The largest buoy that a 100 foot WLI can safely recover is a 7x20 LIB, while the 65 foot WLI is limited to a 5X11LR or 2CR/NR. However, the sunken weight of a 6X20LBR far exceeds the Working Load Limit (WLL) of the 100' WLI weight handling system and the sunken weight of a 5X11LR and 2CR/NR far exceeds the WLL of the 65' weight handling system. Therefore, bringing recovered sunken buoy hulls aboard these vessels **SHALL NOT** be attempted until the water has been drained out of the buoy hull. If questions exist, consult tables 2-7 and 2-8 in the Aids to Navigation Technical Manual (COMDTINST M16500.3 (series)) for specific flooded buoy weights.

**C.4.a. Dragging Operations**

The grapnel hook – sometimes referred to as an anchor hawk – is an integral piece of gear used in the recovery of sunken buoys. Before deploying the grapnel hook however, the deck must be made ready to receive the sunken buoy and mooring. These preparations include but are not limited to: staging crossdeck(s), steadying lines, oxygen/acetylene torch, and other appropriate tools and equipment.

**NOTE** 

Employing a 36" oxygen/acetylene torch will enable personnel to decrease the buoy's sunken weight by cutting a drain hole in the buoy hull before its entire weight is bore by the vessel's weight handling gear. Although outfitted with less reach than the above torch, an Exothermic cutting torch is typically faster and is effective with the cutting rod underwater.

**C.4.b Deploying the Grapnel**

- (1) Attach a section of buoy chain (allowing for a scope of 1.5:1 to 3:1) to a grapnel hook, which weighs approximately 100 pounds.
- (2) Fake the remaining chain athwartships in the buoy port.
- (3) Secure a bight of chain (approximately 10 feet from the bitter end) in a pelican hook, which is located in the aft buoy port. Stop the bights of chain between the pelican hook and chain stopper to the bull chain with rotten stop as necessary.
- (4) Request "PERMISSION TO HANG THE GRAPNEL" from the bridge. The bridge will reply, "HANG THE GRAPNEL."
- (5) Once the grapnel is hung, request "PERMISSION TO TRIP THE GRAPNEL" from the bridge. The bridge will reply, "TRIP THE GRAPNEL."

**NOTE** 

**The conning officer should keep slight way on when the grapnel hook is deployed to avoid having the chain pile atop the grapnel hook.**

**CAUTION!**

**Take due care to ensure that the grapnel hook is not dragged over a submerged cable or restricted area.**

**C.4.c Conning Tips**

The following conning tips may facilitate the safe and successful recovery of a sunken buoy and its mooring:

- (1) The search area parameters can be marked either electronically via the Electronic Chart System (ECS), by outlining the area with marker buoys, or by employing both methods.
- (2) In areas with a predominate current, the buoy and its mooring will typically lay parallel to the current either up or down stream from the buoy's assigned position. Dragging across this line produces the strongest possibility of successfully snagging the sunken buoy or its mooring chain.
- (3) As with every evolution involving ship handling, the current should be used to best advantage. Stemming the current and crabbing 10 to 15 degrees to each side across the current while moving upstream at the end of each pass will increase the probability of success.
- (4) One of the more common mistakes committed when dragging for a sunken buoy is excessive speed of advance, i.e. towing the grapnel hook too fast, which causes it to bounce along the bottom. The chances of recovering a sunken buoy or its mooring are significantly reduced when the grapnel hook is not in contact with the bottom.
- (5) The conning officer must be acutely aware of the cutter's proximity to shoal water, obstructions, and other hazards.

**C.4.d. Snagging a Submerged Object**

When a grapnel hook fetches up on an underwater object – hopefully the sunken buoy or its mooring – there remains a degree of uncertainty as to what has been actually snagged. For example, while dragging for a 3CR with a single mooring, you may have actually hooked into a 2CR with a double mooring. Therefore, safe and successful recovery of a sunken buoy requires sound rigging practices, patience, ingenuity, and close coordination between the conning officer and buoy deck. Before recovering the grapnel hook and its catch, the 1" chain attached to the grapnel hook must be transferred from the pelican hook to the chain stopper. The following is the standard evolution to affect this transfer.





- (1) Attach a safety shackle into the 1” chain approximately 8 to links from the pelican hook towards the bitter end, attach a tagline to the end of the 1” chain, and rig a hogging line leading forward and a crossdeck leading forward and inboard from the pelican hook.
- (2) Request “PERMISSION TO SET THE CHAIN IN THE STOPPER” from the bridge. The bridge will respond “SET THE CHAIN IN THE STOPPER.
- (3) Once permission is granted, spot the crane/boom slightly inboard of the pelican hook and hook the appropriate purchase into the safety shackle. Attach the hogging line into the 1” chain outboard of the pelican hook and the crossdeck between the hoisting purchase and the pelican hook.
- (4) Ensure that the tagline is tended and take a slight strain on the hoisting purchase, hogging line, and crossdeck, and trip the pelican hook.

**CAUTION!**

**Exercise care when lifting the chain out of the pelican hook to prevent shock loading.**

- (5) Using the hoisting purchase, hogging line and crossdeck, maneuver the chain into the chain stopper.

**NOTE**

**The conning officer should keep a slight forward lead on the chain to facilitate placing it into the stopper.**

- (6) After the chain is set in the chain stopper, refer to the standard evolution for pulling chain – paragraph A.5 of this chapter – until the grapnel hook is at the water’s edge.

**C.4.e Grapnel in Sight**

With the grapnel at the water’s edge, a clearer assessment of the situation may be possible. In most cases the grapnel hook will have snagged the sunken buoy’s mooring chain and so a bight of chain will be draped in one or more of the hook’s prongs. Typically the sunken buoy is attached to one end of the chain bight and the sinker is attached to the other end. In this situation, the buoy and sinker must be recovered separately. Therefore, before either can be recovered, the mooring chain must be cut.

**C.4.f Recovering the Buoy and Sinker**

The overriding consideration for this phase of the evolution is to maintain control of both ends of the mooring chain. As with all buoy deck evolutions, employing sound rigging practices, exhibiting patience, and ingenuity and maintaining close coordination between the conning officer and buoy deck are paramount in ensuring a safe and successful evolution. While no set of procedures can cover all situations, the following standard



---

procedures are provided to mitigate the risks:

- (1) Attach a safety shackle into the 1” chain just inboard of the chain stopper jaws, lay out the crossdeck and hogging line, and remove the horse collar. Ensure that the bitter end of the 1” chain attached to grapnel hook is secured (see note below).
- 

**NOTE** 

**Two pelican hooks must be rigged; one in the after buoy port and one inboard of the bull chain – this second pelican hook is used to stop off the bitter end of the chain attached to the grapnel hook.**

---

- (2) Request “PERMISSION TO BRING THE GRAPNEL ABOARD” from the bridge. The bridge will respond “BRING THE GRAPNEL ABOARD.”
  - (3) Once permission is granted, spot the crane/boom slightly inboard of the chain stopper and hook the appropriate purchase into the safety shackle. Attach the crossdeck to the 1” chain inboard of the hoisting purchase.
  - (4) Drop the safety chain and then lift the chain out of the chain stopper. Once the chain is clear of the stopper, maneuver the crane/boom so that the grapnel hook is slid aft of the chain stopper but still at the forward part of the buoy port. Slowly hoist the grapnel hook until it is clear of buoy deck sill.
  - (5) Heave around on the crossdeck as the boom/crane is slewed inboard.
  - (6) When the grapnel hook is over the bull chain or when there is enough slack in the mooring chain, attach the hogging line to the most forward leg mooring chain, and hog it into the chain stopper.
- 

**WARNING** 

**Both legs of the mooring chain are considered LIVE CHAIN – Allow no one to step on or move outboard of this chain. Handle chain with chain hooks, NOT HANDS!**

---

- (7) Once the forward leg of the mooring chain is secured in the chain stopper, rig the hogging line with an aft lead.
  - (8) Attach the hogging line into the leg of the mooring chain that’s aft of the grapnel hook and not already secured in the chain stopper. Maneuver this leg of the mooring chain into the aft pelican hook using the hoisting purchase and hogging line.
  - (9) When both legs of the mooring chain are secured, clear the grapnel hook if possible. (If it isn’t possible to safely clear the grapnel hook at
-



this point, then set it on deck keeping a strain on the hoisting purchase.)

- (10) Cut the mooring chain and clear the grapnel hook (if it has not already been cleared). Rig the safety chain and prepare to bring the forward leg of the mooring (the leg in the chain stopper) following standard procedures for pulling chain – paragraph A.5

**C.4.g. Recovery Determination**

If the forward leg of the mooring is attached to the sinker, then follow the standard procedures for bringing the sinker aboard – paragraph A.6 above.

If the forward leg of the mooring is attached to the buoy, then be prepared to bring the buoy on deck up-side-down. The following procedures are provided to help mitigate the risks:

- (1) Rig the cross-deck to facilitate bring a buoy aboard, i.e. to maintain horizontal control of the buoy in the buoy port. Set saddle and head blocks as necessary. Because the buoy will be brought aboard up-side-down and backwards, the head block will be deployed opposite of its normal position.

**NOTE** 

**Because the buoy will be brought aboard up-side-down and backwards, the head block is deployed between the buoy saddle and the working buoy port – opposite of its normal position.**

- (2) Request “PERMISSION TO BRING THE BUOY ABOARD” from the bridge. The bridge will respond “BRING THE BUOY ABOARD.”
- (3) Once permission is granted, spot the crane/boom slightly inboard of the chain stopper, hook the appropriate purchase into the safety shackle, and attach the cross-deck into the mooring chain inboard of the hoisting purchase.
- (4) Hoist the buoy until the buoy body clears the buoy deck sill, slew inboard, and heave around on the crossdeck.

**WARNING** 

**The sunken weight of most buoys far exceeds the WLL of WLI hoisting gear. Therefore, allow the water to drain from the buoy prior to bringing it aboard. In some cases a hole will have to be cut in the buoy hull to facilitate the water draining from the buoy.**

- (5) Use a combination of the cross-deck line and the crane/boom to slowly maneuver the buoy across the deck – **keeping it low to the deck** – until it is in position to be lowered into the saddle or onto appropriate



---

dunnage.

- (6) Once the buoy is in the saddle or set on appropriate dunnage, follow the standard procedures for bringing the buoy aboard as describe in paragraph A.5.
- 

**NOTE** 

**After the forward leg of the mooring has been successfully recovered, transfer the aft leg, i.e. the leg of the mooring secured in the pelican hook, following the procedures outlined in paragraph A.5.**

---

**C.5 Buoys  
Washed Ashore**

An Inland Buoy Tender may be called upon to recover a buoy that has washed ashore.

---

**C.5.a Shore  
Party**

Typically a shore party is debarked to assess the buoy's condition. The shore party's primary missions are to ensure:

- (1) The buoy's structure is sound and that it will not sink during towing operations.
  - (2) The buoy is disconnected from its mooring and free from any obstructions that would hinder the towing operation.
  - (3) The towline is properly rigged. The towline **shall** be of sufficient size and strength for the weight of the buoy, accounting for its grounded weight as well, and is securely attached to one of the buoy's lifting bails.
- 

**NOTE** 

**The vessel's towing bill and appropriate safety procedures shall be followed during towing operations.**

---

**C.5.b Cutter  
Role**

When the buoy is towed into an area where it is deemed safe by the CO/OIC of the WLI for the vessel to recover the buoy, then the buoy is retrieved using the procedures outlined in paragraph B.4 of this chapter. The vessel's towing bill and appropriate safety procedures **shall** be followed during towing operations.

---

**CAUTION!**

**When transitioning from the towing bill to the ATON bill, the towline shall be constantly tended by competent personnel to ensure that the towline does NOT become fouled with the vessel.**

---



This page intentionally left blank

# Chapter 11

## River Buoy Tender Operations

---

### Introduction

This chapter presents an overview of aids to navigation (ATON) operations aboard the 65 and 75 foot class River Buoy Tenders (WLR). Knowledge of the river and the types of vessels navigating the river are very important to the understanding and ability to correctly mark the channels. Safety rules, standard evolution procedures, and sound seamanship practices shall be followed whenever engaged in any ATON or weight handling evolution.

On pooled waters, the gauge above and below a section to be buoyed must be known, (i.e., the present reading, the low water reading, and the project depth for the section). On open rivers, it is important to remain apprised of the river stages, forecasts, and weather forecasts to anticipate changing river stages. This chapter is not intended to cover all operational situations these vessels might encounter in the course of executing Coast Guard missions.

The channel width will be maintained at the maximum width consistent with Corps of Engineers' project depth and prevailing conditions. However, in periods of low water, it is not always possible to maintain the published project depth or width. As a result, the channel must be narrowed. If project depth or width cannot be maintained at the Corps of Engineers' published minimum, a Broadcast Notice to Mariners must be issued.

Perhaps more than in any other type of ATON work, intimate piloting knowledge of the local area must be thoroughly learned. Experience and local knowledge play a vital part in a well-maintained channel.

---

### In this chapter

This chapter contains the following sections:

Section	Topic	See Page
A	General Information	11-3
B	Standard Buoy Evolution	11-9
C	Special Evolutions	11-21
D	ATON Work Ashore	11-23
E	Cutter Boat Operations	11-27

---



This page intentionally left blank



## Section A. General Information

### Introduction

River Buoy Tenders are equipped to work on either pooled waters or open flowing rivers. The techniques are similar; however, the thought process is different when it comes to placing buoys to best mark the channel.

### A.1. Buoy Handling Equipment

There are two classes of WLR, the 75ft WLR and the 65ft WLR. These cutters push barges of 90ft, 99ft, and 130ft lengths. Each barge has a hydraulic knuckle boom crane that is used to load and pre-position ATON buoys and sinkers on deck. ATON buoys and sinkers are deployed using dump boards. A pneumatic or hydraulic capstan is located amidships at the buoy port which is used to pull the buoy on board and raise the sinker.

### A.1.a Allied Marine Crane Description

The following information applies to cutters equipped with an Allied Marine Crane (Model TK 20-50). This crane can be rigged with a single-part or two-part configuration. Detailed specifications and information can be found in CG Tech Pub 3364 in the Naval Engineering Technical Information Management System (NE-TIMS).

### A.1.b Allied Marine Crane Characteristics

Maximum Swing Range	360 Degrees
Boom Angle (min/max)	0 – 85 Degrees (for main boom part)
Jib Boom	157 Degrees arc of operation
Boom Length	Fixed – 60 ft
Boom Reach (min in reach)	5' 7" with main boom at 0 degrees
Boom Reach (max outreach)	Telescoping from 40 ft – 50ft with jib boom extended
Maximum WLL	2,000 lbs @ 50 ft radius, 20,000 lbs @ 10 ft radius (with two-part rigged)
Wire Rope	250 ft of ¾" 8x19 RRL EIPS IWRC – Breaking strength 51,800 lbs
Maintain a minimum of 5 wraps of wire rope on drums at all times	

### A.1.c Appleton Crane Description

The following information applies to cutters equipped with an Appleton Marine Crane (Model KB20-10-50). This crane can be rigged with a single-part or two-part configuration. Detailed specifications and information can be found in CG Tech Pub 3363.





**A.1.d. Appleton Crane Characteristics**

Maximum Swing Range	360 Degrees
Boom Angle (min/max)	0 – 80 Degrees (for main boom part)
Jib Boom	157 Deg arc of operation
Boom Length	Fixed – 60'
Boom Reach (min in reach)	10ft with main boom at 0 degrees 8ft with main boom at 80 degrees
Boom Reach (max outreach)	50ft with jib boom extended
Maximum WLL	3,000 lbs @ 50ft radius, 20,000 lbs @ 10ft radius (with two-part rigged)
Wire Rope	250ft of 3/4" 6x37 RRL XIPS IWRC
Maintain a minimum of 5 wraps of wire rope on drums at all times	

**A.1.e Warping Capstans**

Barges are equipped with both hydraulic or air capstans used for sinker and stock pile retrieval. Specific characteristics and locations of the capstans are too varied to list in this manual; users should refer to applicable technical manuals for their individual cutter or barge.

**A.2 Pooled Water**

On the pooled rivers, generally the Ohio, Tennessee, Cumberland, Illinois, Arkansas, and Upper Mississippi (above St. Louis) River levels are controlled by the Army Corps of Engineers. The water levels are relatively stable and buoys seldom move. The buoys are set using sinkers with wire rope or chain moorings.

**A.3 Fast Water**

On the Mississippi River below St. Louis and the Missouri River, due to the wide range of water levels and changing conditions, the position of both buoys and dayboards may change. Crossing dayboards are used to mark the channel as it moves from one bank to the other and buoys are set using sinkers with wire rope. On the Missouri River in areas with a soft bottom, buoys are set using a "jet pipe." A jet pipe is a device that uses water pressure to force a cone connected to a wire rope mooring into the bottom to hold the buoy on station. In areas with a rock bottom, the buoys are set using sinkers.

**A.4 Buoys and Equipment**

ATON hardware used in the Eighth District by the River Buoy Tenders is different from the equipment used elsewhere in the service.

**A.4.a Buoys**

Buoys are metal or plastic, foam filled, radar reflecting, with a fin to stabilize them in a swift current. A few lighted buoys are set in pooled areas.

**A.4.a.1 6th Class Buoys**

Most 6th class river buoys (See **Figure 11-2**) are attached to 1,000 to 1,500 pound sinkers or jet cones using 1/2" or 3/8" wire rope and wire rope clips. When sinkers are used, the wire rope is coiled on top of the sinker or set over the side by dropping the coil or streaming the wire before setting the



---

buoy to prevent fouling during the buoy deployment.

---

#### A.4.a.2 4th Class Buoys

Use of 4th class buoys (See **Figure 11-1**) is common where 6th class buoys (See **Figure 11-2**) do not have enough buoyancy to provide a good visual signal for the mariner. Usually, 4th class buoys are deployed with 1/2" chain or 1/2" wire rope moorings and a 1,500-pound sinker.

---

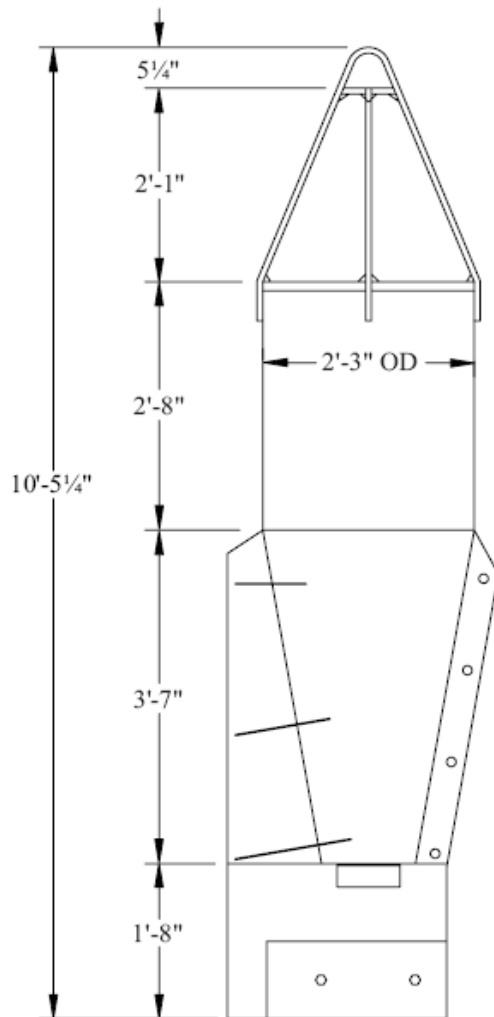

**11-1**  
**4th Class Buoy (4NR)**

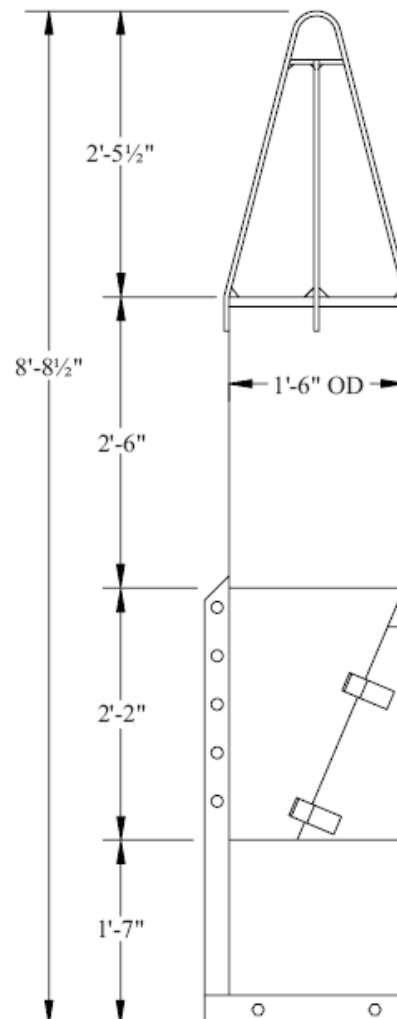

**11-2**  
**6th Class Buoy (6NR)**

#### A.4.b Sinker

Sinker weights vary with 1,000 and 1,500 pounds being the most common. There are two bails on the sinkers. One bail is on the top of the sinker and is used as a lifting eye. The second bail is on the side of the sinker and is used for the attachment (See **Figure 11-3**) of the wire rope or chain. The

---



side-mounted attachment offers the least amount of sinker profile during retrieval. The wire rope used to secure the buoy is also used to retrieve the sinker.

Sinkers are normally set in one of two ways. Either two pry bars are placed under the sinker and used to slide it overboard, or the sinker is placed on a dump board (See **Figure 11-4**). The dump board allows a single person to deploy a sinker because of the lever action and pivot pin.

---



**11-3**  
**Western River Sinker**



**11-4**  
**Dump board**

**A.4.c Wire Rope Moorings** ½” wire rope moorings are primarily used in fast water. Mooring lengths are usually 45ft, also known as a river shot, and up to 90ft in length. The wire will be attached to the sinker with an overhand knot with the bitter end reeved twice around the wire to form an eye and secured to the standing part with a single wire rope clip. The wire rope clip needs to be positioned 8-10” below the knot to leave enough space to insert the cross deck hook. Shackles may be used when mooring wires are pre-fabricated.

---

**A.4.d Chain Moorings** Primarily used in pool water and in some shallow water applications. Length of mooring is determined by the water stage or depth. Two shackles are used to attach the mooring to the sinker and buoy. A top swivel (optional) may be attached between the buoy and mooring based on location, water depth, local area knowledge, and at the discretion of the Officer in Charge (OIC).

---

**A.4.e Jet Cone Moorings** Primarily used in water depth of 20ft or less. The jet cone is attached to the end of the jet pipe with a wire rope mooring attached through the eyes of the jet cone with one wire rope clip. The wire is fairlead through the finger cleat to keep a strain on the cone making sure it stays secured to the end of the jet pipe. The pipe is lowered to the bottom and water is pumped through as the pipe is lowered into the mud or sand. Once the jet pipe has achieved maximum penetration, or reaches refusal, the water is secured, the pipe raised and the remaining cone and mooring is tested for fixity. Once

---



---

the security of the mooring is determined, the buoy is attached and set.

---

**A.5 Deck  
Equipment**

This section details various pieces of equipment that is used throughout the ATON evolutions in the River Tender world of work.

---

**A.5.a  
Emergency  
Situations**

An axe and wire cutter shall always be readily available to cut wire rope in an emergency situation. If the wire is under tension, the axe shall be used. If there is no tension and the circumstances permit, the wire rope cutter may be used.

---

**A.5.b  
Lasso/Reeving  
Hook**

A 1/2" wire rope lasso is used to "lasso" the buoy. Another method is to use a 1/2" wire rope with a hook attached that is used to hook the lifting bail of the buoy. The reeving wire/hook is attached to a reeving tool allowing the rigger to reach out and hook the buoy. With either method, this wire is referred to as the cross-deck. The wire is then taken to the capstan and the buoy is hauled aboard.

---

**A.5.c Preventer**

Chain made up of 1/2" alloy chain with a hook attached to a padeye located near the capstan shall be used to secure the buoy to the deck to prevent it from being moved around on deck by the mooring. This length of chain is referred to as a "preventer."

---

**A.5.d Chain  
Stopper**

Some WLRs have chain stoppers to handle the chain moorings that may be within their or another cutter's area of responsibility.

---



This page intentionally left blank



## Section B. Standard Buoy Evolution

---

**Introduction** This section covers buoy evolutions used on the Western Rivers in the various operating environments that are found in District Eight.

---

**B.1 Planning and Preparation** Bridge and buoy deck crews shall convene a briefing session before beginning work, following the procedures outlined in Appendix 1 of this manual. After the briefing session is conducted in accordance with Appendix 1, complete the following:

- a. Where applicable, energize the appropriate deck equipment. Exercise all buoy handling equipment including the crane, capstan, and mechanical stoppers. Verify that any gripes and bull chains used are inspected and exercised to ensure proper operation. Permission should be requested from the bridge prior to exercising the crane.
  - b. Rig applicable deck gear and tools.
  - c. The crane, when not being used as a part of the evolution should be centered with the boom facing aft. If the crane is used as part of the evolution, it should be positioned in such a way as to not interfere with the evolution or the safe navigation of the cutter.
  - d. Remove the appropriate stanchions and lifelines located in the working buoy port. Ensure that the safety chain is rigged when appropriate.
  - e. When all is ready on the buoy deck, the Buoy Deck Supervisor (BDS) or Safety Supervisor notifies the bridge: **“READY ON DECK.”**
- 

**B.2. The Approach** Shiphandling, specific to working alongside buoys, is covered in Chapter 8 of this manual. The conning officer will inform the BDS or Safety Supervisor whether the buoy will be approached on the port or starboard side. This decision is typically dependant on environmental conditions, deck space availability, and typical cutter practices. On pooled rivers, the spuds are not normally used to work buoys. They are used as a mooring device when the cutter is pushed into the bank. On open rivers and in deep water, the tender will stem the current and work the aid. When using the jet pipe, tenders will spud down to provide a stable platform. Any movement of the cutter could bend or break the jet pipe.

---

**B.2.a Relief** The following are the standard evolutions for completing a buoy relief

---



---

**Procedures**

aboard a River Buoy Tender.

---

**B.2.b Wire or Chain Moorings**

Typically, unlighted river buoys are brought aboard without the use of the crane. The capstan alone is used to recover the buoy, mooring, and sinker.

- (1) Lay out and inspect all the equipment to be used and conduct a safety brief.
- (2) When the deck is set up and the crewmembers are ready, pass to the bridge, **“READY ON DECK”**
- (3) The bridge will give permission by passing: **“HOOK IT WHEN YOU CAN.”**

---

**NOTE** 

**A reeving device or hook with a safety latch or lasso is the method used in retrieving a river buoy.**

---

**NOTE** 

**A minimum of 3 turns shall remain on the capstan at all times while bringing the buoy aboard. This is to maintain positive control and eliminate any uncontrolled slipping of the mooring.**

---

- (4) Once the buoy is aboard, a preventer chain, with a hook attached to a pad eye at the base of the capstan, is hooked to the buoy for positive control and to eliminate the possibility of the buoy unexpectedly going over the side.
- (5) After the buoy has been attached to the preventer chain, a cross deck is hooked into the mooring, secured to the lower half of the capstan in the opposite direction and a strain is taken on the mooring. The lasso is cleared from the capstan. The mooring can then be unshackled from the buoy. Once the buoy is cleared, the mooring can be hauled aboard.

---

**NOTE** 

**If working with chain and a pelican hook is used the command “TRIP THE PELICAN” will be given prior to pulling the chain.**

---

**CAUTION!**

If there is no floating debris in the river, hand tending the slack wearing gloves may be an option with the authorization of the OIC. This option is based on the river condition and the level of expertise of the deck crew and OIC. This method requires expert shiphandling, sound judgment, and positive communication between the bridge and the buoy deck. Keep in mind, the safety of the crew is **ALWAYS** the primary concern and should be considered if you choose to use this method. If this method is chosen, a minimum of 3 turns shall remain on the capstan and 2 crewmembers will participate, one tending the wire on the capstan and the other pulling the slack from the buoy

**NOTE** 

Depending on the position of the sinker when it comes up on deck, it may be necessary to use the crane to reposition it to be reset or to clear the buoy deck for the next evolution.

**CAUTION!**

When repositioning the sinker by hand or with the crane, ensure that the mooring is still on the capstan to maintain positive control of the mooring while repositioning and to eliminate the possibility of the sinker going over the side unintentionally.

- (6) Once all gear is recovered and secured properly on deck, pass to the bridge, "**ALL CLEAR**" and rig the safety chain as appropriate.

**B.2.c Chain Moorings**

The below procedures are to be utilized when working with lighted buoys that have a chain mooring:

- (1) Lay out and inspect all the equipment to be used and conduct a safety brief.
- (2) When the deck is set up and the crewmembers are ready pass to the bridge, "**READY ON DECK**"
- (3) The bridge will give permission by passing: "**HOOK IT WHEN YOU CAN.**"

**NOTE** 

When recovering lighted buoys a boat pole may be used to bring the buoy into the buoy port. The lifting hook or sling may be directly passed to the lifting bale or a reeving device may be utilized to pass a hook or lifting sling through the bale for lifting.





- 
- (4) Once the buoy is hooked, lift it just high enough so the chain falls into the chain stopper.
- 

**NOTE** 

**If the barge deck is not equipped with a chain stopper and chain moorings are utilized, the capstan will be used to recover the mooring following the same steps as a wire rope mooring.**

---

- (5) Once the chain is securely in the chain stopper the buoy is set on the deck and the mooring is disconnected. The buoy may be left on deck by the stopper or moved out of the way.
- 

**WARNING** 

**When relocating buoys with the crane, always keep the load as low to the deck as possible. Buoys should never be left suspended while pulling the chain into the chain stopper with chain hooks.**

---

**WARNING** 

**The entire length of the mooring attached to the sinker is considered LIVE – ALLOW NO ONE TO STEP ON OR GET OUTBOARD OF MOORING.**

---

- (6) Use either the capstan (if no chain stopper is available) or the crane to stage lift in conjunction with using the stopper to pull the chain.
- 

**NOTE** 

**A horse collar is required when using the main to perform a stage lift. After each pick is taken, the chain is pulled into the chain stopper either using chain hooks or a line with a grab hook attached to get the chain properly seated into the chain stopper.**

---

**CAUTION!**

**In some cases, the crane alone may not be able to break a sinker free from the bottom. In those cases, secure the chain mooring in the chain stopper and set the pelican hook. Maneuver the vessel around the mooring until the sinker is broke free from the bottom. Once the sinker is free, commence pulling chain as before using the crane.**

---

- (7) Once the sinker and all gear is recovered and secured properly on deck pass to the bridge, “**ALL CLEAR**” and rig the safety chain.
-



---

<b>B.3 Inspection of Buoy Hull, Mooring and Appendages</b>	After recovering a buoy, mooring, and sinker, an inspection shall be completed to determine the overall condition and usability of each piece of ATON equipment. Complete the inspection and any repairs using guidance contained in the Aids to Navigation Manual – Technical, COMDTINST M16500.3 (series).
--	--

---

<b>B.3.a Holed or Damaged Buoy</b>	If the buoy feels heavy or there is reason to believe that there is water in the buoy hull, hook the crane to the lifting bale and verify the weight in accordance with the weights listed in the ATON Technical Manual. A holed or damaged buoy may be heavier and must be removed from service if it cannot be drained and repaired.
------------------------------------	--

---

<b>B.3.b Scrap Buoys</b>	Buoys found to be serviceable shall be placed back into service. Those that do not pass the inspection will have the letter “S” or the word “Scrap” painted in a visible location and placed in the scrap pen for proper recycling at the cutter’s homeport.
--------------------------	--

---

<b>B.3.c Unusable Moorings</b>	Moorings that are found to be unusable according to the Aids to Navigations Manual – Technical (COMDTINST M16500.3 (series)) will be taken out of service and recycled upon return to the cutter’s homeport.
--------------------------------	--

---

<b>B.3.d Unusable Sinkers</b>	Sinkers that are found to be unusable in accordance with the Aids to Navigations Manual – Technical (COMDTINST M16500.3 (series)) will be taken out of service and properly disposed of upon return to the cutter’s homeport.
-------------------------------	---

---

<b>B.4 Setting the Buoy with a Jet Pipe</b>	<p>When setting buoys using a jet pipe, the position of the buoy is determined and the spud is set. The jet cone is attached to the wire rope and then over the end of the jet pipe and lowered to the bottom. The jet pump is then engaged and the water pressure forces the jet cone into the soft bottom and buries it. The wire rope mooring is then cleared from any obstructions on deck and the buoy is pushed overboard.</p> <p>a. When near the position where the buoy will be set, the bridge gives the command to <b>“STAND BY TO JET A CAN/NUN BUOY.”</b> Upon this command, deck personnel will place the buoy in the buoy port and take their positions. These positions include one BDS, one person tending the buoy/wire mooring, one person tending the jet pipe, one person operating the spud controls, and a crane operator. The buoy is rigged by attaching one end of the wire mooring to the buoy with a shackle. The other end has a jet cone attached and is fairlead around the starboard or port bow and then is rigged in a fairlead device (See <b>Figure 11-5</b> and <b>11-6</b>). This is the standby</p>
---	--

---



---

position. The “cone” end is at the center of the barge bow and is not yet attached to the jet pipe. The remaining wire mooring (middle section) stays coiled on deck until Step “e”.

- b. After the Conning Officer has maneuvered the vessel to the desired buoy position, the command, “**LOWER THE BARGE SPUD,**” is given. The BDS echoes this command and the spud is lowered.
- 



**Figure 11-5**  
**Wire Rope Fairlead Device**

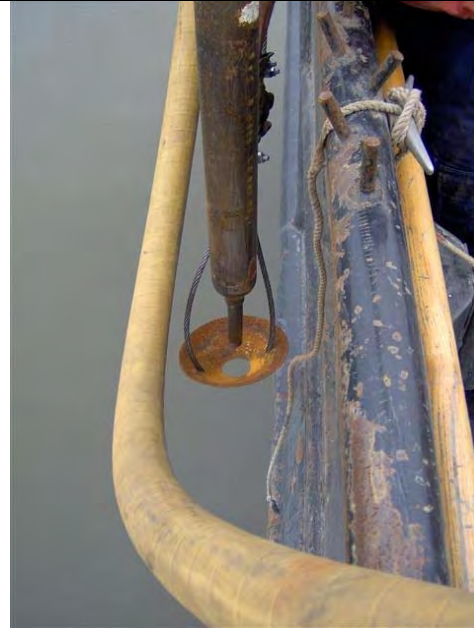

**Figure 11-6**  
**Jet Pipe Over the Side**

---

- c. Once the spud is lowered and holding the vessel in position, the BDS will inform the Conning Officer that the spud is set. The Conning Officer will then give the command, “**JET THE BUOY.**”
- d. The BDS will echo the command “**JET THE BUOY.**” Upon this command the crewmember tending the jet pipe at the center of the bow will attach the jet cone to the end of the jet pipe, insure the wire is placed in the fairlead device, and then engage the water pump. At this point the crewmember will notify the BDS that the jet pipe is “**RIGGED AND READY.** (See **Figure 11-6**)
- e. The BDS will now give the command to the crewmember tending the wire and buoy to “**STREAM THE WIRE.**” The crewmember will push or throw the middle section of the coiled wire mooring over the side. The crewmember will then inform the BDS that the “**WIRE IS STREAMED.**”
- f. The BDS will now sound off to the deck crew “**COMING DOWN.**” The BDS will give the proper hand signals to the crane operator to lower the jet pipe to the desired set depth of 10 ft or more.
-

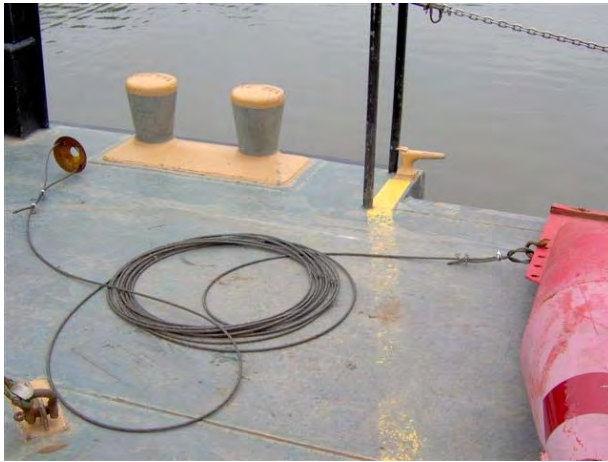

**Figure 11-7**  
**Jet Cone Mooring on Deck**



**Figure 11-8**  
**Jet Cone**

**NOTE** 

**To achieve a desired set depth you must know the water depth at the location of the jetting. For example, with a water depth of 10 ft, the 30 ft jet pipe would be lowered 20 ft to achieve placement of the jet cone at least 10 ft into the riverbed.**

- g. Once the jet pipe is lowered to the desired depth, the BDS will give the command, "**PREPARE TO RAISE THE JET PIPE.**" Upon this command the crewmember tending the jet pipe at the bow will remove the wire from the fairlead device and drop the remaining wire into the water. The crewmember will then disengage the water pump. The crewmember will inform the BDS the jet pipe is ready to be raised.
- h. The BDS will now sound off to the deck crew "**COMING UP.**" The BDS will give the crane operator the proper hand signals to raise the jet pipe.
- i. When the jet pipe is raised, the BDS will inform the Conning Officer, "**READY ON DECK.**"
- j. The Conning Officer will give the command "**RAISE THE BARGE SPUD.**" This command is echoed by the BDS and the spud is raised.
- k. When the spud is raised, the Conning Officer gives the command "**SET THE BUOY.**" The BDS echoes this command and the buoy is set. The BDS will inform the Conning Officer "**ALL CLEAR.**" The vessel is then maneuvered at a safe speed away from the buoy.



## B.5 Recovering Jet Pipe Moorings

---

The following steps will guide a WLR's crew in the recovery of a jettied buoy:

- a. The Conning Officer will inform the deck personnel to **"PICK A CAN/NUN BUOY."** Upon this command, the deck personnel will take their position on deck. These positions include one BDS, one crewmember operating the capstan controls, one crewmember tending the wire rope on the capstan, and two crewmembers at the buoy port to assist in retrieving the buoy by using a lasso or cross deck device.
  - b. The Conning Officer will maneuver the vessel at a safe speed in such a way to bring the buoy close enough to the buoy port so that crewmembers can place a wire lasso or connect a wire cross deck to the buoy. During the process of recovering the buoy, it is important that the BDS keep constant communications with the Conning Officer. The BDS must constantly inform the Conning Officer of the buoy's position relative to the buoy port.
  - c. When the buoy is near the buoy port and the BDS sees that it is safe to lasso or connect a cross deck to the buoy, the BDS will give the command to **"HOOK/LASSO THE BUOY."** Upon this command, a crewmember applies the lasso or cross deck to the buoy. When hooked or lassoed, the crewmember will take the remaining wire to the capstan, placing a minimum of three turns on the capstan.
  - d. When permission to bring the buoy on deck is granted, the BDS will give the command to **"HEAVE AROUND"** in conjunction with the hand signal of heave around right or left. The capstan controller will then engage the capstan control and begin bringing the buoy onboard.
    - (1) Once the buoy is on deck, set the preventer chain to maintain positive control of the buoy. If there is enough slack in the wire mooring, the BDS will give the command to **"PULL THE SLACK AND TAKE IT TO THE CAPSTAN."** If this is the case, a crewmember will begin disconnecting the mooring from the buoy. Another crewmember will pull enough slack to take to the capstan. During this time, the capstan is cleared of the lasso or cross deck. Once the capstan is cleared, and the mooring is disconnected from the buoy, a minimum of three turns of the wire mooring is placed around the capstan.
    - (2) If there is no slack in the wire sufficient enough to take directly to the capstan, the BDS will give the command **"CONNECT THE CROSS DECK."** Once the mooring is unshackled from the buoy, the mooring can be hauled aboard keeping a minimum of three turns on the capstan.
-

NOTE 

**Either procedure should result in the disconnecting of the mooring from the buoy while maintaining positive control at all times.**

- e. Once the buoy is clear, the BDS will again give the command “**HEAVE AROUND.**” The capstan operator will engage the capstan controls and begin heaving around on the wire mooring. This will continue until the jet-cone breaks free from the riverbed.

NOTE 

**In most cases, jet-cone moorings cannot be recovered due to the strength of the jet-cone being placed 10ft into the riverbed. If this is the case, the wire mooring should be heaved around on until brought to short stay, slacked a little to prevent snap-back, and then cut.**

### **B.6 Setting a Buoy using Wire and a Sinker**

When setting buoys using wire rope and a sinker, the sinker is positioned at the deck edge or on the dump board with the standard mooring attached and the wire coiled clock wise and placed on the sinker. When in position, the sinker is set. Depending on the river condition, the wire may be streamed prior to setting the sinker. The buoy is then pushed overboard.

- a. When in the vicinity of the position where the buoy will be set, the Conning Officer gives the command to “**STAND BY**”. Upon receiving this command, deck personnel will place the buoy in the buoy port and take their positions. These positions include one BDS, two Riggers (if necessary) tending the buoy, and one Rigger tending the dump board.
- b. When all deck personnel have taken their positions and have ensured that the wire mooring is clear of all deck fittings, the BDS will inform the Conning Officer “**READY ON DECK**”.

WARNING 

**Cleats and/or chain stoppers may be located in the area between the dump boards and buoy port. It is important to ensure that the wire mooring connecting the sinker to the buoy is not fairlead on the inboard side of any of these fittings to prevent fouling upon setting the sinker and buoy.**

- c. As the position where the buoy is to be set approaches, the Conning Officer gives the command to “**STAND BY.**” The deck crew may “stream” the wire if preferred by pushing the coiled wire from the sinker into the water and the deck crew will pull the pin on the dump board. The BDS will inform the Conning Officer “**READY ON DECK (RED/GREEN)**”.



- 
- d. When the cutter has maneuvered into the position where the buoy is to be deployed, the Conning Officer will give the command, “**SET IT.**” The deck crew trips the dump board, jettisoning the sinker overboard, and pushes the buoy over the side. (See **Figures 11-9** and **11-10**)
  - e. Once the buoy has been deployed and the BDS has confirmed that the buoy, mooring, and sinker is clear of the deck, the BDS will inform the Conning Officer “**BUOY AWAY, ALL CLEAR.**”
  - f. The vessel is then maneuvered at a safe speed away from the buoy.
- 

**11-9****Deploying Sinker with Dump Board****11-10****Pushing Buoy over the Side**

---

### **B.7 Setting a Buoy using Chain and a Sinker**

When setting buoys using chain and a sinker, the sinker is positioned at the deck edge or on the dump-board, the chain is coiled, faked, or flemished on top of the sinker or on the deck. The sinker is set, then the buoy. If the capstan method was used to recover the mooring, and the deck is configured with a chain stopper, the sinker is lowered to the bottom with the capstan. Once the sinker is on the bottom, the chain is placed in the chain stopper using chain hooks and the remaining chain is faked on deck. The buoy is placed on the deck edge, the chain stopper tripped, and the buoy is launched over the side. Pelican hooks can be used in lieu of or as a back up to a chain stopper.

---



- 
- a. When near the position where the buoy will be set, the Conning Officer gives the command to **“STAND BY A CAN/NUN BUOY.”** Upon this command, deck personnel will place the buoy in the buoy port and take their positions. These positions include one BDS, two personnel tending the buoy, and one person tending the dump board.
  - b. When all deck personnel have taken their positions and have ensured that the chain mooring is clear of all deck fittings, the BDS will inform the Conning Officer **“READY ON DECK”**.

**WARNING** 🖐️

**Cleats and/or chain stoppers may be located in the area between the dump boards and buoy port. It is important to ensure that the chain connecting the sinker to the buoy is not fairlead on the inboard side of any of these fittings to prevent fouling upon setting the sinker and buoy.**

- c. As the position where the buoy is to be set approaches, the Conning Officer gives the command to **“STAND BY.”** The deck crew will pull the pin on the dump board. The BDS will inform the Conning Officer **“READY ON DECK.”**
- d. When the cutter has maneuvered into the position where the buoy is to be deployed, the Conning Officer will give the command, **“SET IT.”** The deck crew trips the dump board, jettisoning the sinker overboard, and pushes the buoy over the side.
- e. Once the buoy has been deployed and the BDS has confirmed that the buoy, mooring, and sinker is clear of the deck, the BDS will tell the Conning Officer **“BUOY AWAY, ALL CLEAR.”**
- f. The vessel is then maneuvered at a safe speed away from the buoy.

## **B.8 Positioning**

Placement of buoys on Western Rivers is done to mark a channel of a specific minimum depth and with the maximum width possible.

- a. The WLR Officer-in-Charge has wide discretion in positioning Aids to Navigation. This authority is spelled out in CCGD8 SOP Section 22.
  - b. The position of buoys on pooled rivers remains fairly constant. Shoaling does occur, but rarely does the channel shift dramatically as it may on the uncontrolled rivers. Because of infrequent shifting, buoy positions are more easily determined using landmarks and bottom soundings. In other areas, WLRs must rely on water depth to determine the position of the buoys and width of the channel to be marked.
-





---

**B.9 Dragging  
a Buoy**

This method is used when the buoy needs to be re-positioned a short distance from the cutter's location and recovering the buoy and mooring is not required.

- a. Lay out all the equipment to be used and conduct a safety brief.
  - b. When the deck is set up and the crewmembers are ready, pass to the bridge, "**READY ON DECK.**"
  - c. Maneuver the appropriate buoy port alongside the buoy to be serviced ensuring that there is adequate safe water for maneuvering around the buoy.
  - d. The bridge will give permission by passing: "**HOOK IT WHEN YOU CAN.**"
  - e. Steady the buoy with a boat hook and reeve the lifting bail with line and a rated piece of drag chain. The chain should be attached to a padeye on the barge and attach the other end back to a cleat/bitt or run it through the chain stopper.
  - f. Ease the tender back, breaking free the sinker from the bottom.
  - g. Once the sinker is broke free, the BDS reports "**BUOY IS FETCHED**" and the tender moves ahead, dragging the buoy and mooring to the new position.
  - h. Once in position, the bridge will pass "**SET THE BUOY.**"
  - i. Depending on the set up, either the chain stopper is tripped or the cleat/bitt is cleared, freeing the drag chain from the barge and releasing the buoy.
  - j. Once the buoy is set and the gear is recovered, pass to the bridge "**BUOY AWAY, ALL CLEAR**".
-



## Section C. WLR Special Evolutions

**Introduction** Occasionally, River Buoy Tenders may be required to deviate procedurally from the standard buoy evolution outlined above. These occasions include, but are not limited to handling a fouled mooring, working a buoy without lifting bails, searching for and recovering a sunken buoy, and retrieving a beached buoy. Prior to executing any buoy deck operations, all weight handling gear shall be inspected and exercised.

**C.1 Deviation from Standard Procedures** Since the following Special Evolutions deviate somewhat from the standard evolution, the Safety Supervisor and Buoy Deck Supervisor **shall** ensure that all deck crew members are sure of and comfortable with their roles in the evolution.

**C.2 Fouled Mooring Chain** Twisted (sometimes referred to as kinked) mooring chain often occurs in areas of rotary current or when the buoy swivel is not operating properly. Over time, a twist will develop into a knot. A knot in mooring chain generally develops in three different ways: (1) from twisted chain, (2) when the bottom chain wraps around the sinker, (3) when mooring chain becomes fouled with a foreign object.

**CAUTION!** **Be aware that a mooring may be fouled with a sunken buoy or other object that could exceed the lift capacity of your weight handling gear.**

**C.2.c Clearing the Knotted /Fouled Mooring** Having a knot unravel during the recovery effort could shock load weight handling gear causing serious damage. Therefore, hoisting a mooring aboard the vessel from above the knot or fouled section is NOT considered an acceptable recovery method. Instead, the first objective of the recovery is to remove the strain from the knot or fouled section of the chain; in a sense, isolating the knot. The following are some general procedures for handling a knot or fouled mooring:

(1) Ideally, the best way to isolate the knot is to hook a hoisting purchase into the moor below the knot, usually via a sling. Once the purchase is rigged in this way, the knot can be brought aboard and the chain below the knot secured in the chain stopper or pelican hook. At this point, the knot can be removed from the moor by unraveling or cutting it from the rest of the mooring.

(2) It may not be possible to hook a hoisting purchase into the chain below



---

the knot. In those cases the best alternative may be to have the vessel drag the mooring away from its position and release it in safe water.

- (3) Another less desirable alternative is to “choke” the knot with a sling, hook the purchase into that sling, and bring the knot aboard. This method involves more risk, as the knot may suddenly unravel, which could shock load weight handling gear causing serious damage.
- 

**C.2.d Cleared Mooring**

After the knot or fouled section or mooring has been cleared, standard evolution procedures are followed.

---

**C.3 Recovery of Stray or Stranded Buoys**

A River Tender is required to recover stray, stranded, and scrap buoys. Typically, the WLR will utilize the cutter boat for this task; however, some circumstances may be more safely accomplished by the cutter and barge. If the cutter is used to recover the stray buoy, extreme care should be exercised and a thorough brief shall be conducted prior to the evolution.

---



## Section D. ATON Work Ashore

---

<b>Introduction</b>	The Eighth Coast Guard District's SOP Section 22, contains administrative and policy guidance for ATON placement in the Eighth Coast Guard District. While this section deals with the general seamanship practices of the WLRs on the Western Rivers of the Eighth Coast Guard District, consult the Eighth District SOP for specific guidance on these issues.
<b>D.1 Shore Aid Location and Servicing Tasks</b>	Servicing aids on rivers can be challenging depending on the location. For instance, unlike the Upper Mississippi River, brush and tree cutting on the Lower Mississippi is a major task when servicing aids ashore. However, most structures do not require painting since pilings are pressure treated and towers are galvanized.
<b>D.2 Shore Aid Survivability</b>	Survivability is an issue with shore aids on some of the rivers during flood season. In some cases, these structures have to be frequently moved either because of channel changes or eroding banks caused by changing water levels. As a result, many structures are lost, destroyed, or rendered unserviceable from these conditions. During high water when rivers overflow their banks, the lights and associated electrical gear can be removed from shore structures, if feasible, until the river recedes sufficiently to replace them.
<b>D.3. Building Shore Structures</b>	Constructing shore structures along rivers requires much ingenuity and common sense. Some of the trouble with building structures has been solved by the use of "Triangle or Rohn Towers" (3-legged, cross braced, metal structures) (See <b>Figure 11-11.</b> ) These metal towers are erected in sections with a base plate of either a sinker or spike plate and guy wires. Do not attempt to climb a tower structure until you have double checked all guy wires and made sure that the structure is stable. The sand anchors should be firmly anchored in the ground. Anchors have been known to pull out of soft ground or after heavy rains. Become familiar with the requirements in the Aids to Navigation Manual - Structures (COMDTINST M16500.25 (series)) for using guy wire on towers.
<b>D.3.a. Climbing Structures</b>	Prior to commencing climbing operations on any tower or structure, personnel shall be trained and outfitted in accordance with the Aids to Navigation Manual - Structures (COMDTINST M16500.25 (series)). Generally, river shore structures are elevated as high as possible to prevent or reduce the possibility of loss during high water in a flood stage. Do not attempt to climb a structure or steps that appear rotten or weak. If using an



---

extension ladder, be sure that it has enough of a support angle when leaned against the structure to safely support the climber. Once the servicing technician is on the tower, all hands should stand clear of the tower. Tools should be raised and lowered to the technician on the tower using a lanyard to prevent them from falling and injuring personnel on the ground.

---



**Figure 11-11**  
**10ft Rohn Tower Section**

**D.3.b. Brushing  
Around  
Structures**

When clearing brush, you must be constantly aware of the location of all persons in the work party and the location of the guy wires and anchors. Stay clear of the guy wires while the tower is occupied. When felling trees, take care in choosing a landing site and escape route before commencing. Make sure a large enough clearing exists before a tree is permitted to fall.

**CAUTION!**

**Always be sure of your footing and make sure that brush, vines, etc., are clear from overhead before swinging an axe or brush hook.**

**NOTE** *↪*

**All persons who use chain saws, brush cutters, etc., must have received adequate training and wear proper protective equipment (safety glasses, hard hats, chaps, etc.).**

**D.3.c. Tower  
Components**

All tower structural parts and materials should be precut or pre-assembled as much as possible and ready to be erected on the spot. Units should carry extra towers, sand anchors, guy wires, and lumber to repair or replace towers or structures, or their individual structural components, as needed.

---



<b>D.3.d. Building Lighted Aids</b>	If required to build a lighted shore aid, lighted shore aids shall be built and equipped in accordance with the Aids to Navigation Manual - Structures and Aids to Navigation Manual – Technical.
<b>D.4. Hazards and Wildlife Encountered During Servicing</b>	Servicing shore aids will be accomplished in accordance with the Aids to Navigation Manual - Technical. The method of servicing river structures is similar to the procedures described for other structures elsewhere in this manual. However, some unique challenges exist. Lights along railroad tracks will need shields to keep the lights from shining toward the tracks. High bluffs and vegetation often interfere with solar panels and will require larger than normal panels or creative placement to get adequate exposure. Steep hills may require the use of block and tackle rigs to get gear up to the structures.
<b>D.4.a. Working Around Insects</b>	Wasp nests are often found on shore structures and in battery boxes with the screens missing. A good spraying of the battery box with commercial insecticide, which can be applied from a distance, will often mitigate the wasp or hornet problem before servicing. Another deterrent to insects is to place moth balls inside the battery box. In any event, use caution when working on structures. An unexpected wasp sting could cause you to lose your balance and fall. Also be aware of any personnel on the work party who may be allergic to bee or wasp stings and carry adequate first aid treatment.
<b>D.4.b. Insecticides</b>	Some insecticides are made with volatile petroleum hydrocarbons, such as gasoline, kerosene, or naphtha. These solvents may be harmful to people and plastics. An alternative should be sought out that is less hazardous to servicing personnel.
<b>D.4.c. Snakes</b>	Snakes also pose a problem during certain times of year. Personnel should be careful that they do not place their hands or step where they cannot see. Sunny rocks and platforms are a favorite early morning and evening haunt of snakes when the temperatures begin to drop. A little caution and respect will prevent accidents.
<b>D.4.d. Poisonous Plants</b>	Poison ivy, poison oak, and poison sumac will move rapidly into the fringe of clearings around structures. Personnel should be familiar with local plant appearances and wear clothing that will minimize direct exposure.



NOTE ↪

**Brushing during the winter months reduces the likelihood of coming into contact with insects, snakes, and mitigates heat exposure. Brushing is also facilitated by the lack of foliage on trees and brush. Because of the extra layers of clothing being worn, the risk of exposure to poisonous plants is also reduced.**



## Section E. Cutter Boat Operations

---

**Introduction** Occasionally, the River Tender may be required to launch the cutter boat to recovery a stray buoy or one that cannot be reached by the cutter. This section covers the processes to be followed while using the cutter boat.

---

**E.1 General Precautions** General precautions that relate to any evolution shall be taken into account and exercised prior to the boat getting underway from the cutter. These precautions include:

- a. Risk Assessment (i.e., GAR Model)
  - b. Evaluation of weather and other environmental factors.
  - c. Evaluation of current and hazards in the area (i.e., submerged dikes)
- 

**E.2. Crew Requirements** **The minimum crew requirements described in reference (b) are minimum requirements. Three personnel are required for cutter boat operations when slipping buoys or servicing Aids to Navigation ashore, except when doing so would exceed the boat's maximum weight capacity. The personnel shall consist of a coxswain and two crewmembers; one of the crewmembers may be a break-in. For all other ATON operations, units shall follow the minimum boat crew requirements specified in reference (b).**

---

**E.3 Floating Buoy Task List** Because the area of operations and operating environment varies greatly between cutters, it is hard to standardize the evolution and come up with a step by step checklist. The following procedures should be followed for recovering a buoy in an area where the cutter cannot safely navigate and deviations shall be minimized as much as possible. If towing a buoy alongside, the towline shall be rigged to slip.

- a. Approach the buoy to be slipped into the prevailing current, but not directly downstream from the buoy.
  - b. Grab the buoy in a way to rotate it so the shackle will rotate inboard (between the buoy and cutter boat), this is normally accomplished by grabbing one of the outboard lifting eyes on the buoy.
  - c. As the cutter boat slowly comes ahead (into the current), the buoy will gain some slack in the mooring, this will allow the buoy to rotate up and lay up against the small boat's hull.
-





- 
- d. If the cutter boat goes ahead too fast or too far, there will not be enough slack in the mooring to allow the buoy to float up against the small boat. If this happens, release the buoy, drift down current, and make another approach to the buoy.
  - e. Once the buoy is floating alongside the cutter boat, the crewmember holding the buoy will release the shackle connecting the buoy to the mooring.
  - f. Once the mooring is cast off, the buoy is towed back to the barge and recovered using the standard evolution from the river using the procedure in B.2.b above.
- 

#### **E.4 Beached Buoy Task List**

The following procedures should be followed for recovering a buoy in an area where the cutter cannot safely navigate. Deviations from this task list shall be minimized as much as possible.

- a. If a buoy has washed up on a bank and the buoy is deemed to be safely recoverable, the cutter boat shall be launched to recover the buoy.
- b. Once on scene, the boat crew will determine the feasibility of recovering the buoy and the best plan of action to re-float the buoy.
- c. If the buoy cannot be placed in the boat, a line shall be secured between the buoy and cutter boat.
- d. Once the buoy is refloat, the buoy shall be secured to one of the bow cleats on the cutter boat and towed alongside the cutter boat back to the cutter. (See **Figure 11-12**)
- e. When the cutter boat arrives alongside the cutter with the buoy in tow, the standard evolution for the cutter and barge shall be used, see paragraph B.2.b above. (See **Figure 11-13**)



**11-12**  
**Securing a Refloated Buoy**

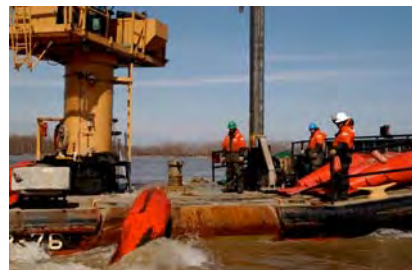

**11-13**  
**Refloated Buoy Being Recovered by Cutter**



## Chapter 12

# Inland Construction Tender Operations

---

**Introduction** This chapter represents an overview of ATON construction operations aboard the 75, 100, and 160 foot class Inland Construction Tenders. This chapter is not intended to cover all evolutions that these cutters might encounter while conducting construction operations. However, the safety rules covered in this manual and other applicable publications, standard evolution procedures, and sound seamanship practices shall be followed whenever engaged in construction and weight handling evolutions.

---

**In this chapter** This chapter contains the following sections:

Section	Topic	See Page
A	Basic Construction Equipment and Materials	12-3
B	Construction Deck Evolution	12-7
C	Special Evolutions	12-13



This page intentionally left blank



## Section A. Basic Construction Equipment and Materials

### Introduction

This section contains the general description and characteristics of buoy deck equipment on the 160ft, 75ft, and 100ft WLIC cutter classes.

Personnel are also encouraged to find relevant information in the Naval Engineering Manual, COMDTINST M9000.6 (series) and applicable technical publications.

### A.1 Crane Characteristics and Description

The 75ft and 100ft WLICs push a 68ft, 70ft, or 84ft construction barge. The primary construction equipment – a CG-300 lattice boom pedestal mounted crane and a diesel powered pile-driving hammer (See **Figures 12-1 and 12-2**) – are located on the barge. All construction operations are conducted from the barge. Since the 160ft WLIC is a single-unit vessel, the CG-300 crane and pile driving hammer on these cutters is located at the bow of the cutter where they conduct construction operations.

Most WLIC construction operations consist of repairing, dismantling, or building a variety of ATON structures as well as recovering the wreckage of destroyed ATON structures. Typically, these operations require driving wood or steel pile(s) into a variety of bottom types. Rebuilding and repairing efforts may also require extracting damaged pile(s) from the bottom. Occasionally, WLICs are also tasked with other construction projects, such as repairing or rebuilding Coast Guard piers and docks, installing mooring dolphins, and other similar operations.

#### A.1.a CG-300 Lattice Boom Crane

The CG-300 cranes aboard WLICs are outfitted with either a 70ft lattice boom (aboard the 160ft WLIC and the 84ft construction barges) or 60ft lattice boom (cranes on the 68ft and 70ft construction barges). The CG-300 crane has three separate purchases; a two-part main purchase (#1), and two single hoists (#2 and #3). The main purchase is rigged through the center sheave, #2 hoist is rigged through the left sheave (as viewed from the crane cab), and #3 hoist is rigged through the right sheave (as viewed from the crane cab). This crane is also rigged with an eight-part topping lift and a self-contained slewing mechanism. More detailed information about this equipment, as well as the operation, maintenance, and inspection procedures for this equipment, is contained in the latest version of USCG Technical Pub #1952.

### CAUTION!

**The #1 hoist shall be rigged in the two-part purchase configuration. Failure to do so could result in personnel injury or equipment damage.**



**A.1.a.1 70’  
Crane  
Characteristics**

The 160ft WLIC and the 75ft WLIC with 84ft Barge both use the 70ft crane (See **Figure 12-1**).

Maximum Swing Range	360 Degrees
Boom Angle (min/max)	17 Deg to 80 Deg
Boom Length	Fixed – 70’’
Maximum WLL	4000lbs @ 70’’ radius, 18,000lbs @ 25’’ radius and closer
Wire Rope (Topping)	625’’ of 5/8in 6x37 EEIPS RRL IWRC
Wire Rope (Main)	270’’ of 5/8in 6x37 EEIPS RRL IWRC
Wire Rope (Hoists)	170’’ of 5/8in 6x37 EEIPS RRL IWRC
Maintain a minimum of 5 wraps of wire rope on drums at all times	

**A.1.a.2 60’  
Crane  
Characteristics**

The 75ft WLIC with 68ft barge and 100ft WLIC (SMILAX) with 70ft Barge both use the 60ft crane (See **Figure 12-2**).

Maximum Swing Range	360 Degrees
Boom Angle (min/max)	17.7 Deg to 80 Deg
Boom Length	Fixed – 60’’
Maximum WLL	6000lbs @ 60’’ radius, 18,000lbs @ 25’’ radius and closer
Wire Rope (Topping)	545’’ of 5/8in 6x37 EEIPS RRL IWRC
Wire Rope (Main)	240’’ of 5/8in 6x37 EEIPS RRL IWRC
Wire Rope (Hoists)	150’’ of 5/8in 6x37 EEIPS RRL IWRC
Maintain a minimum of 5 wraps of wire rope on drums at all times	

**A.1.b SMILAX  
Crane  
Information**

The SMILAX has a 27ft tubular boom equipped with five-part main and single ship hoisting tackle that uses 7/16-inch wire rope. The working load capacity is 10,000 pounds when rigged as a five part purchase and 6,000 pounds when rigged as a three part purchase. The working load capacity of the hoist is 2,000 pounds at 60 feet per minute. The hoister comprises three individual single drum clutch and contracting brake type winches driven by compressed air motors that develop 2,000 pounds of line pull at 60 feet per minute. Each winch will withstand a static pull of 14,600 pounds. The hoist, located on the end of the boom, uses 65 feet of wire, the main uses 170 feet, and the topping lift uses 140 feet of wire. The blocks are a 10-inch steel double sheave block. Many of the inland waterways tenders use a stubby kingpost instead of the conventional-type mast for supporting the boom.



**A.1.b.1  
SMILAX Crane  
Characteristics**

Maximum Swing Range	360 degrees each
Maximum WLL (Main)	10,000 lbs @ 26" radius,
Maximum WLL (Hoist)	2,000 lbs @ 30" radius, maximum outreach
Boom Angle (min/max)	0 - 75 degrees
Boom Reach (max out reach)	30"
Wire Rope (Main)	150" of 1/2" 6x37 RRL XIP IWRC
Wire Rope (Hoist)	100" of 3/8" 6X37 RRL XIP IWRC

**NOTE**  The SMILAX (WLIC-315) is a hybrid unit that will work buoys as a WLI whenever it is decoupled from its barge.



**Figure 12-1  
70ft CG-300 Crane**



**Figure 12-2  
60ft CG-300 Crane**

**A.2 Crossdeck  
Winches**

Since there is no standardization of the type, number, location, and characteristics of crossdeck winches aboard WLICs, this manual does not list them for each WLIC. Personnel should refer to cutter-specific drawings and applicable technical publications to obtain details about the crossdeck winches aboard their cutter.



**A.3 Diesel Powered Pile-Driving Hammer.**

---

All of the WLICs are outfitted with a diesel powered pile-driving hammer, a Delmag model D-6 or its replacement, the Pileco D6-42(See **Figures 12-3** and **12-4**). These hammers are single cylinder diesel engines, which delivers their primary downward force on the pile when the piston fires. They are very effective for driving wood and steel piles into most bottom types. Detailed information on the pile driving hammers, as well as the operation, maintenance, and inspection procedures are contained in the latest version of Coast Guard Technical Publication #3124.

---

**A.4 Vibratory Pile Extractor/Driver.**

In addition to the diesel hammer, some WLICs have used a vibrating pile extractor/driver to remove and drive piles. This type of pile extractor/driver works by shearing the soil-to-pile adhesion causing the soil particles to lose their frictional grip and allow the pile to move downward under the combined weight of the driver and pile. Vibratory hammers do not work on hard bottom types like rock or coral.

- (1) For special ATON projects or wreckage/pile removal, vibratory pile drivers are available for rent from commercial sources on a monthly or weekly basis. Contact the appropriate Sector, District (dpw), or CEU for guidance and contracting assistance for obtaining a vibratory pile driver.
  - (2) Vibratory hammers are very effective on non-displacement piles such as open-end steel pipe. Vibratory hammers are less effective for displacement piles such as concrete, timber, and closed-end pipe where the soil particles must be displaced more to allow the pile tip to move downward.
- 

**A.5 Spuds**

The construction barges and the 160ft WLICs are equipped with either three or four spuds ranging in length from 35-45 feet. Spuds are designed to keep the cutter stationary for construction and buoy operations. Prior to commencing construction operations spuds shall be securely set into the bottom.

---



**Figure 12-3  
Hammer and Lead in Cradle**



**Figure 12-4  
Hoisting Hammer and Lead**



## Section B. Construction Deck Evolution

**Introduction** This section covers the WLICs primary mission of constructing ATON using the crane and other equipment on the barge.

**B.1 Pile Loading** Prior to conducting an ATON construction evolution, piles must be loaded on the construction deck. ATON piles are loaded onto the construction deck in the horizontal position. A two-legged sling is used for this purpose. These slings are fitted with hooks (for wood piles) or special end fittings (for steel piles).

**B.1.a Wood Piles** Wood piles are typically hoisted in bundles of about three piles, to avoid exceeding the WLL of the crane. A short wire rope sling is choked at each end of the bundle of wood pile(s). The hooks from the sling are hooked into these chokers. Wood piles are approximately 12 inches in diameter and commonly come in 40ft, 50ft and 60ft lengths.

**B.1.b Steel Piles** Steel piles are 12 inch and 18 inch diameter and commonly 50ft and 60ft lengths. Steel piles are loaded individually. Although a choker can be used on steel piles, like wood piles, typically a sling is fitted with special end fittings that hook into the open ends of the steel pile.

**B.1.c Pendulum Effect** Extra care must be exercised when hoisting and moving these extra long loads. The pendulum effect on these loads is magnified due to the length of the load, the height of the crane and effects of wind and other elements. Steadying (tag) lines must be used at each end of the load for control, particularly when loading piles to the outboard pile rack on the construction deck.

**WARNING**  **Due to potential for personnel injury and equipment damage, the use of tongs or hooks in loading piles is not authorized. Only the use of slings, straps, or hooks that firmly secure the ends of the pile(s) are authorized.**

**CAUTION!** **Special care should be taken when dragging piles on deck to keep side loading of the boom to a minimum.**

**B.2 The Approach** Before approaching an aid, determine that the aid is on its assigned position, that the position is clear of any obstructions and that there is no wreckage. The assigned position of a fixed aid is approached on the bow using Automated Aid Positioning Software (AAPS) program.





---

**B.3 Depth of Water**

The construction tender must carefully take into account the depth of water and tide range when building fixed ATON structures.

---

**B.3.a Mean High Water**

The depth of water must be determined at the site of each structure. Tide corrections must then be applied to determine mean high water (MHW). Determining MHW is critical in determining the proper height to drive the pile for correct placement of dayboards and focal plane of the light. This is of particular importance in areas with large tidal ranges.

---

**B.3.b Depth Limitations**

The construction tender is generally limited to driving piles in water not greater than 20ft. In water greater than 20ft, the spuds are fully extended and cannot achieve adequate bottom penetration to keep the cutter in place and stable. In addition, with the spuds extended, the spud is unnecessarily susceptible to damage from wind, wakes or other environmental conditions.

---

**B.4 Determining the Pile Length**

Having determined the projected and actual depth of water at the assigned position (AP), the length of pile needed can be determined. The minimum required pile length is determined by the following formula: [(Focal plane minus the distance of the optic above the pile top) plus (Water depth plus tide correction) plus (required penetration)]. For example, if the required focal plane of a light is 17 feet. The optic will be 4 feet above the top of the pile. The water depth at AP is 10 feet and the tide is minus 2 feet. The required penetration for the specific seafloor type is 17 feet. The formula therefore is  $(17-4) + (10+2) + 17 = 42$  minimum pile length. The top of the pile needs to be 15 feet above the waterline: Focal plane minus the distance of the optic above the pile top plus the tide correction --  $(17-4+2) = 15$ .

---

**B.4.a Cutting Piles Prior to Driving**

If a pile needs to be cut, it is safest to cut the pile prior to driving. Ensure that the pile is cut squarely with the axis of the pile so the pile will receive the full force of the hammer blows.

---

**B.4.b Pointed Piles**

The tip of wood piles should not be sharpened to facilitate driving. Metal points, or pile shoes, can be nailed to the tip of wood piles to facilitate driving piles into a hard bottom. Steel piles are driven in nearly the same manner as wooden piles and can be fitted with a point steel toe to aid in penetrating hard bottoms.

---

**B.5 The Evolution**

The following sections describe the construction deck evolution once the cutter is spudded down on the aid's assigned position:

---

NOTE 

**Prior to beginning any construction deck operations, all weight handling gear shall be inspected and exercised as per Chapter 4 and applicable maintenance procedure cards.**

---



- 
- a. Lift the hammer and lead from its cradle and position it at the appropriate point on the bow for building the aid.
  - b. Inspect the hammer and prepare it for pile driving in accordance with CG Tech Pub #3124. This includes performing a blow-down prior to the start of each day's work.
  - c. Use the #1 main hoist to position the lead and use the #3 hoist to raise the hammer into position in preparation to receive the pile. The #3 hoist is used for the hammer because of its ability to operate at variable speed while the hammer is engaged.
  - d. Prepare the pile for lifting. Attach the #2 hoist to the upper end of the pile using a choker hitch (wood) or round turn and choker hitch (steel) (See **Figure 12-5**). Attach the crossdeck / tugger winch to the lower end of the pile with a choker hitch (wood) or shackle (steel). This will provide positive control of the pile while lifting (See **Figure 12-6**).
  - e. Hoist the pile with the #2 hoist while paying out wire from the crossdeck / tugger winch. Lift the pile until it is vertical and position it under the helmet of the hammer. Close the bail on the lead.
  - f. Lower the #2 and #3 hoists with the hammer and pile and set the pile onto the bottom.
  - g. Lower the #3 hoist and using the weight of the hammer, push the pile into the bottom as far as possible using the weight of the hammer alone.
  - h. Prior to engaging the hammer, ensure the pile is plumb in a vertical position. Use a level on a steel pile.
  - i. Using the control lines, set the fuel pump level and engage the piston.
  - j. Using the #3 hoist, raise the piston until it hits the trip allowing the piston to free fall until it hits the drive plate.
  - k. Continue to raise and drop the piston, while adjusting the fuel pump level, until the hammer fires and continues to run on its own.

**NOTE** 

**Remember to continually lower #2 and #3 hoists, keeping slack in the wire, as the hammer drives the pile into the bottom. Failure to keep slack in the #2 hoist may result in damage to the hammer or the purchases of the crane.**

1. Once the pile is firmly seated into the bottom, remove the #2 hoist from the pile.
-



Figure 12-5  
Crane Hoisting Pile



Figure 12-6  
Cross Deck Winch Easing Out Pile

NOTE 

Depending on bottom type, the hammer may not continue to fire on its own. Continue with steps ‘i’ and ‘j’ until the hammer fires or until the pile reaches the appropriate height.

NOTE 

In some cases, the pile may reach refusal before reaching the appropriate height. Discontinue pile driving operations and trim the pile to the appropriate height before attaching the platform or dayboards.

NOTE 

If the hammer does not fire with the pile in a hard bottom, follow troubleshooting procedures in CG Tech Pub #3124.

- m. Ensure the piston is not engaged, ease the control line, slowly come up on #3 hoist to allow the carrier to contact the lifting points on the hammer, continue coming up on #3 hoist and raise the hammer off the pile.
- n. Open the bail.

**B.6 Cutting Pile  
Tops After  
Driving**

The correct height of the pile can be determined by the determining depth of water, pile height at Mean High Water and the required focal plane of the light. In some cases, the pile cannot be driven to its required penetration because of an exceptionally hard bottom. However, if fixity is obtained, the pile is left in place and the top is cut off at the correct height.



### B.6.a The Top Portion of the Pile

Before cutting, a strap must be placed on the top portion of the pile to maintain control and prevent its falling either into the water or on deck. Place the strap above the point of balance, as near the top as possible. Attach a tag line to the top portion for control. The crane operator must watch for the pile to be cut to prevent excess swinging of the top portion after cutting.

- (1) On wood piles, a chain saw is used to cut the pile. Ensure personnel are qualified chain saw operators and are outfitted in the proper PPE.
- (2) On steel piles, an oxy-acetylene torch is used to cut the pile. Ensure personnel are qualified as an Oxy-Acetylene operator and are outfitted with the proper PPE.

### WARNING

**Chain saw operators shall never cut piles above the level of their shoulders while standing. Otherwise, the operator may lose the ability to fully control the saw. (See Figure 12-7 and 12-8)**

### B.7 Pile Driving and Structure Considerations

A close eye must be maintained on the pile's progress to monitor if it reaches refusal. Refusal is defined as when the last 20 blows of the diesel hammer will not drive the pile more than an average of 1/8 inch per blow. Piles are usually embedded in the bottom with a steady succession of blows on top of the pile with the diesel hammer. For those locations with soft bottom conditions, the dead weight is usually sufficient to embed the pile to the minimum penetration.



12-7  
Cutting Pile Top



12-8  
Cutting Pile Top

### B.7.a Driving beyond Refusal

If a wood pile has been driven to refusal, the pile head may begin to broom excessively or split. If the pile must continue to be driven, the pile must be assisted by jetting. If a steel pile reaches refusal, the pile will not penetrate further.



---

**B.7.b  
Obstructions**

If a pile appears to reach refusal after a short distance, it may be an indication that a boulder or obstruction has been encountered. In such cases the pile should be pulled and a new one driven in an alternate location.

---

**B.8 Jetting**

Jetting is the use of water pressure supplied through a pipe alongside the pile to facilitate pile driving. The purpose of jetting is to loosen the soil under the point of the pile by water pressure. It is most useful in sinking piles when pile driving equipment is not available. It may be used alone or with compressed air or a weighted pile. A weighted pile is one with a sinker, or other heavy object, resting on top of it.

---

**B.8.a Jetting in  
Conjunction  
with Driving**

Jetting is also useful in assisting the driving of piles with standard pile-driving equipment in hard bottom conditions and is especially effective in sand and gravel bottoms. The jetting water should be delivered to the pile point in sufficient volume and pressure to wash away the soil from under the point and to reduce the friction of the soil around the pile body. After the pile has reached its desired penetration and the jetting stopped, the soil settles naturally around the pile to retain the pile in position. When jetting is used with pile driving equipment, jetting is usually discontinued a few feet before final penetration is reached. The pile is then driven the remainder of the distance with the hammer alone. Fire pumps delivering 150 or more gpm make excellent jetting pumps.

---

**B.8.b Securing  
the Jetting Pipe**

The jetting pipe can be secured to the wood pile by means of staples and straps nailed in such a manner that the pipe can be pulled free. Usually, it is best to keep the jetting pipe in constant motion up and down and around the pile. Generally, it is easier to suspend the jetting pipe from an overhead rig to permit its free movement around the pile being driven.

---

**B.8.c Post-  
Jetting Time**

After a pile has been jetted, allow time to permit the soil to settle around the pile to stabilize it. Usually, 30 minutes is a sufficient amount of time for the soil around a pile to settle before installing lighting equipment. Dayboards can usually be safely installed right away.

---

**B.9 Completing  
the Structure**

For detailed descriptions of structure types, lighting, and signal requirements, follow those specifications in the Aids to Navigation Manuals - Technical, COMDTINST M16500.3 (series) and Aids to Navigation Manual -Structures, COMDTINST M16500.25 (series).

---



## Section C. Special Evolutions

**Introduction** Although the ATON mission of WLICs consists primarily of repairing and building ATON structures, they are occasionally required to perform buoy maintenance. The following section outlines the standard buoy evolution aboard WLICs using the CG-300 crane.

**C.1 Buoy Recovery Evolution** Before approaching the aid, determine that the aid is on its assigned position, that the position is clear of any obstructions and that there is no wreckage. The following is the standard buoy evolution for hoisting a lighted or unlighted buoy aboard a construction tender. This evolution begins once the cutter is spudded down on AP.

**WARNING** 

**The CG-300 lattice boom crane shall not be side loaded. Therefore, spuds must be set before commencing weight handling operations.**

- a. With the buoy close on the bow and with permission from the bridge, hook the appropriate buoy lifting bail using a picking pennant.

**NOTE** 

**Typically a synthetic sling or picking pennant is hooked to the buoy lifting bail and secured to the #1 main or #2 or #3 whip hoists.**

- b. Attach tag lines to the buoy and / or lifting hook.
- c. Hoist the buoy and maneuver the chain over the chain stopper or use a pelican hook to secure the chain on deck. Use available deck winches to help seat the chain and steady the buoy while lifting.

**WARNING** 

**DO NOT hoist the buoy, chain and sinker in one continuous lift using the buoy lifting bail. The buoy bail is designed to lift the buoy only and is not designed to support the weight of the buoy with the chain and sinker attached.**



- 
- d. Lower the hoist until the chain sets into the chain stopper, if used. This can be assisted by using a crossdeck winch or by using a chain hook or boat hook.
  - e. Once the chain is set in the chain stopper or pelican hook, lower the buoy and secure it on deck with the appropriate number and size of gripes.
  - f. Disconnect the mooring chain from the buoy.
  - g. The buoy is now ready to be serviced or the relief buoy is prepared to be attached to the mooring chain.

If necessary, complete the following steps to pull chain or to recover the sinker.

- h. The mooring chain and sinker is now prepared to be hoisted on deck or sufficient chain is pulled for the buoy to be put back into the water.
- i. The crane is positioned over the chain stopper and the bitter end of the chain is attached to the hook.
- j. Commence pulling chain.
- k. Pull enough chain to hang the buoy, or hoist the chain and sinker onto the construction deck.

---

## C.2 Buoy Setting Operations

The following is the standard buoy evolution for setting a lighted or unlighted buoy aboard a construction tender. The following steps assume that the buoy, mooring, and sinker are onboard. If only the buoy is onboard and the sinker is still on the bottom, skip to step „g“:

The following are steps when the mooring chain and sinker have been recovered on deck.

- a. Request from the bridge, “PERMISSION TO LOWER THE SINKER”  
The bridge will reply, “LOWER THE SINKER.”
- b. The crane hoist is hooked into the chain at point that will allow sufficient length of chain for the sinker to reach the bottom with the chain in the chain stopper **AND** with sufficient length of chain at the bitter end to reach from the chain stopper to the buoy.
- c. The chain and sinker are lifted and lowered into the water.
- d. Maneuver the chain over the chain stopper.
- e. Lower the hoist until the chain sets into the chain stopper. This can be assisted by using a crossdeck winch or by using a chain hook or boat hook.
- f. Lead the bitter end of the chain over to the buoy and continue with Step



„g“below.

Complete the following steps if the chain and sinker have not been recovered on deck.

- g. When the buoy servicing is completed or the relief buoy is prepared to go into the water, the buoy is ready to be put back into the water.
- h. Request, “PERMISSION TO SHACKLE AND FLOAT” the buoy from the bridge.
- i. Once permission is obtained, attached the mooring to the buoy and remove the gripes.
- j. Deck personnel „man“ their perspective positions and inform the Construction Deck Supervisor (CDS) that their positions are manned and ready.
- k. The buoy is hoisted and maneuvered over the bow and set into the water.
- l. The picking pennant hook is now removed and the buoy is allowed to float free. The buoy is controlled clear of the chain stopper with a tag line or boat hook.
- m. When ready to set the sinker, the phrase “READY ON DECK” is passed to the bridge. The bridge replies “STAND BY.”
- n. The CDS directs to remove the chain stopper pin. Once the pin is removed, the rigger will standby to strike the chain stopper strike plate with a sledgehammer.
- o. The bridge will pass, “SET THE BUOY.” The CDS then directs the rigger to trip the chain stopper.

**C.3 Wreckage**

When a construction tender arrives on scene to rebuild a knocked down or destroyed aid, the location usually has been marked with either a TRUB or TRLB by the local Aids to Navigation Team (ANT). It is the responsibility of the ANT or primary unit to recover wreckage (if able) and wire sweep to determine that no hazard exists.

**C.3.a Locating Wrecks**

If the primary unit is unable to wire sweep the area, the construction tender must wire sweep or otherwise ensure that no portion of the old pile(s) or structure remains above the mud line or that no hazard exists.

**NOTE** *↪*

**THIS RESPONSIBILITY CANNOT BE OVEREMPHASIZED. The area MUST BE wire swept to ensure that no portion of the old Coast Guard structure remains.**





---

**C.3.b Removal of Wreckage**

After the wreckage is located, it shall be properly marked or recovered (if possible). If the wreckage cannot be recovered, the new aid shall be built channel-ward of the wreckage so as to minimize the hazard. If the wreckage still presents a hazard to navigation, it shall be marked until the tender can return with equipment or divers to remove it.

---

**C.4 Wire Sweeping**

For a construction tender, the most effective method of wire sweeping is to spud down with the aid's assigned position forward of the bow. The tender would then deploy the cutter's small boat with a length of wire rope or weighted line. With the bitter end attached to the cutter, the small boat would then sweep an arc of 180 degrees forward of the ship from bow to bow.

---

**C.4.a Length of Wire for Sweeping**

The length of wire rope or line used to sweep will vary based on several factors, including the confidence in the aid's assigned position, the depth of water or any bottom obstructions. This method will be most effective when there are minimal bottom obstructions and less effective in areas where the wire rope sweep may encounter snags (e.g. deadheads, tree stumps, rocks, debris, etc.).

---

**C.4.b TRUB Buoy Position**

Until the location of wreckage is verified, never assume that the TRUB / TRLB set by the ANT is in the correct position. Winds, currents, or a passing vessel could have moved the temporary buoy from station.

---

**C.5 Recovering Wreckage**

Construction tenders must remove the wreckage from destroyed or discontinued aids. The method utilized will depend on the type of aid and composition of piles (i.e. steel, wood or other).

---

**C.5.a Wood Piles**

When hit, wood pile structures will normally break at or below the mud line. The pile, if not floating free or previously recovered by the ANT, can easily be recovered by choking a wire rope sling around the pile and hoisting it on deck. Inspect the lower end of the pile to ensure that it broke below the mud line and that no obstruction remains.

---

**C.5.b Intentionally Breaking**

A construction tender can also intentionally break off an existing wood pile. Rig a long sling, strap or line around the pile and, with sufficient slack, secure the line to a cleat on deck. Bring the pile in contact with the bow of the cutter or barge and ease the ship ahead or astern, as applicable. By pushing against the pile and gradually increasing power, the pile will break below the mud line.

The pile can then be recovered with the crane by lifting with the attached strap or sling.

---

**C.5.c Steel Piles**

Without specialized equipment, steel pile wreckage is more difficult to

---



---

recover. Steel piles can sometimes be removed using a heavy chain ("nipper chain") or heavy wire strap passed around the pile and hooked to the two-part main purchase on the crane. Tension is slowly applied with the main purchase to pull the pile straight up. When pulling piles in this manner, be sure a preventer is hooked into a deck padeye to prevent shock loading the crane should the pile break free of the bottom.

---

**CAUTION!**

**Steel piles must never be run over with the ship or barge. They can bend or break at the water line. This can cause damage to the underwater hull or damage deck fittings on the cutter or barge. This can also make a bad situation worse by creating a more significant hazard to navigation.**

---

**NOTE** *↪*

**Be aware not to overload the crane and exceed the WLL of the system.**

---

**C.5.d Alternate Pile Removal Methods**

The above method alone, however, is usually insufficient to break the suction of the bottom. With upward tension on the pile as above, the follow actions may assist in breaking the suction of the bottom to remove a steel pile.

- (1) A few downward blows on the pile with the hammer may loosen the suction.
  - (2) Pass a length of chain or wire around the pile at deck level. Secure this chain on deck to steady the pile. Work the cutter very slowly fore and aft and side to side.
  - (3) Tap the piling with the bow of the cutter or barge to loosen the suction.
  - (4) Rigging a jetting pipe and forcing water next to the pile may be sufficient to break the suction. Use all water pressure available and keep the jet pipe in motion (i.e., lower it, raise it slightly, and lower again). If you don't keep the jetting pipe in motion it may get stuck making it difficult to retrieve.
- 

**C.5.e Vibratory Driver / Extractor**

If available, a vibratory pile driver/extractor may be an easier method to extract a steel pile. This piece of equipment vibrates the pile and disturbs the soil next to the pile causing the soil particles to lose their frictional grip on the pile. Once clamped to the pile and vibrating, the main purchase can easily pull the pile out of the bottom and hoist it on deck.

---



---

**C.5.f Divers**

If none of the above methods is successful, the last resort is to obtain the services of commercial divers, Navy Mobile Diving and Salvage Units or Army Corps of Engineers divers to help remove the underwater wreckage. Divers must be certified to do underwater cutting and must meet all requirements as per the Coast Guard Diving Policies and Procedures Manual, Volume I, COMDTINST M3150.1 (series) and U.S. Navy Diving Manual (current revision).

---



## Chapter 13

# WTGB with Barge ATON Operations

---

**Introduction** This chapter presents an overview of weight handling operations aboard the 140ft ice breaking tug with barge that currently operate exclusively on the Great Lakes. This chapter is not intended to cover all weight handling situations encountered by these cutters. However, all applicable safety procedures, standard evolution procedures, and sound seamanship practices **shall** be followed whenever engaged in any ATON or weight handling evolution.

---

**In this chapter** This chapter contains the following sections:

Section	Topic	See Page
A	General Information	13-3
B	Standard Buoy Evolution	13-4
C	Special Evolutions	13-12

---



This page intentionally left blank



## Section A. General Information

### Introduction

Two WTGBs (BRISTOL BAY and MOBILE BAY) push 120ft ATON barges equipped with an Appleton Marine model EB150-75-55S hydraulic telescoping crane. The rated hoisting capacity of this crane is 40,000lbs for the four-part main purchase with the whip boom fully retracted and 10,000lbs for the whip boom in all positions. Detailed specifications and information for this crane can be found in Coast Guard Tech Pub 3385.

### A.1 Crane Characteristics

Maximum Swing Range	360 Degrees
Boom Angle (min/max)	0 Deg to 80 Degrees
Boom Length – Main	Fixed – 55'
Boom Length – Whip	Telescoping – 57ft 9in to 75'
Minimum Hook Radius – Main	16ft-4in
Minimum Hook Radius – Whip	13ft-10in
Wire Rope (Main)	385' of 3/4" DYFORM 18
Wire Rope (Whip)	195' of 3/4" DYFORM 18
Minimum Breaking Strength of wire rope is 64,800 lbs	
Maintain a minimum of 5 wraps of wire rope on drums at all times	

### A.2 Deck Winches

The 120ft ATON barge has four hydraulically powered gypsy head winches positioned fore and aft of each buoy port. The four winches can be controlled individually either from a control station located amidships, just aft of the deck crane or by using the local controls at each winch.



This page intentionally left blank



---

## Section B. Standard Buoy Evolution

---

### Introduction

The following section describes the standard evolution for working a buoy from the initial approach and hooking into the buoy, to setting the buoy and moving away. WTGB ATON barges are equipped to conduct the full range of floating ATON work similar to their WLB and WLM counterparts. Prior to executing any buoy deck operations, all weight handling gear shall be inspected and exercised.

---

### B.1 Prior to Work

After the briefing session complete the following:

- a. Where applicable, energize all appropriate deck equipment. Exercise and ensure the proper operation of all buoy weight handling equipment including crane, deck winches, chain stopper and gripes. Permission should be requested from the bridge prior to exercising the crane.
  - b. Rig the bull chain, pelican hooks, snatch blocks, and other applicable deck gear and tools.
  - c. Rig a deck winch to hog chain into the desired chain stopper.
  - d. Rig cross-deck(s) and fairlead blocks for horizontal control of the load.
  - e. Position head blocks, saddles and/or dunnage to receive the buoy.
  - f. Slew the crane/boom outboard toward the center of the working buoy port and spot the hook.
  - g. Remove the lifelines located in the working buoy port. Ensure that the safety chain is rigged.
  - h. When all is ready on the buoy deck, the Buoy Deck Supervisor (BDS) or Safety Supervisor notifies the bridge: "READY ON DECK."
- 

### B.2 The Approach

Shiphandling, specific to working alongside buoys, is covered in Chapter 8 of this manual. The conning officer will inform the BDS or Safety Supervisor whether the buoy will be approached on the port or starboard side. This decision is typically dependant on environmental conditions, deck space availability, and ship's practices.

---

### B.3 The Evolution

The following is the standard evolution for hoisting lighted and unlighted buoys aboard WTGB Buoy Tenders

- a. The bridge will give permission by passing: "HOOK IT WHEN YOU
-





CAN.”

- b. On lighted buoys and larger unlighted buoys, a cageline is passed and tended from the forward part of the buoy deck. The cage line steadies the buoy alongside the buoy port facilitating reeving the hoisting hook.
- c. Reeve the main or auxiliary hoist’s hook into the appropriate buoy lifting bail

NOTE

**Typically a synthetic sling or picking pennant is rove through the buoy lifting bail and secured on the main or auxiliary hoist’s hook.**

- d. Mouse the hook and/or picking pennant once the buoy is hooked.

WARNING

**Mechanical mouse systems SHALL NOT be used on the hook that is rove in the buoy lifting bail.**

- e. When the hook is moused and all personnel are clear, remove the safety chain, hoist the buoy and ease the cage line as necessary until the buoy swings inboard
- f. Lower the buoy hull until it rests slightly on the buoy deck sill. Hook the cross-deck line into the appropriate buoy lifting bail to limit the buoy's horizontal movement and to slew the buoy across deck.

CAUTION!

**The deck winches on the barge are extremely fast. Care shall be taken to not shock load the winches and to maintain control of the load.**

- g. Keep tension on the cross-deck line and shift the cage line to the opposite bulwark/buoy port. Use a combination of the cross-deck line and the crane to slowly maneuver the buoy across the deck – **keeping it low to the deck** – until it’s in position to be lowered into the saddle or appropriate dunnage

NOTE

**The cross-deck and crane should be handled in a way as to provide opposing forces on the buoy as it is slewed across the deck. Care shall be taken to ensure that the crane is not side loaded. The cage line controls the buoy cage on lighted buoys and together with the cross-deck line and crane controls the buoy until it is maneuvered into the saddle (or onto the applicable dunnage for flat bottom buoys) and secured on deck via the appropriate gripe-down gear.**

**WARNING** 

**When a mooring chain is leading over the edge of the deck be alert for a sudden movement of the chain due to unplanned cutter movement.**

- h. Reeve the hogging line hook into the buoy mooring chain near the mechanical chain stopper. Heave around on the hogging line until the chain is in the mechanical chain stopper. Seat the chain in the stopper by striking it smartly with a sledge hammer

**CAUTION!**

**Ensure that the hogging line hook is reeved so that the tip of the hook is pointing up to prevent it from falling out of the chain or from snagging on deck obstructions. Also, slings or Modeer shackles may be necessary when hooking into smaller mooring chain to avoid point loading the hook.**

- i. Set the pelican hook, then slack and remove the hogging line.
- j. Lower the buoy into the saddle; set and seat the head block.
- k. When the buoy is in the saddle and the head block seated, secure it to the deck with the appropriate size and number of gripe chains and ratchet binders/tensors.

**WARNING** 

**Ratchet tie down straps SHALL NOT be used to secure steel buoys.**

- l. After the buoy is properly griped, disconnect the mooring chain from the buoy and replace the safety device.

**WARNING** 

**Personnel are not allowed on the buoy until the buoy is securely griped to the deck and the mooring chain is disconnected. Personnel are not allowed on the buoy when pulling chain.**

- m. The cross-deck line(s) may be slacked or removed. The buoy is now ready to be serviced. Remove the hoisting purchase from the buoy and ensure that it's properly secured.

**B.4 Pulling Buoy Chain**

There are several reasons for pulling chain including, pulling enough chain to facilitate resetting the buoy, inspecting the mooring chain chafe section, verifying position (pulling to short stay), inspecting the sinker, etc. Hoisting buoy chain aboard a WTGB barge involves using the crane to make a series of staged lifts until the desired length of buoy chain is aboard. The following is the standard evolution for pulling buoy chain.



- 
- a. Rig the horse collar, reposition the crossdeck line, and attach a tagline to the end of the chain.
  - b. Request from the bridge, "PERMISSION TO PULL CHAIN", the bridge will reply, "PULL CHAIN."
  - c. Once permission is granted, spot the crane slightly inboard of the chain stopper, hook the appropriate purchase into the chain just inboard of the chain stopper, and trip the pelican hook.
- 

**NOTE** 

**For large size chain, the hook may be inserted directly into a chain link (See Figure 13-1). For smaller sizes of chain use either a rigging shackle of appropriate size, a Modeer shackle, or sling (chain or synthetic) to connect the hook into the chain.**

---

**CAUTION!**

**Exercise care when lifting the chain out of the stopper to prevent shock loading. Constantly monitor the chain during the hoisting evolution to ensure that it is "up-and-down," free of debris, and under no undue strain.**

---

- d. Commence pulling chain after alerting the crew: "STAND CLEAR; PULLING CHAIN." When the desired length of chain is pulled or when the hoist is nearly two-blocked, hook the crossdeck into the chain approximately 2-3 feet above the stopper (See Figure 13-2). Heave around on the crossdeck until the chain is sufficiently led into the jaws plates of the stopper and then lower the hoist so that the chain is properly set in the stopper – the chain is seated by striking it smartly with a sledge hammer.
  - e. Once the chain is seated in the stopper, fake the chain athwartships in the buoy port as the hoist is lowered. As soon as practical secure a bight of chain in the pelican hook.
  - f. Repeat steps (c) through (e) until the desired length of chain has been pulled aboard or until the sinker is a short stay.
-



**Figure 13-1**  
Connecting Cross Deck



**Figure 13-2**  
Pulling Chain

**NOTE**

**Permission must be obtained from the bridge PRIOR to breaking out the sinker from the bottom**

- g. If it's necessary to lift the sinker off the bottom, then continue with steps (c) through (e) until the sinker is at the water's edge.

**CAUTION!**

**In some cases the hoisting purchase alone may not be able to break a sinker free from the bottom. In those cases, secure the mooring chain in the chain stopper and set a pelican hook. Maneuver the vessel around the mooring until the sinker is broke free from the bottom. Once the sinker is free commence pulling chain by repeating steps (c) and (e).**

- h. Remove the horse collar once the desired length of chain has been pulled aboard or when the sinker is at the water's edge.

**B.5 Bringing the Sinker Aboard**

Handling sinkers in a dynamic environment can be one of the most dangerous weight handling evolutions for a WTGB. A successful and safe evolution requires close coordination between the conning officer and buoy deck to provide the most stable platform possible given the environmental conditions. The following is the standard evolution for bringing the sinker aboard

- a. Stage the appropriate dunnage, gripe down gear, crossdeck(s) and necessary steadying lines (large taglines) for the sinker.

**NOTE**

**Permission must be obtained from the bridge PRIOR to bringing the sinker on deck.**

- b. Hook the hoisting purchase into the chain inboard of the chain



---

stopper, mouse the crane hoist hook, and remove the horse collar.

- c. Drop the safety chain and then lift the chain out of the chain stopper. Once the chain is clear of the stopper, maneuver the crane so that the sinker is slid slightly aft of the chain stopper and is tight against the hull. Slowly hoist the sinker until the crossdeck can be attached to the sinker.

**WARNING** 

**The entire length of the mooring chain attached to the sinker is considered LIVE CHAIN – allow no one to step on or move outboard of this chain. Handle chain with chain hooks, NOT HANDS!**

- 
- d. Take a strain on the crossdeck and position the crane slightly outboard of the sinker bail. Hoist the sinker until it clears the buoy port sill.
  - e. Heave around the crossdeck(s) centering the sinker over the dunnage.
  - f. Slowly lower the sinker on the pre-staged dunnage and gripe it in place using at least one gripe chain for routine servicing or two gripe chains for transiting.
  - g. Slew the crane inboard and clear the crane hoist hook.
  - h. Rig the safety device.

**B.6 Hanging the Sinker**

The following is the standard evolution for hanging the sinker over the side.

- 
- a. Attach the mooring chain to the sinker, rig appropriate crossdeck(s) and steadying lines. Hook the hoisting purchase into the pigtail.

**NOTE** 

**Attach the buoy mooring chain to the sinker so that a “pigtail” is created. This is accomplished by shackling a link of chain (3 to 5 links from the end link) to the sinker bail. The shackle clevis is passed through the sinker bail so that the shackle pin will pass through the chain link. The chain link should be “tumbled” in such a way as to ensure that the chain link leading to the buoy will not pinch against the link leading to the pigtail. (Figure 13-3)**



**Figure 13-3**  
**Chain Pigtail**



**Figure 13-4**  
**Sinker Over the Side**

- 
- b. Fake the mooring chain in the buoy port with a bight secured in a pelican hook. Ensure that there is sufficient slack in the chain to allow the sinker to be moved outboard and lowered into the stopper. On longer moorings, rotten stops and rigging a second pelican hook are required. The sinker is always securely gripped to the deck until permission is obtained to hang the sinker.
  - c. Request “PERMISSION TO HANG THE SINKER” from the bridge. The bridge will reply, “HANG THE SINKER.”
  - d. Take tension on the crossdecks and position the crane outboard of the sinker bail.
  - e. Remove the sinker gripes and drop the safety chain.
  - f. Lift the sinker until it is slightly above the buoy deck. While keeping the crossdeck(s) taut, slowly maneuver the crane outboard and walk the sinker slowly until it is clear of the buoy sill. Lower the sinker just below the deck edge, heave around on the crossdeck(s) and pin the sinker snug against the hull.
  - g. Slew the crane inboard to achieve an inboard lead, ease and up and behind the crossdeck(s).
  - h. Maneuver the sinker forward keeping it snug against the hull until the chain is in position to be set in the chain stopper (See Figure 13-4).
  - i. Seat the chain in the stopper, set the pelican hook, and clear the crane hoisting hook. Reposition the crane hoist hook over the buoy.
  - j. Rig the safety chain.

### **B.7 Setting the Buoy**

- 
- a. The following procedure assumes:
    - (1) The mooring chain is in the chain stopper and the sinker is either suspended or on the bottom,
-



- 
- (2) The mooring chain is faked out athwartships in the buoy port with the bights rotten stopped to the bull chain,
  - (3) A pelican hook is rigged with enough chain between the pelican hook and the buoy to facilitate shackling and hanging the buoy.
  - b. Hook the hoisting purchase into the appropriate buoy bail, rig the crossdeck(s) and the cage line (for lighted and large unlighted buoys). Ensure that all of the necessary tools and equipment are staged (split key hammer, sledge hammer, shackle, pin, split key, etc.) for shackling the mooring to the buoy and that all positions are properly manned.
- 

**NOTE** 

**Ensure the hoisting purchase is hooked into the appropriate buoy bail with the hook opening facing forward and moused opposite of the working buoy port.**

- 
- c. Request, “PERMISSION TO SHACKLE AND HANG” from the bridge.
  - d. Once permission is obtained, attached the mooring to the buoy, remove the buoy gripes, and drop the safety chain.
  - e. Buoy deck personnel “man’ their perspective positions and inform the buoy deck supervisor that their positions are manned and ready. For example; “CAGELINE MANNED AND READY.”
  - f. With a slight outboard lead and the steadying lines (cage and crossdeck) taut, the buoy is hoisted and maneuvered toward the working buoy port, under control of the steadying lines and kept as close to deck as possible.
  - g. When the buoy’s counterweight is clear of the buoy deck sill, lower the buoy until the counterweight is below the deck level. Slew the crane slightly inboard to keep the buoy snug against the hull.
    - (1) For unlighted buoys: Continue lowering the buoy over the side until it is at the desired height for deploying.
    - (2) For lighted buoys and large unlighted buoys: Shift the cageline forward of the working buoy port. (It may be necessary to ease the crossdeck to facilitate shifting the cageline.)
  - h. After the cageline has been shifted, ease out and up and behind on the crossdeck simultaneously heaving around on the cage line until the buoy is parallel to the barge’s hull, and lower the buoy hull until it is at the desired height for deploying.
  - i. Maneuver the buoy until it is positioned aft of the buoy port.
  - j. Remove the mouse from the crane hoist hook, unloose the pelican
-



- 
- hooks, and check the chain stopper and pelican hooks' pins for freedom of movement.
- k. When the deck is ready to deploy the buoy, the phrase "READY ON DECK" is passed to the bridge. The bridge's acknowledgement is, "STAND BY."
  - l. The buoy deck supervisor (BDS) directs the appropriate rigger to clear the forward pelican hook, and remove the chain stopper pin. Once the pin is removed that rigger will standby to strike the chain stopper striking plate.
  - m. The bridge will pass, "SET THE BUOY." The BDS then directs the rigger to trip the chain stopper.
  - n. Lower the buoy into the water and remove the hook from the buoy.
  - o. Once the hook is cleared from the buoy, trip the aft pelican hook allowing the remaining mooring chain to pay out over the side.
  - p. For lighted buoys, release and recover the cageline.
  - q. Rig the safety chain.
-





## Section C. Special Evolutions

---

### Introduction

Occasionally, WTGB Buoy Tenders may be required to deviate procedurally from the standard buoy evolution outlined above. These occasions include but are not limited to handling a fouled mooring, working a buoy without lifting bails, searching for and recovering a sunken buoy, and retrieving a beached buoy. Prior to executing any buoy deck operations, all weight handling gear shall be inspected and exercised. Since the following Special Evolutions deviate somewhat from the standard evolution, the Safety Supervisor and Buoy Deck Supervisor shall ensure that all deck crew members are sure of and comfortable with their roles in the evolution

---

### C.1 Fouled Mooring Chain

Twisted (sometimes referred to as kinked) mooring chain often occurs in areas of rotary current or when the buoy swivel is not operating properly. Over time a twist will develop into a knot. A knot in mooring chain generally develops in three different ways: (1) from twisted chain, (2) when the bottom chain wraps around the sinker, (3) when mooring chain becomes fouled with a foreign object.

---

### CAUTION!

**Be aware that a mooring may be fouled with a sunken buoy or other object that could exceed the lift capacity of your weight handling gear.**

---

- a. A variety of tools and equipment are employed when recovering a fouled mooring including, oxygen/acetylene torch, various slings, pelican hooks, Modeer shackles, etc.
  - b. Bringing fouled or knotted mooring chain aboard a vessel greatly increases the usual risks associated with working buoy moorings. Successful recovery of a fouled mooring requires safe rigging practices, patience, ingenuity, and close coordination between the conning officer and buoy deck. While no set of procedures can cover all eventualities when handling fouled moorings, the following general safety procedures will mitigate the risks:
    - (1) Stabilize the situation! As soon as a fouled mooring is discovered set the chain into the chain stopper and set pelican hook.
    - (2) Develop and discuss a recovery plan with the conning officer. Reassess risk and conduct safety brief per Appendix A. prior to commencing the recovery operation.
  - c. The primary goal of the recovery plan is to safely bring the knot or
-



---

fouled section of chain aboard the vessel. Having a knot unravel during the recovery effort could shock load weight handling gear causing serious damage. Therefore hoisting a mooring aboard the vessel from above the knot or fouled section is NOT considered an acceptable recovery method. Instead, the first objective of the recovery is to remove the strain from the knot or fouled section of the chain, in a sense; isolating the knot. The following are some general procedures for handling a knot or fouled mooring:

- (1) Ideally, the best way to isolate the knot is to hook a hoisting purchase into the moor below the knot, usually via a sling. Once the purchase is rigged in this way, the knot can be brought aboard and the chain below the knot secured in the chain stopper or pelican hook. At this point the knot can be removed from the moor by separating (cutting) it from the rest of the mooring.
  - (2) It may not be possible to hook a hoisting purchase into the chain below the knot. In those cases the best alternative may be to have the vessel drag the mooring away from Assigned Position (AP) and release it in safe water.
  - (3) Another less desirable alternative is to “choke” the knot with a sling, hook the purchase into that sling and bring the knot aboard. This method involves more risk as the knot may suddenly unravel, which could shock load weight handling gear causing serious damage.
- d. After the knot or fouled section or mooring has been cleared, standard evolution procedures are followed.

---

## **C.2 Damaged Lifting Bails**

Recovering unlighted nuns and cans whose lifting bails have been damaged or carried away is accomplished using a lasso. A lasso is rigged using a rated eye-and-eye or endless wire rope or synthetic sling. The following are some general procedures for recovering buoys with damaged or missing lifting bails:

- a. The lasso is slung around the buoy hull; boat hooks are used to work the lasso into place. One end of the sling should be placed on the hoisting purchase or otherwise secured on deck.
  - b. Once the lasso is around the buoy hull and attached to the hoisting purchase, the hoist is lowered so that the lasso will work its way below the buoy hull and cinch up on the mooring.
  - c. The lasso will take hold of the mooring just below the buoy and as it is raised will pick up the buoy upside down. The buoy is then brought on board. Because the buoy is upside down, control on deck is very limited. Typically a crossdeck is attached to the buoy
-



---

mooring bail to help control the buoy and guide it into the buoy saddle.

- d. The mooring chain is hogged into the stopper, the pelican hook is set, the buoy is griped, and mooring disconnected.

**CAUTION!**

**The lasso should not be used as a choker around the buoy body due to the potential for slipping. Ensure that the lasso cinches around the mooring chain.**

**C.3 Recovery of Sunken Buoys**

All buoy tenders are called upon from time to time to drag for and recover sunken buoys. In the past, this was a slow, tedious and oftentimes ineffective process. With the incorporation of the Differential Global Position System (DGPS) into the buoy positioning process coupled with electronic charting the probability of successfully locating sunken buoys has significantly increased. The overall evolution of locating and recovering sunken buoys is typically broken down into three separate phases; (1) Dragging operations, (2) Snagging a submerged object, – ideally the sunken buoy – recovering the grapnel hook, and determining what has been snagged, and (3) Recovering the buoy and sinker.

**CAUTION!**

**Due care shall be exercised to ensure that there are no underwater obstructions in immediate area the prior to commencing any dragging operations. Dragging operations shall not be conducted in cable crossings or restricted areas.**

**CAUTION!**

**The largest buoy that a WTGB with barge can safely recover is a 9x35LR. However, the sunken weight of a 9x35LR exceeds the Working Load Limit (WLL) of the weight handling system. Therefore, bringing a recovered sunken buoy hulls aboard these vessels SHALL NOT be attempted until the water has been drained out of the buoy hull. Consult tables 2-7 and 2-8 in the Aids to Navigation Manual - Technical (COMDTINST M16500.3 (series)) for specific flooded buoy weights.**

**C.4 Dragging Operations**

The grapnel hook – sometimes referred to as an anchor hawk – is an integral piece of gear used in the recovery of sunken buoys. Before deploying the grapnel hook however, the deck must be made ready to receive the sunken buoy and mooring. These preparations include but are not limited to: staging crossdeck(s), steadying lines, oxygen/acetylene torch, and other appropriate tools and equipment.



**NOTE** *☞*

**The cross-deck line and crane/boom should be handled in a way as to provide opposing forces on the buoy as it is slewed across the deck. The cage line controls the buoy cage on lighted buoys and together with the cross-deck line and crane/boom controls the buoy until it is maneuvered into the saddle (or onto the applicable dunnage for flat bottom buoys) and secured on deck via the appropriate gripe-down gear.**

The following are the steps for deploying of the grapnel hook.

- a. Attach a section of 1” buoy chain (allowing for a scope of 1.5:1 to 3:1) to a grapnel hook, which weighs approximately 100 pounds.
- b. Fake the remaining 1” chain athwartships in the buoy port.
- c. Secure a bight of chain (approximately 10 feet from the bitter end) in a pelican hook, which is located in the aft buoy port. Stop the bights of chain between the pelican hook and chain stopper to the bull chain with rotten stop as necessary.
- d. Rig a tattle tail in the chain slightly outboard of the pelican hook towards the grapnel hook. The tattle tail is rigged by creating a 2 ft bight in the grapnel hook chain that is secured with a section of 1/2” line. The purpose of the tattle tail is to provide a shock absorber and to alert the buoy deck crew and conning officer when the grapnel hook fetches up on an underwater object.
- e. Request “PERMISSION TO HANG THE GRAPNEL” from the bridge. The bridge will reply, “HANG THE GRAPNEL.”
- f. Once the grapnel is hung, request “PERMISSION TO TRIP THE GRAPNEL” from the bridge. The bridge will reply, “TRIP THE GRAPNEL.”

**NOTE** *☞*

**The conning officer should keep slight way on when the grapnel hook is deployed to avoid have the chain pile atop the grapnel hook.**

**NOTE** *☞*

**Employing a 36” oxygen/fuel torch will enable personnel to decrease the buoy’s sunken weight by cutting a drain hole in the buoy hull before its entire weight is bore by the vessel’s weight handling gear. Although outfitted with less reach than the above torch, an Exothermic cutting torch is typically faster and is effective with the cutting rod underwater.**



- 
- C.5 Conning Tips** The following conning tips may facilitate the safe and successful recovery of a sunken buoy and its mooring:
- a. The search area parameters can be marked either electronically via the Electronic Chart System (ECS), by outlining the area with marker buoys, or by employing both methods.
  - b. In areas with a predominate current, the buoy and its mooring will typically lay parallel to the current either up or down stream from the buoy's assigned position. Dragging across this line produces the strongest possibility of successfully snagging the sunken buoy or its mooring chain.
  - c. As with every evolution involving ship handling, the current should be used to your best advantage. Stemming the current and crabbing 10 to 15 degrees to each side across the current while moving upstream at the end of each pass will increase the probability of success.
  - d. One of the more common mistakes committed when dragging for a sunken buoy is excessive speed of advance, i.e. towing the grapnel hook too fast, which causing it to bounce along the bottom. The chances of recovering a sunken buoy or its mooring are significantly reduced when the grapnel hook is not in contact with the bottom.
  - e. The conning officer must be acutely aware of the ship's proximity to shoal water, obstructions, and other hazards.

---

**C.6 Snagging a Submerged Object** When a grapnel hook fetches up on an underwater object – hopefully the sunken buoy or its mooring – there remains a degree of uncertainty as to what has been actually snagged. For example, while dragging for a 3CR with a single mooring, you may have actually hooked into a 2CR with a double mooring. Therefore, safe and successful recovery of a sunken buoy requires sound rigging practices, patience, ingenuity, and close coordination between the conning officer and buoy deck.

---

**C.6.a Prior to Recovery** Before recovering the grapnel hook and its catch, the 1" chain attached to the grapnel hook must be transferred from the pelican hook to the chain stopper. The following is the standard evolution to affect this transfer:

- (1) Attach a safety shackle into the 1" chain approximately 8 links from the pelican hook towards the bitter end, attach a tagline to the end of the 1" chain, and rig a hogging line leading forward and a crossdeck leading forward and inboard from the pelican hook.



- 
- (2) Request "PERMISSION TO SET THE CHAIN IN THE STOPPER" from the bridge. The bridge will respond "SET THE CHAIN IN THE STOPPER."
  - (3) Once permission is granted, spot the crane/boom slightly inboard of the pelican hook and hook the appropriate purchase into the safety shackle. Attach the hogging line into the 1" chain outboard of the pelican hook and the crossdeck between the hoisting purchase and the pelican hook.
  - (4) Ensure that the tagline is tended and take a slight strain on the hoisting purchase, hogging line, and crossdeck, and trip the pelican hook.
- 

**CAUTION!**

**Exercise care when lifting the chain out of the pelican hook to prevent shock loading.**

---

- (5) Using the crane, hogging line and crossdeck maneuver the chain into the chain stopper.
- 

**NOTE** *↪*

**The conning officer should keep a slight forward lead on the chain to facilitate placing it into the stopper.**

---

- (6) After the chain is set in the chain stopper, refer to the standard evolution for pulling chain – section B.4 of this chapter – until the grapnel hook is at the water's edge.
- 

**C.6.b Water's Edge**

With the grapnel at the water's edge, a clearer assessment of the situation may be possible. In most cases the grapnel hook will have snagged the sunken buoy's mooring chain and so a bight of chain will be draped in one or more of the hook's prongs. Typically the sunken buoy is attached to one end of the chain bight and the sinker is attached to the other end. In this situation, the buoy and sinker must be recovered separately. Therefore, before either can be recovered the mooring chain must be cut.

---



---

**C.6.c Recovering  
Buoy and Sinker**

The overriding consideration for this phase of the evolution is to maintain control of both ends of the mooring chain. As with all buoy deck evolutions, employing sound rigging practices, exhibiting patience, and ingenuity and maintaining close coordination between the conning officer and buoy deck are paramount in ensuring a safe and successful evolution. While no set of procedures can cover all eventualities, the following standard procedures are provided to mitigate the risks:

- (1) Attach a safety shackle into the 1” chain just inboard of the chain stopper jaws, law out the crossdeck and hogging line, and remove the horse collar. Ensure that the bitter end of the 1” chain attached to grapnel hook is secured (see note below).

**NOTE** 

**Two pelican hooks must be rigged; one in the after buoy port and one inboard of the bull chain – this second pelican hook is used to stop off the bitter end of the chain attached to the grapnel hook.**

- (2) Request “PERMISSION TO BRING THE GRAPNEL ABOARD” from the bridge. The bridge will respond “BRING THE GRAPNEL ABOARD.”
  - (3) Once permission is granted, spot the crane/boom slightly inboard of the chain stopper and hook the appropriate purchase into the safety shackle. Attach the crossdeck to the 1” chain inboard of the hoisting purchase.
  - (4) Drop the safety chain and then lift the chain out of the chain stopper. Once the chain is clear of the stopper, maneuver the crane/boom so that the grapnel hook is slid aft of the chain stopper but still at the forward part of the buoy port. Slowly hoist the grapnel hook until it is clear of buoy deck sill.
  - (5) Heave around on the crossdeck as the boom/crane is slewed inboard.
  - (6) When the grapnel hook is over the bull chain or when there is enough slack in the mooring chain, attach the hogging line to the most forward leg mooring chain, and hog it into the chain stopper.
-

**WARNING** 

**Both legs of the mooring chain are considered LIVE CHAIN – allow no one to step on or move outboard of this chain. Handle chain with chain hooks, NOT HANDS!**

- (7) Once the forward leg of the mooring chain is secured in the chain stopper, rig the hogging line with an aft lead.
- (8) Attach the hogging line into the leg of the mooring chain that's aft of the grapnel hook and not already secured in the chain stopper. Maneuver this leg of the mooring chain into the aft stopper or a pelican hook using the hoisting purchase and hogging line.
- (9) When both legs of the mooring chain are secured clear the grapnel hook if possible. (If it isn't possible to safely clear the grapnel hook at this point, then set it on deck keeping a strain on the hoisting purchase.)
- (10) Cut the mooring chain and clear the grapnel hook (if it has not already been cleared). Rig the safety chain and prepare to bring the forward leg of the mooring (the leg in the chain stopper) following standard procedures for pulling chain – paragraph B.5.

**C.6.d. Forward Leg Determination**

If the forward leg of the mooring is attached to the sinker, then follow the standard procedures for bringing the sinker aboard – paragraph A.6

If the forward leg of the mooring is attached to the buoy, then be prepared to bring the buoy on deck up-side-down. The following standard procedures are provided to help mitigate the risks:

- (1) Rig the cross-deck to facilitate bring a buoy aboard, i.e. to maintain horizontal control of the buoy in the buoy port. Set saddle and head blocks as necessary.

**NOTE** 

**Because the buoy may be brought aboard up-side-down and backwards, the head block may need to be deployed between the buoy saddle and the working buoy port – opposite of its normal position.**

- (2) Request "PERMISSION TO BRING THE BUOY ABOARD" from the bridge. The bridge will respond "BRING THE BUOY ABOARD."
- (3) Once permission is granted, spot the crane slightly inboard of the chain stopper, hook the appropriate purchase into the safety shackle, and attach the cross-deck into the mooring chain inboard





---

of the hoisting purchase.

- (4) Hoist the buoy until the buoy body clears the buoy deck sill, slew inboard, and heave around on the crossdeck.

**WARNING** 

**The sunken weight of some buoys may exceed the WLL of crane. Therefore, allow the water to drain from the buoy prior to bringing it aboard. In some cases, a hole will have to be cut in the buoy hull to facilitate the water draining from the buoy.**

- (5) Use a combination of the cross-deck line and the crane/boom to slowly maneuver the buoy across the deck – **keeping it low to the deck** – until it's in position to be lowered into the saddle or appropriate dunnage.
- (6) Once the buoy is in the saddle or appropriate dunnage follow the appropriate standard evolution procedures for bring the buoy aboard – section B.3.

After the forward leg of the mooring has been successfully recovered, recover the aft leg. If the aft leg is in a pelican hook, transfer the aft leg to either the forward or aft chain stopper. Once this has been done, recover the leg following the procedures outlined in section B.3.

**C.7 Recovery of Buoys Ashore**

---

A WTGB buoy tender may be called upon to recover a buoy that has washed ashore. Typically a shore party is debarked to assess the buoy's condition. The shore party's primary missions are to ensure:

- a. That the buoy's structure is sound and that it will not sink during towing operations.
- b. That the buoy is disconnected from its mooring and free from any obstructions that would hinder the towing operation.
- c. That the towline is properly rigged. The towline shall be of sufficient size and strength and is attached to one of the buoy's lifting bails.
- d. Once the buoy has been properly rigged for towing, the buoy is towed out into the water.

**NOTE** 

**The vessel's towing bill and appropriate safety procedures shall be followed during towing operations.**

---

When the buoy is towed into an area deemed safe for recovery by the Commanding Officer, then the buoy is retrieved using the procedures outlined in section B.3 of this chapter. The vessel's towing bill and

---



---

appropriate safety procedures shall be followed during towing operations.

---

**NOTE** *↪*

**When transitioning from the towing bill to the ATON bill, the towline shall be constantly tended by competent personnel to ensure that the towline does NOT become fouled with the vessel.**

---



This page intentionally left blank



## Chapter 14

# ATON Operations from Boats

---

### Introduction

Aids to Navigation (ATON) boats, either deployed from a cutter or Aids to Navigation Team (ANT), are designed to service floating or shore side aids that larger cutters cannot access or do not require the physical presence of the cutter to conduct the required servicing. ATON boats range in size from small ridged hull inflatable boats to the 64' Aids to Navigation Boats (ANBs). Some are outfitted with heavy lifting equipment while others are used primarily for personnel and equipment transportation.

---

### In this chapter

This chapter contains the following sections:

Section	Topic	See Page
A	General Boat Information	14-3
B	Personnel Deployment	14-5
C	Towing Buoys with Boats	14-9
D	Wire Sweeping with Boats	14-13
E	Buoy Operations from Boats	14-17

---



This page intentionally left blank



## Section A. General Boat Information

---

<b>Introduction</b>	This chapter contains generic information covering the range of ATON related boats used in the Coast Guard.
<b>A.1 Standard Boats</b>	Primary ANT boats (26', 49', and 55') and their respective standard evolution are not covered in this chapter. The standard evolution for those boats is covered in the applicable Boat Operator's Handbook: <ul style="list-style-type: none"><li>(a) 26' Trailerable Aids to Navigation Boat Operator's Handbook, COMDTINST M16534.1 (series)</li><li>(b) 49' Buoy Utility Stern Loading Boat Operator's Handbook, COMDTINST M16114.22 (series)</li><li>(c) 55' Aids to Navigation Boat Operator's Handbook, COMDTINST M16534.2 (series)</li></ul>
<b>A.2 Non-Standard Boats</b>	The Non-Standard Boat Operator's Handbook, COMDTINST 16114.28 (series) contains general requirements, guidelines, and information for boat crews to improve safety and effectiveness of non-standard boat operations. However, this handbook does not provide mission specific information.
<b>A.3 Training and Qualification</b>	Boat training and qualification procedures/requirements are contained in the U.S. Coast Guard Boat Operations and Training (BOAT) Manual Volume I, COMDTINST M16114.32 (series) and Volume II, COMDTINST M16114.33 (series).
<b>A.4 Boat Seamanship</b>	General boat seamanship information is contained in the Boat Crew Seamanship Manual, COMDTINST M16114.5 (series).
<b>A.5 Special Considerations</b>	Special consideration should be kept in mind with regard to stability and weight handling aboard these boats. Due to their smaller size, care must be taken to prevent capsizing from environmental conditions (current, wind, seas), improper deck storage or excessive deck load limits. <b>Gear shall be properly secured at all times.</b>

---



This page intentionally left blank



## Section B. Personnel Deployment

---

**Introduction** One of the primary missions for ATON boats is to transport servicing personnel and/or equipment to an aid. Whether carrying out discrepancy response or scheduled maintenance, ATON boats with their shallower drafts, greater speed/maneuverability, and reduced operating costs can service a large number of aids allowing larger cutters to carry out other missions.

---

**B.1 Floating Aids** Transferring personnel and equipment between a boat and a floating aid requires steady boat handling and good communication between the coxswain and ATON technicians. Since the environmental conditions (current, wind, seas) affect the boat differently than the buoy, approaching the buoy and timing the transfer requires practice and coordination. The following steps shall be utilized when transferring personnel from a boat to a buoy:

- a. Upon arrival, circle the buoy (if conditions allow) looking for any debris (above and below waterline) that would impede your approach.
- b. Watch the buoy's movement in the water. Pay particular attention to how the buoy rolls and behaves in the seas.
- c. Coxswain and servicing crew discuss how the approach will be made and where the transfer will take place.
- d. Conduct a deliberate risk assessment and discuss results before beginning the approach.

**NOTE** 

**In most cases, the coxswain will approach the buoy heading into whichever element (current, wind, seas) is having the strongest effect on the boat. The servicing crew will generally cross over to the buoy from the boat's bow.**

- e. Coxswain approaches the buoy and informs the servicing crew when it is safe to transfer over to the buoy.

**NOTE** 

**If equipment is to be transferred between the boat and buoy, place one person on the buoy and then transfer the equipment rather than trying to jump the buoy carrying the equipment. Servicing personnel should NOT remove any PPE prior to the transfer and have both hands free to grab onto the buoy during the transfer.**





- f. Once servicing personnel are safely on the buoy, coxswain makes additional approaches as needed to transfer equipment. The use of tag or tending lines is highly recommended to ensure equipment is not lost.

**NOTE** 

**If conditions permit, the boat may tie off to the buoy to assist with personnel and equipment transfers. Caution should be used to ensure the boat and aid are not damaged from repeated contact together and that the buoy could be dragged off station by the extra strain on the mooring.**

**CAUTION!**

**The boat SHALL NOT leave the area while a servicing crew is working a buoy. The boat will remain on scene to provide support if needed.**

**CAUTION!**

**Boat crews shall not tie off to an aid and abandon the boat to service an aid to navigation. At a minimum, a certified crew member shall remain in the boat at all times.**

- g. Once service to the buoy is complete, the boat approaches the aid to recover any equipment and servicing personnel. If conditions have changed while the aid was being serviced (current/wind/wave direction), the coxswain shall re-evaluate the conditions and pass the new plan for approach and pick-up to the servicing crew.

**NOTE** 

**The coxswain should always monitor local conditions. If conditions deteriorate making service crew recovery or boat return questionable, servicing should be stopped and/or not attempted.**

**B.2 Fixed Aids**

While fixed ATON structures do not move like a buoy, they still can offer quite a challenge to approach and service. Often there is only one access point (ladder) which may not be positioned in the best location for the current environmental conditions. It may be necessary to drop personnel off at one location (ladder) but better to transfer equipment from another (downwind/current from aid). Also, there may be limitations due to surrounding hazards (rocks, shoals, etc.) that do not allow access to the aid from some directions.

As with floating aids, a detailed risk assessment of all on-scene conditions shall be conducted by the boat crew. While some special circumstances may require different approach tactics, in most cases the



---

procedures for transferring personnel and equipment to a floating aid apply to working a fixed aid.

---

**NOTE** 

**One benefit of working a fixed aid is that once the boat is in contact with the structure, a small amount of power can be applied to assist with keeping the boat in position (conditions permitting). Caution should be used however – too much power could cause damage to the boat and/or structure.**

---

**B.3 Shore Aids**

Often boats are the preferred method for accessing shoreside aids. Limited or no access from shore, ease of equipment transportation, and speed of response compared to shoreside access make boat-to-shore operations an important skill for boat crews.

While grounding a boat is something coxswains would prefer not to do, sometimes it is required to access some aids and can be done safely with minimal risk to the boat and crew. Learn as much about the aid and area you will be operating in, detailed information regarding service by boat (preferred access points, charts, local knowledge, etc) should be maintained in the aid's record.

As with floating and fixed aids, a detailed risk assessment of all on-scene conditions should be conducted by the boat crew before attempting the operation. The below steps shall be utilized when deploying personnel from a boat to either shore or a jetty/breakwall to service an aid to navigation:

- a. Upon arrival, assign crew duties and brief plans for the operation based on risk assessment.
  - b. Place lookout(s) in a safe location(s) where they have a clear view in front of and behind the boat. Lookouts can also have a boat hook (or similar device) to assist with depth sounding or pushing off obstructions.
  - c. If the boat is an inboard/outboard or outboard, trim up the lower-unit /out-drive to a point where maneuverability is maintained but the boat's draft is reduced.
  - d. Approach the landing point at a slow speed.
  - e. Once contact with the shore has been made, determine if that location will be safe to offload equipment and personnel. If landing point is unsatisfactory, slowly back away to clear water.
  - f. Once it is determined that the boat's location will be safe for offloading equipment and personnel, begin the transfer.
-



**NOTE** 

The movement of personnel and equipment will change the draft of the boat. If possible, a small amount of power can be applied to the engine to ensure the bow stays in contact with the landing point.

**CAUTION!**

Pay particular attention to the boat's stern and propulsion system. Wind or currents may cause the stern to swing towards hazards making departure difficult or impossible. Maintain a position perpendicular to the shore keeping the boat's propulsion system in safe water. The use of a small anchor positioned off the stern may be necessary.

**WARNING** 

**Do not attempt to beach a boat in any kind of surf condition. ATON Boats are not designed for operations in the surf!**

- g. Once equipment and personnel have been transferred, back the boat away from shore slowly following the same path used for the approach.



## Section C. Towing Buoys with Boats

---

### Introduction

The decision whether or not to tow a buoy depends greatly on the situation. Towing a free-floating buoy from one boat to another is completely different from towing a buoy that still has its mooring attached or attempting to re-float a grounded buoy. Each situation must be thoroughly reviewed and a detailed risk assessment must be conducted and discussed.

---

### NOTE

**Additional information regarding towing with boats can be found in the Boat Crew Seamanship Manual, COMDTINST M16114.5 (series).**

---

### C.1 Floating Buoys

Towing a free-floating buoy (no mooring) can be a challenge. How the buoy **moves** through the water depends on its shape and size. While buoys are predominantly round in shape allowing for relatively smooth movement through the water, larger lighted buoys have counterweights that hang many feet below the waterline. Towing the buoy astern is the best option, but alongside is possible for close quarters maneuvering. Some considerations for towing free-floating buoys are:

- a. Towline(s) should only be attached to the buoy's lifting bail and not to the cage or other appendage.
  - b. Always ensure the boat that is conducting the tow has the power to successfully complete the mission.
  - c. Ensure the buoy is watertight and all battery pocket covers are secured in place.
  - d. For larger lighted buoys with deep counterweights, make sure there is sufficient water depth to tow the buoy and that it will not become fouled or run aground.
  - e. If towing a long distance, consider deploying a drogue from the buoy to assist with stability and reduce yawing.
- 

### C.2 Grounded Buoys

For buoys that have either broken free from their mooring or have been dragged ashore, the possibility of re-floating the aid by towing exists. The buoy's location, physical condition (damaged, holed, etc.), size, asset availability and crew safety are primary factors to consider when attempting to re-float a buoy. Using a truck and crane or a helicopter might be better alternatives to hazarding a boat and crew.

---

**WARNING** 

**Attempting to re-float a grounded buoy is extremely hazardous! Operational risk management procedures shall be followed before any attempt is made.**

When re-floating a grounded buoy consider the following:

- a. If it will be a while before re-floating is attempted, consider rigging an anchor(s) (if mooring is missing/damaged) to prevent the buoy from being pushed further ashore.
- b. Conduct a thorough inspection of the buoy. Ensure the aid's hull is in satisfactory condition and will not sink if re-floated.
- c. When ready to tow, detach the mooring (if possible). If unable to detach mooring, determine where the chain and sinker are in relation to the buoy and how they might affect the towing operation.
- d. Remove any/all hardware (lanterns, solar equipment, etc.) to prevent further damage.
- e. Determine which direction the buoy will be towed. Try to pick a route that is clear of obstacles such as rocks, shoals, reefs.
- f. Re-float the buoy at high tide.

**C.3 Towing Buys With Mooring Attached**

While it is always best to hoist a buoy's mooring clear of the bottom before attempting to re-position, towing a buoy (including mooring) might be necessary at times. Two examples of when you would need to tow a buoy with its mooring are: if a buoy tender is not be able to get to the buoy ( i.e. water depth/shoaling) or if the aid is reported off station and the primary servicing unit is not available to recover the aid prior to it being washed ashore.

**WARNING** 

**Attempting to tow a buoy with its mooring still attached is extremely hazardous! Operational risk management procedures shall be followed before any attempt is made.**

Things to consider before attempting to tow a buoy with its mooring attached:

- a. Determine the aid's mooring length/size from records.
- b. Use a boat with sufficient power and equipment to tow the buoy and mooring.
- c. Determine how far the buoy needs to be towed. In some circumstances, it might be better to tow the buoy a shorter distance into



---

safe water allowing it to be recovered by a larger cutter.

- d. If attempting to tow the aid back on station, locate the assigned position first with a marker buoy. This will serve to provide a heading for the boat crew to steer toward.
- e. Ensure the direction of the tow will not drag the sinker over any submerged cables/pipelines.
- f. Once hooked up, take a slow strain to determine if the buoy's sinker is still attached.
- g. DO NOT tow the buoy into an area where the water depth exceeds the length of the mooring.

**WARNING** 

**Buoy towing operations require connecting the towline to an acceptable and rated fitting designed for towing. NOT using the appropriate fitting may damage the boat or cause serious injury to crewmembers.**



This page intentionally left blank



## Section D. Wire Sweeping with Boats

---

**Introduction** Whenever a structure has been destroyed (severe weather, ice, collision, etc.) the wreckage must be located and recovered at the earliest possible opportunity. If not recovered (or adequately marked), it could become a hazard to navigation and place a severe liability burden on the Coast Guard. One method to locate submerged wreckage is by wire sweeping the area with either one or two boats.

---

**NOTE**  **While wire sweeping is primarily used to locate the wreckage from a structure, it can also be used to locate sunken buoys.**

---

**D.1 Overview** When using either method of wire sweeping, be patient and persistent. While there is a chance that a wooden aid may have floated away after it has been knocked down, it may also have broken above the mud line leaving a stump that can cause severe damage to a vessel that strikes it. There is never any doubt where the remains of a steel or concrete structure are; they're on AP. Your job is to find them. It's not uncommon to search for hours, or even days, for a downed structure. In most cases the structure can be located, either on AP, or if it's wooden, it may have drifted to a nearby shore. It cannot be said too often, or emphasized too strongly, that we must employ every method at our disposal to locate and remove the wreckage of destroyed ATON structures. Side scan sonar is an ideal tool if it is available to the unit. If you are unable to locate the wreckage via boat, it may be necessary to bring in divers. Again, steel or concrete wreckage **must** be located.

---





**D.2 Sweeping with One Boat**

Using one boat method, the boat tows either a grapnel, wire sling, or utilizes a trawl board wire sweep rig over the search area **at a slow speed**. The preferred method (and the one that covers more bottom area and has a better chance to locate the wreckage) is the trawl board method. This rig consists of two small wooden or metal trawl boards, similar to those used on commercial fishing boats, towed behind the boat off of each quarter. These boards are weighted so they will sink to the bottom and are attached to the bridle in such a manner that when pulled they are forced apart, thus providing an opening of approximately 20 feet between the boards. A small wire rope cable (i.e., 1/4") approximately 60' long is stretched between the boards and will drag the bottom hanging on the wreckage. After the wreckage is located (normally by the boat being stopped), the boat then pulls back to the boards and the wire cable is disconnected from the boards. One eye of the cable is then passed through the other and pulled tight. Like the two boat method, a small marker buoy, or TRUB/TRLB, is attached to the end of the cable. When the Construction Tender arrives to rebuild the aid, it will use the wire to assist in recovering the wreckage (see **Table 14-1 and Figure 14-1**).

Water Depth	Width of Sweep	"A"	"B"	"C"
Up to 14'	35'	25'	100	50'
Up to 14'	60'	25'	125	75'
Up to 20'	35'	35'	125	50'
Up to 20'	60'	35'	150	75'

"A" – Float Lines (3/8" Hemp or Synthetic)  
 "B" – Trawl Lines (3/8" to 1/2" Hemp or Synthetic)  
 "C" – Wire Rope (3/16" Diameter)

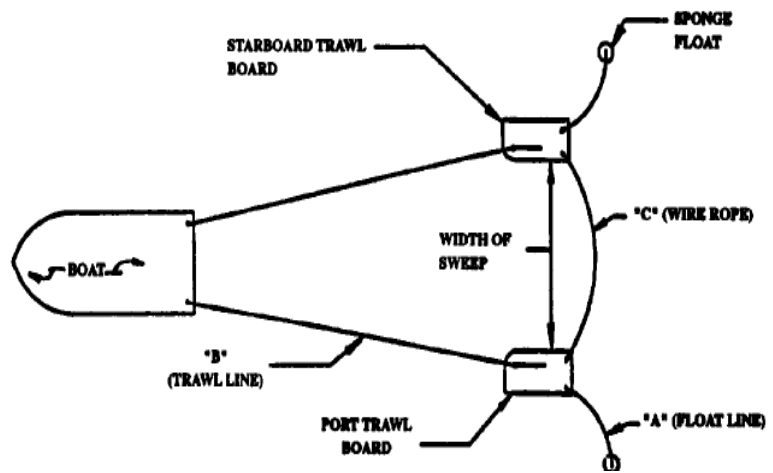

**Figure 14-1**  
**One Boat Wire Sweeping Diagram**

**Table 14-1**  
**One Boat Wire Sweeping Dimensions**



**D.3 Sweeping with Two Boats**

This consists of two boats running parallel courses at slow speed with either a wire cable (normally 1/4" - 3/8") or small chain (3/16" - 1/4") strung between the boats. The wire cable, or chain, dragging the bottom will hang on the obstruction, stopping the movement of the boats. After the boats have pulled back to the location of the wreckage, they then pass one end of the cable (both ends have eye splices) through the other eye and tighten the cable. The cable is then buoyed with a small marker float, or TRUB/TRLB, and left for the Construction Tender to recover. The Construction Tender will either utilize the cable to recover the wreckage or as an aid to pass a larger wire or chain around the wreckage before recovery (see **Table 14-2** and **Figure 14-2**).

Water Depth	Width of Sweep	"A"	"B"	"C"
Up to 14'	35'	25'	100	50'
Up to 14'	60'	25'	125	75'
Up to 20'	35'	35'	125	50'
Up to 20'	60'	35'	150	75'

"A" – Float Lines (3/8" Hemp or Synthetic)  
 "B" – Trail Lines (3/8" to 1/2" Hemp or Synthetic)  
 "C" – Wire Rope (3/16" Diameter)

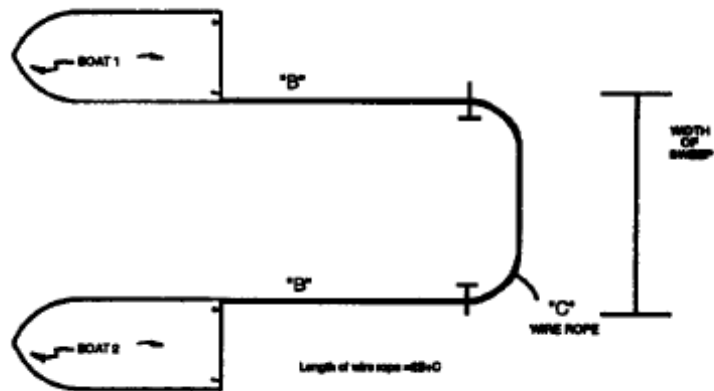

**Figure 14-2**  
Two Boat Wire Sweeping Diagram

**Table 14-2**  
Two Boats Wire Sweeping Dimensions



This page intentionally left blank



## Section E. Buoy Operations from Boats

**Introduction** Buoy operations are inherently dangerous and are best accomplished from boats with installed weight handling gear; buoy davit, “A” frame boom, or articulating crane. Buoy evolution procedures for those boats are contained in the appropriate Boat Operators Handbook (BOH).

**NOTE** *↪* **Normal buoy operations should only be performed from boats assigned to ATON units.**

**E.1 Overview** A situation may exist when ATON boats without installed weight handling gear will be required to conduct buoy operations by hand. In those rare cases, the unit CO/OIC may grant specific authorization to conduct the evolution. Authorization shall not be granted unless ALL of the following criteria are met:

- a. Conduct a deliberate risk assessment and discuss all hazards and any mitigating strategies prior to the evolution.
- b. The buoy shall be 5<sup>th</sup> class or smaller (foam or plastic).
- c. The mooring shall NOT be larger than ½ inch diameter.
- d. The sinker shall NOT be more than 100 pounds (dry weight).
- e. The water depth (on scene position) shall NOT exceed 25 feet.

**E.2 Recovering the Buoy** The following are basic procedural steps for recovering a buoy and mooring by hand:

- a. Bring the buoy onboard, stop off the mooring, break the buoy from its mooring and secure the buoy.
- b. Bring the mooring to short stay by hand (utilizing the hand-over-hand method), record the “found” position and determine if the sinker can be broken out by hand.
- c. If sinker can be broke free by hand, bring the sinker onboard and secure it. Otherwise, rig an appropriate size safety line between the buoy mooring and a suitable attachment point on the boat and break the sinker free from the bottom with the boat. Once free, bring the sinker onboard and secure it.

**WARNING** 

**Use extreme caution when using the boat to “break free” the sinker. The low freeboard, excessive power or even the lightest of current can cause the boat to swamp or capsize when driving on a sinker.**

**E.3 Setting the Buoy**

The following are basic procedural steps for setting a buoy and mooring by hand:

- a. Hang the sinker, ensure it is below the bottom of the boat, and temporarily secure using rotten stop (small stuff) to a suitable attachment point on the boat and connect chain to buoy.
- b. Deploy the buoy; pay out chain using hand-over-hand technique until all chain is carefully over the side.
- c. Over AP cut rotten stop to sinker and record “set” position.

**E.4 Precautions**

Always observe the following safety precautions when conducting buoy operations by hand from boats:

- a. Position an additional crewmember within reach of the person actually handling the buoy and/or mooring to serve as a safety observer or back up. They shall be ready to assist the person in an extremis situation or to prevent injury to personnel or equipment.
- b. Appropriate gloves shall be worn to help protect the hands of personnel handling or may be handling the buoy, mooring, and/or sinker.

**WARNING** 

**A buoys mooring shall NEVER be wrapped around any part of a person’s body.**

**CAUTION!**

**The CO/OIC and boat coxswain will ensure strict adherence to the parameters, criteria, procedures, and safety precautions outlined in this section when recovering or setting a buoy by hand.**

**NOTE** 

**This Section only applies to ATON boats without installed weight handling equipment. No other variations to the standard ATON evolution for ATON boats are authorized.**

## ATON Deck Safety Brief

### General Emergency (What to do?)

- GE alarm
- Hydraulic failure (location of emergency stops)
- Man Overboard (injured/un-injured, Buoy side/other side)
- Personnel injuries (Report any injury, no matter how slight)

### Personal Protective Equipment

- Proper Color Hardhat W/Chinstrap
- Safety Glasses
- PFD W/whistle and chemlight or strobe light (Inflatable PFDs cannot be worn while working ATON)
- Gloves
- Knife
- Safety toe boots
- Special protective gear for cutting/welding, battery maintenance etc.

### General Safety

- Emergency stop signal and verbal command (“AVAST”!)
- Escape Routes, hard spots, live chain, being aware of surroundings
- Use back up's when leaning over buoy port
- Use of chain hooks
- Tend line faked out in front of you
- No throwing/kicking gear across deck
- Discuss any discrepancies from daily check-offs
- Commands (Volume, terminology, call backs, “COMMAND” if not understood)
- Don't turn back to the load
- No watches, rings, necklaces or other types of jewelry

### Job Assignments

- Positions assigned normally for all day
- Shadowing green hats by blue hats

### Aid being Worked Specifics

- History/Type of Aids to be worked
- Size/Type/Depth of mooring
- Prior fouled moorings or other previous issues
- Hot packed?
- Riding low/Partially sunk
- Damaged light gear, solar panels etc.

GAR Model		
Supervision		
Planning		
Environment		
Event/Evolution		
Crew Selection		
Crew Fitness		
Total:		
G: 0-22	A: 23-43	R: 44-60

### GAR Briefing conducted on the Bridge and the Buoy Deck

Bridge and Buoy Deck GAR results shall be compared and any issues shall be discussed between the Bridge and Buoy Deck.

BDS: \_\_\_\_\_

Date: \_\_\_\_\_





This page intentionally left blank

## Crane Hand Signals and their definitions

Boom Up	Boom Down	Heave around on the whip (single part)
		
Heave around on the main (two-part purchase)	Pay-out on the main (two part purchase)	Pay-out on the whip (single part)
		
Slew Left/Right (the direction the hand is pointed)	Extend Boom (for cutters equipped with telescoping booms)	Retract Boom (for cutters equipped with telescoping booms)
		
Boom down and heave around (one finger for whip/two for the main)	Boom up and pay-out together (one finger for the whip/two for the main)	Heave around slowly (thumb and fore-finger tapping together), pay-out is the same, put pointed down
		



### Crane signals and their definition (cont.)

<p>Pay-out or Heave around on the chain inhaul winch (depending on the buoy port in use). Point towards the buoy port in use is the signal to pay out.</p>	<p>Slew port or starboard on the level wind-arm for the in-haul winch.</p>	<p>Heave around on the cross-deck winch (dependent on the cross-deck in use). Arm is bending up and down at the elbow. BDS will first point to the cross-deck he or she desires to use.</p>
		
		<p>Pay-out on the cross-deck winch (dependent on the cross-deck in use). Arm is bending up and down at the elbow. BDS will first point to the cross-deck he or she desires to use.</p>
		